

Rogowski current transformer and measurement transducer

$$V_{out} = -M \cdot \frac{dI_P}{dt}$$

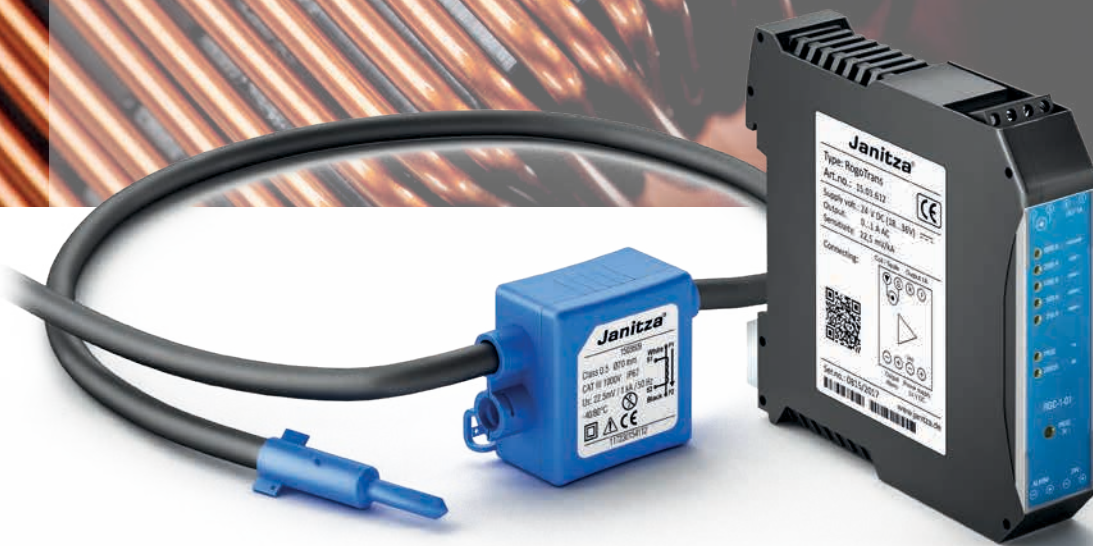

ROGOWSKI CURRENT TRANSFORMER AND MEASUREMENT TRANSDUCER

Rogowski current transformer and measurement transducer

The Rogowski coil principle

The Rogowski measuring principle is a special form of transformational current measurement of sinusoidal and non-sinusoidal alternating currents.

The Rogowski coil is a patented, iron-free induction coil (air coil). In order to attain ideal accuracy, this air coil should be almost completely closed. This has been achieved through the patented connection technology.

- Record harmonics and transients with phase precision
- Flexible Rogowski current transformer suitable for retrofitting
- Alternating currents from 1-4000 A can be recorded with just one variant
- Rogowski current transformers with measurement transducer can be used together with all Janitza UMGs*
- Install and operate safely

* Not in combination with the UMG 20CM

The alternating current in the line that is to be measured induces a voltage in the Rogowski coil, which is proportional to the phase current. The Rogowski coil operates in a pronounced linear manner, even with high or rapidly changing currents. As such, this type of sensor is particularly well suited for energy measuring systems that are exposed to high or rapidly changing currents. Furthermore, the Rogowski coil offers the advantages of compact size and simple installation.

- Speed because load changes are immediately detected and so drop-outs and process interruptions can be prevented
- Simple operation also with large cable diameters – space-saving, compact and handy
- High system availability through simple installation without removing system parts
- Sits securely on power rails and round conductors thanks to professional fastening

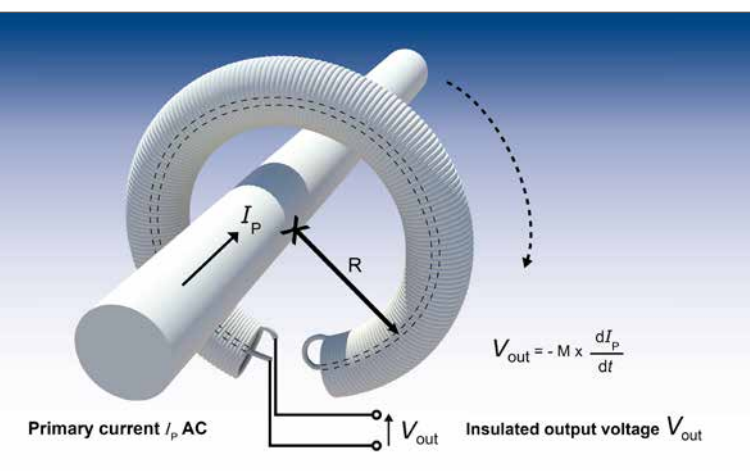

The Rogowski coil is a helical wire coil.
It can be guided easily around a conductor.

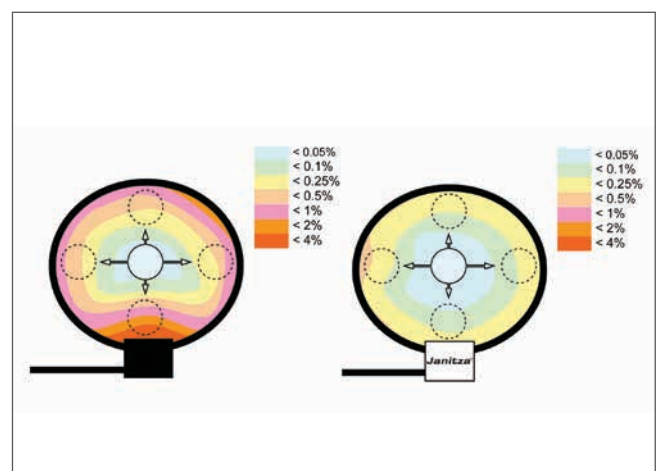

Comparison of current transformer accuracy between a conventional Rogowski current transformer and the patented Janitza solution with consideration to the installation position

Rogowski current transformer and measurement transducer

Rogowski coil – thinner, lighter flex converter for simple installation

The Rogowski coil is used for current measurement of AC currents and is primarily employed for retrospective installation in existing systems - optionally on power rails or power cables.

- Frequency bandwidth of the Rogowski coil 50/60 Hz, up to 700 kHz without load (no-load operation)
- Accuracy per class 0.5, in accordance with IEC 61869
- Operating temperature: -40°C to +80°C
- Rated insulation voltage 1 kV CAT III
- Rogowski coil from 10 to 10000 A_{RMS} – in combination with Janitza measurement transducer RogoTrans up to 4000 A_{RMS}
- Accuracy better than 0.65 % irrespective of the position of the primary conductor
- Sealing possible

Retrospective installation around the primary conductor is possible, because the Rogowski coil can be separated. The output signal from the Rogowski coil is fed to a measurement transducer, which issues standardised AC current of max. 1 A at the output.

- CE-certified (2014/30/EU), in accordance with the European Directive 2014/35/EU and tested in accordance with the standard IEC 61010-1
- Unique, IP67, flexible and precise AC current transformer with separating core, based on Rogowski coil technology
- Retrospective clip-on system without disconnecting the phase conductor
- Device for fixing to the primary conductor with a cable tie
- Internal screening
- High linearity, no saturation, no current upper limit of the Rogowski coil

The operation of the Rogowski coils as per the technical data mentioned herein can only be assured in combination with Janitza measuring transducer "RogoTrans".



Rogowski current transformer and measurement transducer

Rogowski current transformer – the time-saving installation



Sealed and mounted on the phase conductor with a cable tie

Versatile – Rogowski current transformer in application

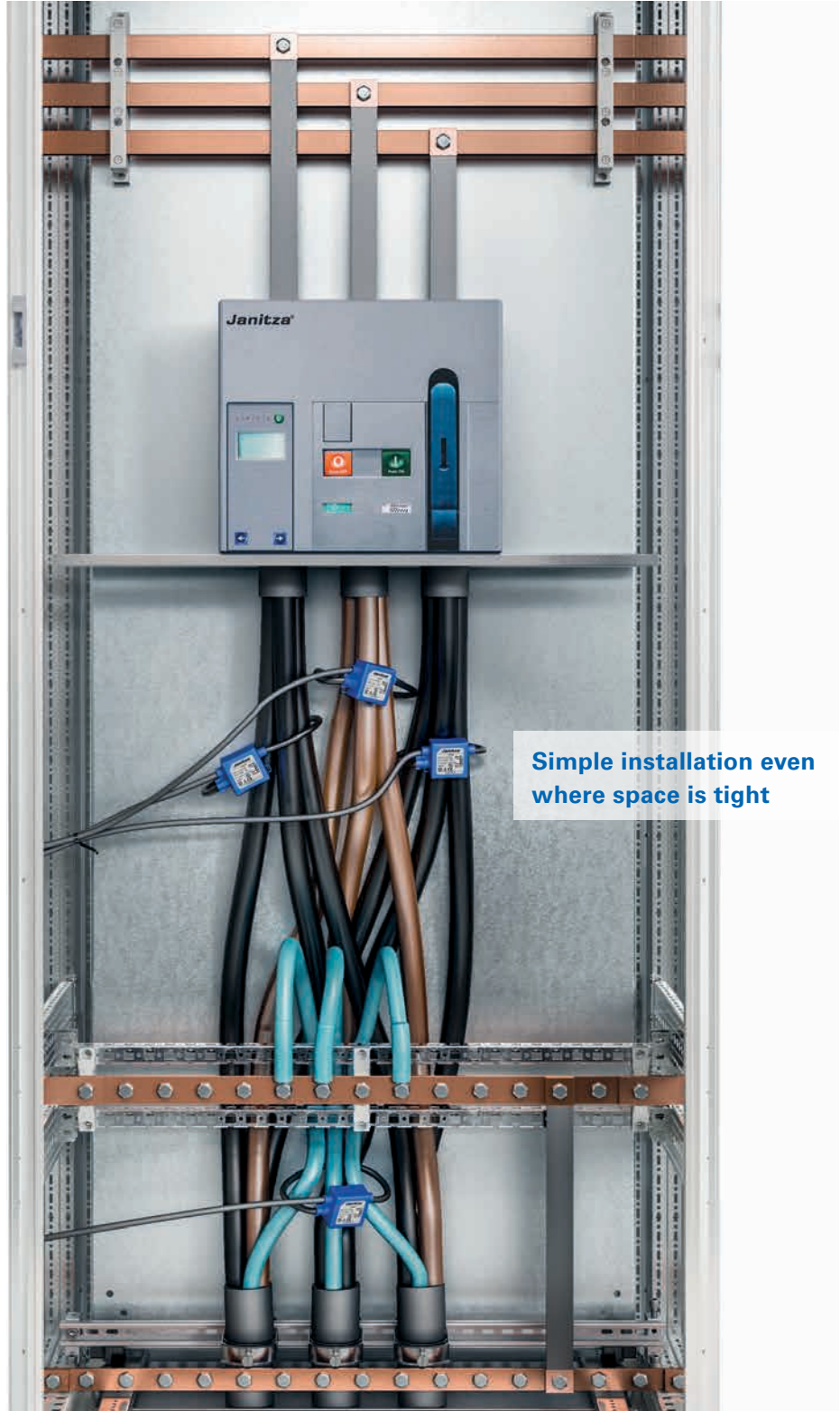

Also easy to install with tight spatial conditions and parallel feed

Rogowski current transformer and measurement transducer

The operation of the Rogowski coils as per the technical data mentioned herein can only be assured in combination with Janitza measuring transducer "RogoTrans".

| Rogowski coil, item no. | 15.03.609 | 15.03.610 | 15.03.611 |
|--|--|--|--|
| Diameter | 70 mm | 175 mm | 300 mm |
| Length of the connection line | 3 m | 3 m | 3 m |
| Max. output voltage | 30 V | 30 V | 30 V |
| Primary current ^{*1} | Up to 10000 A ^{*1} | Up to 10000 A ^{*1} | Up to 10000 A ^{*1} |
| Rated transformation ratio (@ 50 Hz) | 44.44 kA/V | 44.44 kA/V | 44.44 kA/V |
| Rated frequency | 50/60 Hz | 50/60 Hz | 50/60 Hz |
| Secondary voltage | 22.5 mV (at 1000 A / 50 Hz) | 22.5 mV (at 1000 A / 50 Hz) | 22.5 mV (at 1000 A / 50 Hz) |
| Mutual inductance | 71.98 nH | 72.314 nH | 72.84 nH |
| Temperature coefficient of M | ±30 ppm/K | ±30 ppm/K | ±30 ppm/K |
| Frequency bandwidth (cable length 1.5 m) ^{*2} | 420 kHz ^{*2} | 350 kHz ^{*2} | 300 kHz ^{*2} |
| Phase displacement (@ 50/60 Hz) ^{*3} | 0.004° ^{*3} | 0.004° ^{*3} | 0.004° ^{*3} |
| Coil inductance | 180 µH | 343 µH | 566 µH |
| Coil resistance | 56 Ω | 105 Ω | 170 Ω |
| Ratio error (centred) | - 0.5 to 0.5 % class 0.5 Accuracy per IEC 61869-2 | - 0.5 to 0.5 % class 0.5 Accuracy per IEC 61869-2 | - 0.5 to 0.5 % class 0.5 Accuracy per IEC 61869-2 |
| Ratio error (all positions) ^{*4} | - 0.75 to 0.75 ^{*4} incl. positioning errors | - 0.75 to 0.75 ^{*4} incl. positioning errors | - 0.75 to 0.75 ^{*4} incl. positioning errors |
| Linearity error | None | None | None |
| Influence of external current ^{*5} | ±0.2 ^{*5} | ±0.2 ^{*5} | ±0.2 ^{*5} |
| Weight | 192 g | 206 g | 222 g |

*1 In combination with Janitza measurement transducer RogoTrans up to 4000 A.

*2 On request, the frequency bandwidth and phase shifting model can be made available.

*3 With installation at a right angle to the phase conductor.

*4 Under consideration that the Janitza Rogowski current transformer is installed perpendicular to a primary conductor of min. Ø 15 mm.

*5 Under consideration that a further phase conductor of min. Ø 15 mm is installed at the same height and at a right angle to the Janitza Rogowski current transformer.

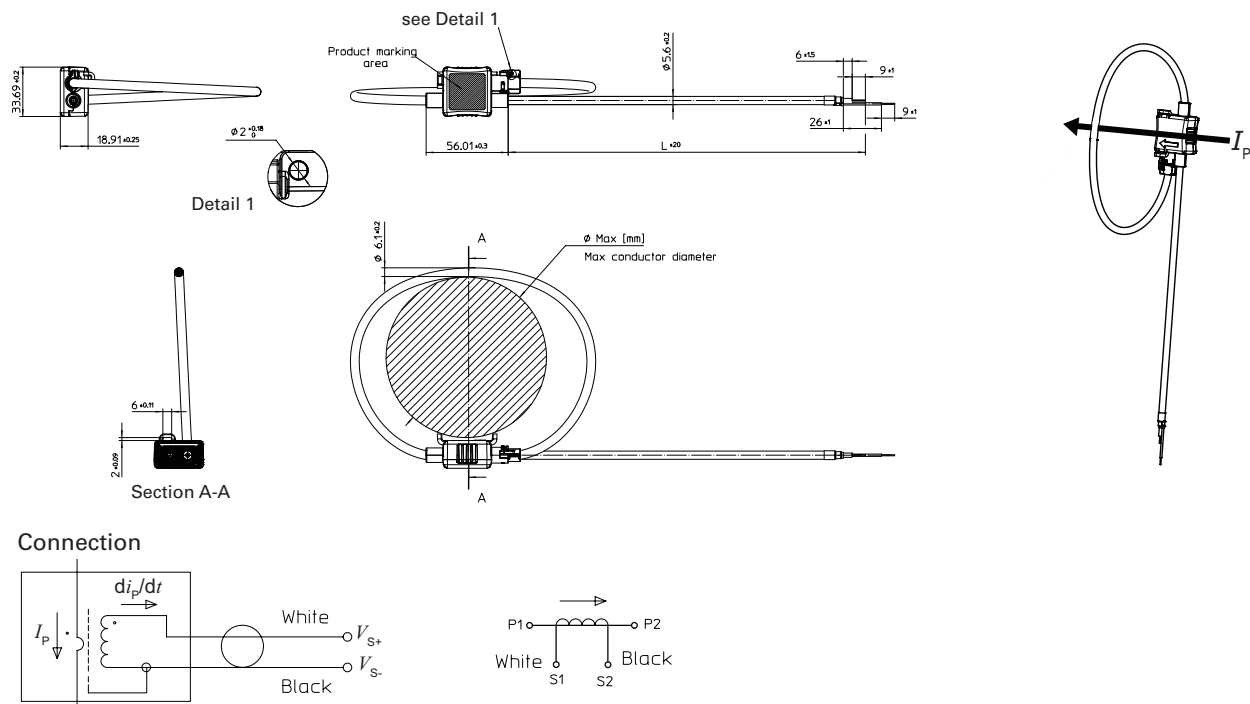

Rogowski current transformer and measurement transducer

Measurement transducer for Rogowski current transformer

The measurement transducer "RogoTrans" for the Rogowski current transformer records alternating currents or rather a voltage signal and possesses a standardised output signal of 0 to 1 A.

The metering range is up to 4000 A, the voltage supply is 24 V DC. The measurement transducer is very compact by design and can be mounted on a DIN rail.

- **Measurement transducer for Rogowski current transformer (item no. 15.03.609, 15.03.610, 15.03.611)**
- **Standardised output signal 0 to 1 A**
- **For measuring alternating currents**
- **Metering range up to 4000 A**
- **Voltage supply 24 V DC**
- **Compact construction in a plastic housing**
- **Assembly on DIN rail possible**

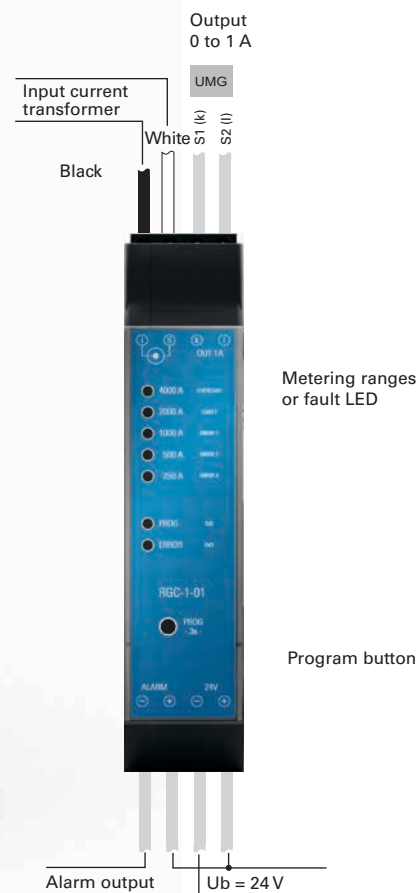

Rogowski current transformer and measurement transducer

Measurement transducer for Janitza Rogowski current transformer

Item no. 15.03.613

| | |
|--|---|
| Dimensions | 22.5 x 100 x 110 mm (W x H x D) |
| Weight | approx. 0.2 kg |
| Power supply | 24 V DC (18 to 36 V) / 1 A |
| Current draw | < 300 mA (with 1 A output current) < 80 mA (without output current) |
| Input | Janitza Rogowski coil max. 90 mV (4000 A range) |
| Current metering ranges | 1 to 4000 A 1 to 2000 A 1 to 1000 A 1 to 500 A 1 to 250 A |
| Metering range setting (button) LED (yellow) | Wear-free metering range selection via micro-controller and PGA |
| Operating and metering range display | via 6 LED (green) |
| Phase angle | < 1° |
| Linearity error at 50 Hz Measuring error at 50 Hz | < 0.2% in all metering ranges < 0.2% in all metering ranges |
| Input impedance | 10 k Ω in all metering ranges |
| Signal output | 0 to 1 A |
| Measurement range exceeding | 110% |
| Burden | 0 to 1.5 Ohm |
| Linearity error burden 0 to 1.5 Ohm | < 0.02% |
| Alarm output | 24 V DC / 200 mA (floating potential optical output, open with fault) |
| Alarm messages (via red LED) | Overload (range exceeding) Burden too great (output circuit) Undervoltage (24 V) |
| Alarm delay | 60 seconds |
| Protection type | IP30 |
| Ambient temperature | -20°C to 70°C |
| Installation position | Vertical; if multiple devices are used next to each other then a minimum distance of 5 mm must be maintained between the devices (heat development) |
| Storage temperature | -25°C to 85°C |

Example connection of Rogowski current transformer with measurement transducer on UMG 96RM

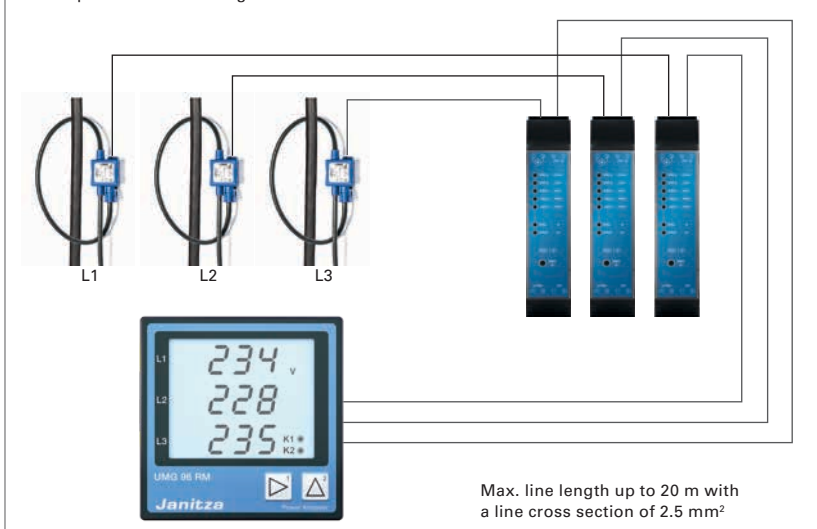

Janitza electronics GmbH
Vor dem Polstück 6 | 35633 Lahnau
Germany

Phone: +49 6441 9642-0
Fax: +49 6441 9642-30
info@janitza.de | www.janitza.com

Sales partner

Item no.: 33.03.768 • Doc. no.: 2.500.137.2 • Version 09/2018 • Subject to technical alterations.
The current version of the brochure is available at www.janitza.com