



GSE2FS-F5121

G2

MINIATURE PHOTOELECTRIC SENSORS

SICK
Sensor Intelligence.



Ordering information

| Type | Part no. |
|--------------|----------|
| GSE2FS-F5121 | 1095479 |

Other models and accessories → www.sick.com/G2

Illustration may differ



Detailed technical data

Features

| | |
|--|-----------------------------------|
| Functional principle | Through-beam photoelectric sensor |
| Dimensions (W x H x D) | 4.5 mm x 21 mm x 11 mm |
| Housing design (light emission) | Rectangular |
| Minimum detectable object (MDO) | 0.5 mm |
| Sensing range max. | 0 mm ... 200 mm |
| Sensing range | 0 mm ... 150 mm |
| Type of light | Visible red light |
| Light source | PinPoint LED ¹⁾ |
| Light spot size (distance) | Ø 15 mm (150 mm) |
| Wave length | 660 nm |
| Adjustment | None |

¹⁾ Average service life: 100,000 h at T_J = +25 °C.

Mechanics/electronics

| | |
|-------------------------------------|-----------------------------------|
| Supply voltage U_B | 10 V DC ... 30 V DC |
| Ripple | < 5 V _{pp} ¹⁾ |
| Current consumption | 20 mA ²⁾ |

¹⁾ May not exceed or fall below U_v tolerances.

²⁾ Without load.

³⁾ Signal transit time with resistive load.

⁴⁾ With light/dark ratio 1:1.

⁵⁾ Do not bend below 0 °C.

⁶⁾ A = V_S connections reverse-polarity protected.

⁷⁾ C = interference suppression.

⁸⁾ D = outputs overcurrent and short-circuit protected.

| | |
|---|---|
| Switching output | PNP |
| Switching mode | Dark switching |
| Output current I_{max.} | ≤ 50 mA |
| Response time | < 0.625 ms ³⁾ |
| Switching frequency | 800 Hz ⁴⁾ |
| Connection type | Cable with connector M8, 3-pin, 200 mm ⁵⁾ |
| Cable material | PVC |
| Cable diameter | Ø 2.3 mm |
| Circuit protection | A ⁶⁾ C ⁷⁾ D ⁸⁾ |
| Weight | 23 g |
| Housing material | Plastic, VISTAL® |
| Optics material | Plastic, MABS |
| Enclosure rating | IP67 |
| Ambient operating temperature | -20 °C ... +50 °C |
| Ambient temperature, storage | -40 °C ... +70 °C |
| UL File No. | NRKH.E348498 & NRKH7.E348498 |
| Repeatability (T_a not constant) | 0.1 mm |

1) May not exceed or fall below U_v tolerances.

2) Without load.

3) Signal transit time with resistive load.

4) With light/dark ratio 1:1.

5) Do not bend below 0 °C.

6) A = V_S connections reverse-polarity protected.

7) C = interference suppression.

8) D = outputs overcurrent and short-circuit protected.

Classifications

| | |
|---------------------|----------|
| ECLASS 5.0 | 27270901 |
| ECLASS 5.1.4 | 27270901 |
| ECLASS 6.0 | 27270901 |
| ECLASS 6.2 | 27270901 |
| ECLASS 7.0 | 27270901 |
| ECLASS 8.0 | 27270901 |
| ECLASS 8.1 | 27270901 |
| ECLASS 9.0 | 27270901 |
| ECLASS 10.0 | 27270901 |
| ECLASS 11.0 | 27270901 |
| ECLASS 12.0 | 27270901 |
| ETIM 5.0 | EC002716 |
| ETIM 6.0 | EC002716 |
| ETIM 7.0 | EC002716 |
| ETIM 8.0 | EC002716 |

UNSPSC 16.0901

39121528

Connection diagram

Cd-051

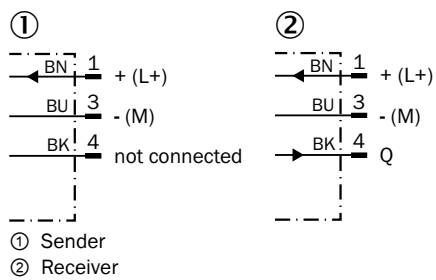

Characteristic curve

GSE2 Flat, GSE2 Flat Side, 150 mm

Operating reserve

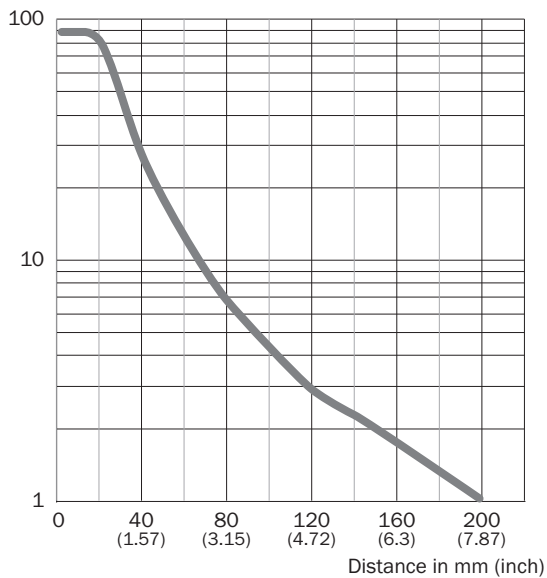

Light spot size

GSE2 Flat Side, 150 mm

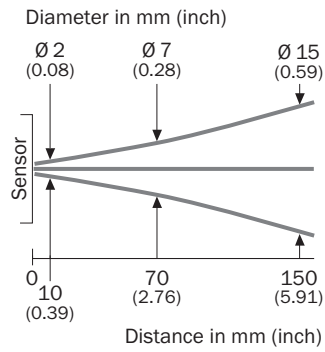

Sensing range diagram

GSE2 Flat, GSE2 Flat Side, 150 mm

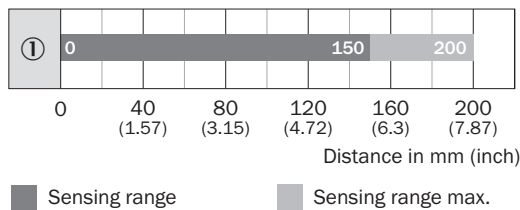

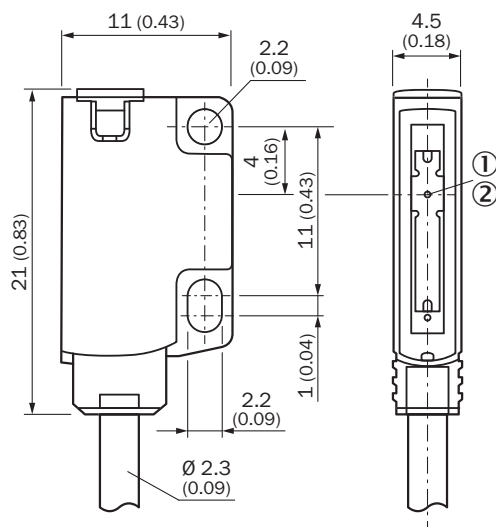

Dimensional drawing (Dimensions in mm (inch))



- ① Optical axis, receiver
- ② Optical axis, sender

Recommended accessories

Other models and accessories → www.sick.com/G2

| | Brief description | Type | Part no. |
|---|--|------------------------|----------|
| Mounting brackets and plates | | | |
|  | 10 pieces, Mounting plate for direct mounting, from the rear, on wall or machine, not adjustable. 10 Piece,Black ,Plastic, VISTAL®. Suitable for GSE2FS only | BEF-G2F-SIDE-SPACER-M2 | 2107264 |
| Plug connectors and cables | | | |
|  | <ul style="list-style-type: none"> • Connection type head A: Female connector, M8, 3-pin, straight, A-coded • Connection type head B: Flying leads • Signal type: Sensor/actuator cable • Cable: 5 m, 3-wire, PVC • Description: Sensor/actuator cable, unshielded • Application: Zones with chemicals | YF8U13-050VA1XLEAX | 2095884 |
|  | <ul style="list-style-type: none"> • Connection type head A: Male connector, M8, 3-pin, straight • Description: Unshielded • Connection systems: Screw-type terminals • Permitted cross-section: 0.14 mm² ... 0.5 mm² | STE-0803-G | 6037322 |

SICK AT A GLANCE

SICK is one of the leading manufacturers of intelligent sensors and sensor solutions for industrial applications. A unique range of products and services creates the perfect basis for controlling processes securely and efficiently, protecting individuals from accidents and preventing damage to the environment.

We have extensive experience in a wide range of industries and understand their processes and requirements. With intelligent sensors, we can deliver exactly what our customers need. In application centers in Europe, Asia and North America, system solutions are tested and optimized in accordance with customer specifications. All this makes us a reliable supplier and development partner.

Comprehensive services complete our offering: SICK LifeTime Services provide support throughout the machine life cycle and ensure safety and productivity.

For us, that is “Sensor Intelligence.”

WORLDWIDE PRESENCE:

Contacts and other locations –www.sick.com