

# WTT12LC-B2553

PowerProx

MULTITASK PHOTOELECTRIC SENSORS

**SICK**  
Sensor Intelligence.

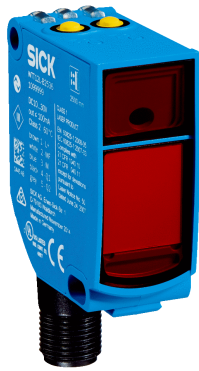

Illustration may differ



### Ordering information

Type	Part no.
WTT12LC-B2553	1082412

Other models and accessories → [www.sick.com/PowerProx](http://www.sick.com/PowerProx)

### Detailed technical data

#### Features

<b>Functional principle</b>	Photoelectric proximity sensor
<b>Functional principle detail</b>	Background suppression, Optical time-of-flight
<b>Dimensions (W x H x D)</b>	20 mm x 49.6 mm x 44.2 mm
<b>Housing design (light emission)</b>	Rectangular
<b>Sensing range max.</b>	50 mm ... 1,800 mm <sup>1)</sup>
<b>Sensing range</b>	100 mm ... 1,800 mm <sup>1) 2)</sup>
<b>Distance value</b>	
Measuring range	50 mm ... 1,800 mm <sup>1)</sup>
Resolution	1 mm
Repeatability	1,2 mm ... 3,0 mm <sup>3) 4) 5)</sup>
Accuracy	Typ. ± 20 mm, typ. ± 15 mm <sup>6) 7)</sup>
<b>Type of light</b>	Visible red light
<b>Light source</b>	Laser <sup>8)</sup>
<b>Light spot size (distance)</b>	Ø 12 mm (1,800 mm)
<b>Wave length</b>	658 nm

<sup>1)</sup> Object with 6 ... 90% remission (based on standard white, DIN 5033).

<sup>2)</sup> Adjustable.

<sup>3)</sup> Equivalent to 1  $\sigma$ .

<sup>4)</sup> See characteristic curves repeatability.

<sup>5)</sup> 6% ... 90% remission factor.

<sup>6)</sup> 50 ... 1000 mm.

<sup>7)</sup> 1000 ... 1800 mm.

<sup>8)</sup> Average service life: 100,000 h at T<sub>J</sub> = +25 °C.

<b>Laser class</b>	1 (IEC 60825-1 / CDRH 21 CFR 1040.10 & 1040.11)
<b>Adjustment</b>	Single teach-in button (2 x) IO-Link

<sup>1)</sup> Object with 6 ... 90% remission (based on standard white, DIN 5033).

<sup>2)</sup> Adjustable.

<sup>3)</sup> Equivalent to 1  $\sigma$ .

<sup>4)</sup> See characteristic curves repeatability.

<sup>5)</sup> 6% ... 90% remission factor.

<sup>6)</sup> 50 ... 1000 mm.

<sup>7)</sup> 1000 ... 1800 mm.

<sup>8)</sup> Average service life: 100,000 h at  $T_U = +25 \text{ }^\circ\text{C}$ .

## Mechanics/electronics

<b>Supply voltage <math>U_B</math></b>	10 V DC ... 30 V DC <sup>1) 2)</sup>
<b>Ripple</b>	< 5 V <sub>pp</sub> <sup>3)</sup>
<b>Current consumption</b>	70 mA <sup>4)</sup>
<b>Switching output</b>	Push-pull: PNP/NPN <sup>5)</sup>
<b>Number of switching outputs</b>	2 (Q <sub>1</sub> , Q <sub>2</sub> ) <sup>5)</sup>
<b>Switching mode</b>	Light switching <sup>5)</sup>
<b>Output current <math>I_{\max}</math></b>	≤ 100 mA
<b>Response time</b>	≤ 5 ms <sup>6)</sup>
<b>Switching frequency</b>	100 Hz <sup>7)</sup>
<b>Analog output</b>	-
<b>Input</b>	MF <sub>in</sub> = multifunctional input programmable
<b>Connection type</b>	Male connector M12, 5-pin
<b>Circuit protection</b>	A <sup>8)</sup> B <sup>9)</sup> C <sup>10)</sup>
<b>Protection class</b>	III
<b>Weight</b>	48 g
<b>Housing material</b>	Plastic, VISTAL®
<b>Optics material</b>	Plastic, PMMA
<b>Enclosure rating</b>	IP67
<b>Ambient operating temperature</b>	-35 °C ... +50 °C <sup>11)</sup>

<sup>1)</sup> Limit values. Operated in short-circuit protected network: max. 8 A.

<sup>2)</sup>  $V_S$  min at IO-Link operation = 18 V.

<sup>3)</sup> May not exceed or fall below  $U_V$  tolerances.

<sup>4)</sup> Without load. At  $V_S = 24$  V.

<sup>5)</sup> Q<sub>1</sub>, Q<sub>2</sub> = 2 switching thresholds, light switching.

<sup>6)</sup> Signal transit time with resistive load.

<sup>7)</sup> With light/dark ratio 1:1.

<sup>8)</sup> A =  $V_S$  connections reverse-polarity protected.

<sup>9)</sup> B = inputs and output reverse-polarity protected.

<sup>10)</sup> C = interference suppression.

<sup>11)</sup> As of  $T_a = 45 \text{ }^\circ\text{C}$ , a max.load current  $I_{\max} = 50$  mA is permitted.

<sup>12)</sup> Below  $T_U = -10 \text{ }^\circ\text{C}$  a warm-up time is necessary.

<b>Ambient temperature, storage</b>	-40 °C ... +70 °C
<b>Warm-up time</b>	< 15 min <sup>12)</sup>
<b>Initialization time</b>	< 300 ms
<b>UL File No.</b>	NRKH.E181493

1) Limit values. Operated in short-circuit protected network: max. 8 A.

2)  $V_S$  min at IO-Link operation = 18 V.

3) May not exceed or fall below  $U_V$  tolerances.

4) Without load. At  $V_S = 24$  V.

5) Q1, Q2 = 2 switching thresholds, light switching.

6) Signal transit time with resistive load.

7) With light/dark ratio 1:1.

8) A =  $V_S$  connections reverse-polarity protected.

9) B = inputs and output reverse-polarity protected.

10) C = interference suppression.

11) As of  $T_a = 45$  °C, a max.load current  $I_{max} = 50$  mA is permitted.

12) Below  $T_U = -10$  °C a warm-up time is necessary.

### Safety-related parameters

<b>MTTF<sub>D</sub></b>	138 years
<b>DC<sub>avg</sub></b>	0 %
<b>T<sub>M</sub> (mission time)</b>	20 years

### Communication interface

<b>Communication interface</b>	IO-Link V1.1
<b>Communication Interface detail</b>	COM2 (38,4 kBaud)
<b>Cycle time</b>	5 ms
<b>Process data length</b>	32 Bit
<b>Process data structure</b>	Bit 0 = switching signal Q <sub>01</sub> Bit 1 = switching signal Q <sub>02</sub> Bit 2 ... 8 = BDC 2 ... 8 Bit 9 ... 15 = empty Bit 16 ... 31 = distance value
<b>Additional features</b>	8 switching points for distance to object, of which 2 can be inverted, 1 switching point as switching window or configurable with hysteresis., multifunctional input: sender off, external teach, inactive
<b>VendorID</b>	26
<b>DeviceID HEX</b>	0x800147
<b>DeviceID DEC</b>	8388935

### Classifications

<b>eCl@ss 5.0</b>	27270904
<b>eCl@ss 5.1.4</b>	27270904
<b>eCl@ss 6.0</b>	27270904
<b>eCl@ss 6.2</b>	27270904
<b>eCl@ss 7.0</b>	27270904
<b>eCl@ss 8.0</b>	27270904
<b>eCl@ss 8.1</b>	27270904
<b>eCl@ss 9.0</b>	27270904

<b>eCl@ss 10.0</b>	27270904
<b>eCl@ss 11.0</b>	27270904
<b>eCl@ss 12.0</b>	27270903
<b>ETIM 5.0</b>	EC002719
<b>ETIM 6.0</b>	EC002719
<b>ETIM 7.0</b>	EC002719
<b>ETIM 8.0</b>	EC002719
<b>UNSPSC 16.0901</b>	39121528

**Dimensional drawing** (Dimensions in mm (inch))

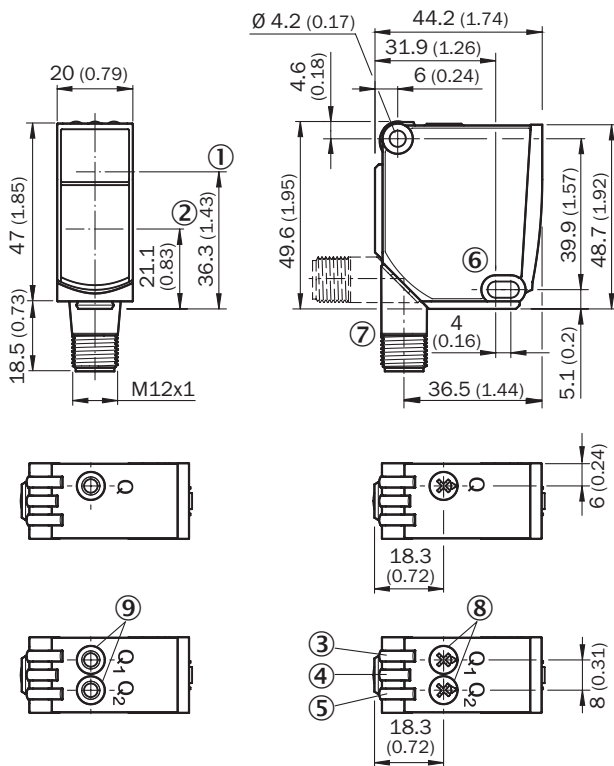

- ① Optical axis, sender
- ② Optical axis, receiver
- ③ LED indicator yellow: Status of received light beam
- ④ LED indicator green: power on
- ⑤ LED indicator yellow: Status of received light beam
- ⑥ Mounting hole,  $\varnothing 4.2$  mm
- ⑦ Connection
- ⑧ Potentiometer
- ⑨ Single teach-in button

### Connection diagram

Cd-290

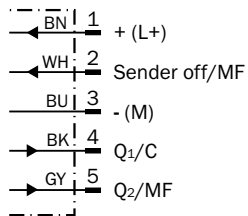

### Characteristic curve

Min. distance from object to background in mm (inch)

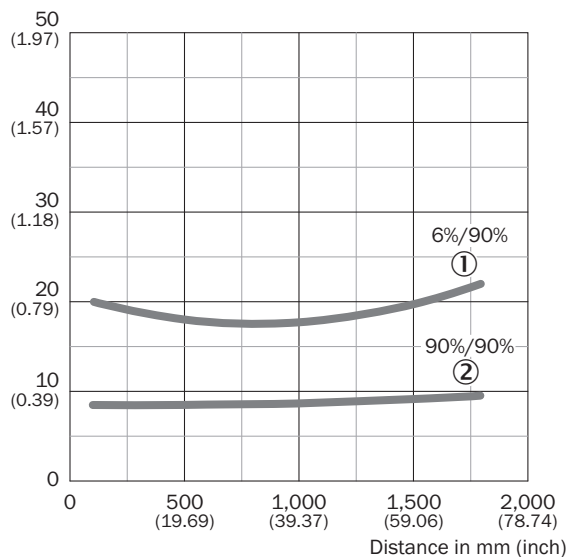

- ① Sensing range on black, 6% remission factor
- ② Sensing range on white, 90% remission factor

### Light spot size

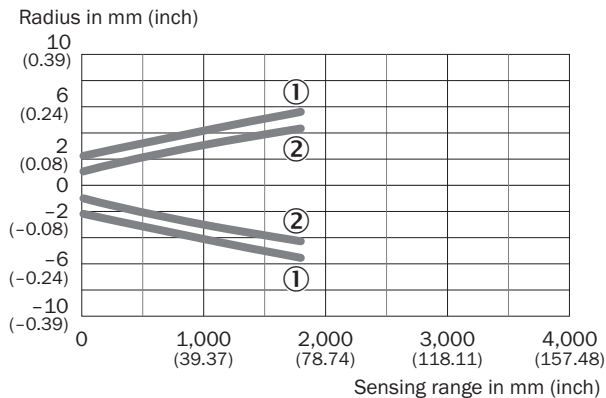

- ① Light spot horizontal
- ② Light spot vertical

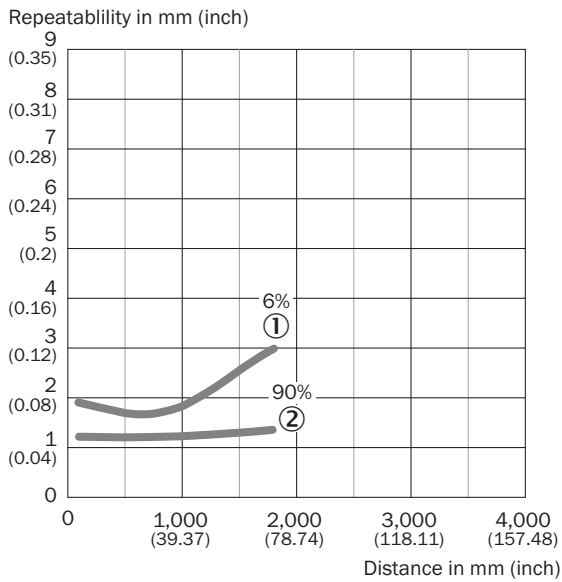

## Repeatability



- ① 6 % remission, on black
- ② 90 % remission, on white

## Recommended accessories

Other models and accessories → [www.sick.com/PowerProx](http://www.sick.com/PowerProx)

	Brief description	Type	Part no.
<b>Plug connectors and cables</b>			
	Head A: female connector, M12, 5-pin, straight, A-coded Head B: Flying leads Cable: Sensor/actuator cable, PVC, unshielded, 5 m	YF2A15-050VB5XLEAX	2096240
	Head A: male connector, M12, 5-pin, straight Cable: unshielded For field bus technology	STE-1205-G	6022083

## Recommended services

Additional services → [www.sick.com/PowerProx](http://www.sick.com/PowerProx)

	Type	Part no.
<b>Function Block Factory</b>		
<ul style="list-style-type: none"> <li>• <b>Description:</b> The Function Block Factory supports common programmable logic controllers (PLCs) from various manufacturers, such as Siemens, Beckhoff, Rockwell Automation and B&amp;R. More information on the FBF can be found <a _blank"="" href="https://fbf.cloud.sick.com target=">here</a>.</li> <li>• <b>Note:</b> You can configure your function block at <a _blank"="" href="https://fbf.cloud.sick.com target=">Function Block Factory</a>. As a login please use your SICK ID.</li> </ul>	Function Block Factory	On request

## SICK AT A GLANCE

SICK is one of the leading manufacturers of intelligent sensors and sensor solutions for industrial applications. A unique range of products and services creates the perfect basis for controlling processes securely and efficiently, protecting individuals from accidents and preventing damage to the environment.

We have extensive experience in a wide range of industries and understand their processes and requirements. With intelligent sensors, we can deliver exactly what our customers need. In application centers in Europe, Asia and North America, system solutions are tested and optimized in accordance with customer specifications. All this makes us a reliable supplier and development partner.

Comprehensive services complete our offering: SICK LifeTime Services provide support throughout the machine life cycle and ensure safety and productivity.

For us, that is “Sensor Intelligence.”

## WORLDWIDE PRESENCE:

Contacts and other locations –[www.sick.com](http://www.sick.com)