

Operating Guide

VZL 2, VZL 3, VZL 4 DN 15-20

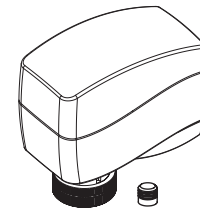

MAINTENANCE
FREE

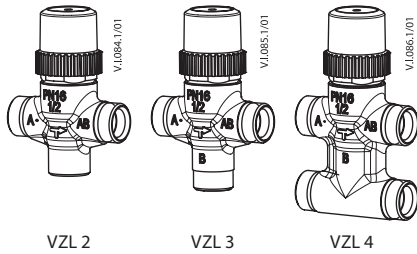

AMV(E) 130, 140

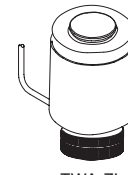

TWA-ZL

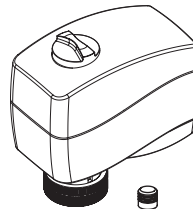
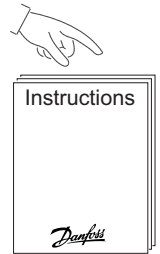

AMV(E) 130H, 140H

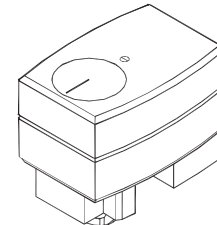

AMV(E) 13 (SU)

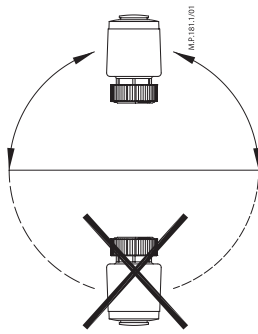

IP 41
TWA-ZL

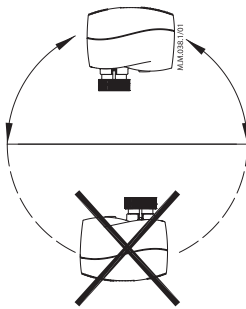

IP 42
AMV(E) 130/140

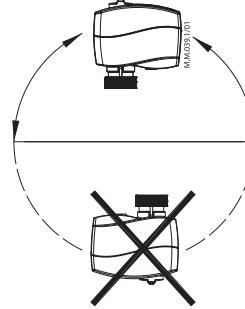

IP 42
AMV(E) 130H/140H

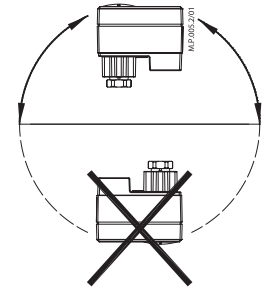

IP 54
AMV(E) 13 (SU)

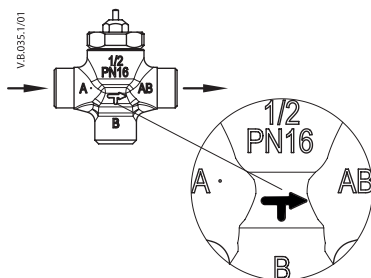
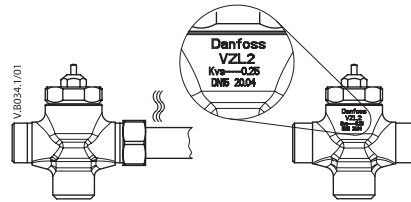

VZL 2, VZL 3, VZL 4

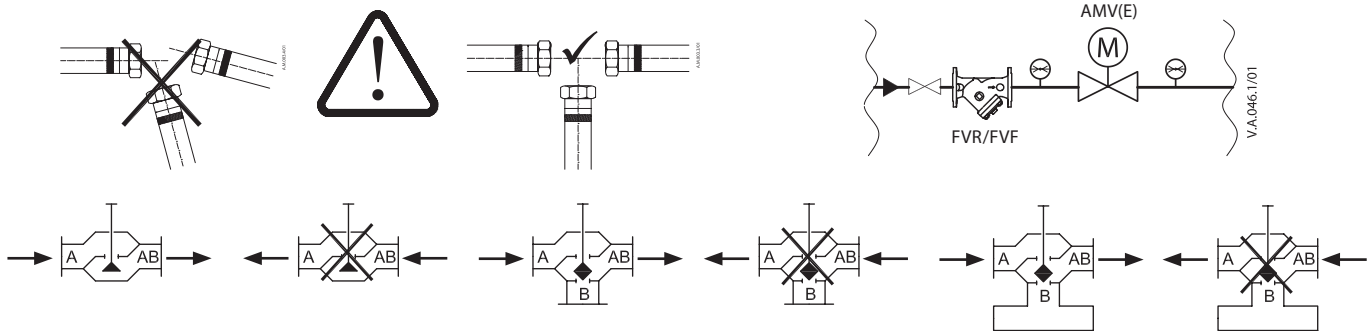
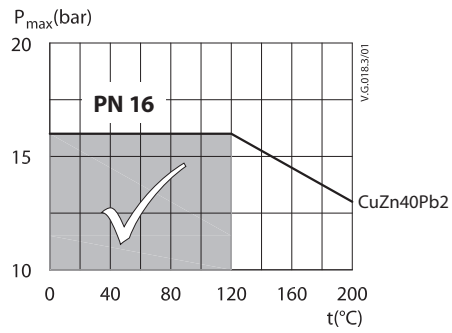
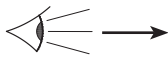

TWA-ZL + VZL

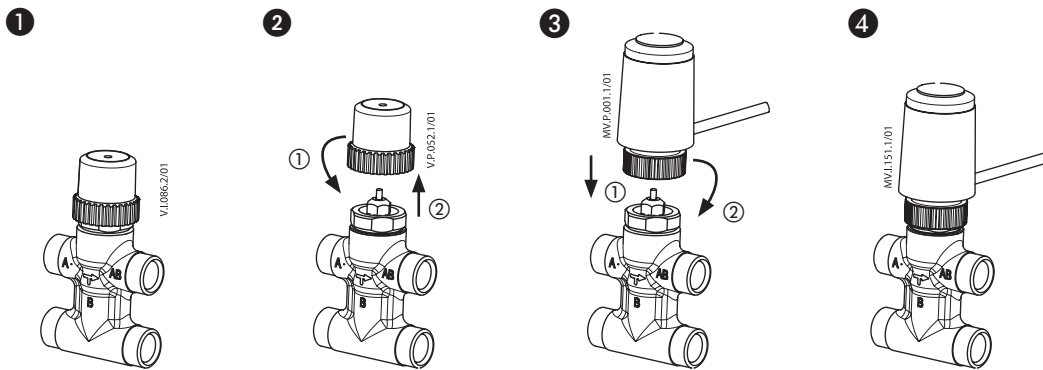

AMV(E) 130(H), 140(H) + VZL

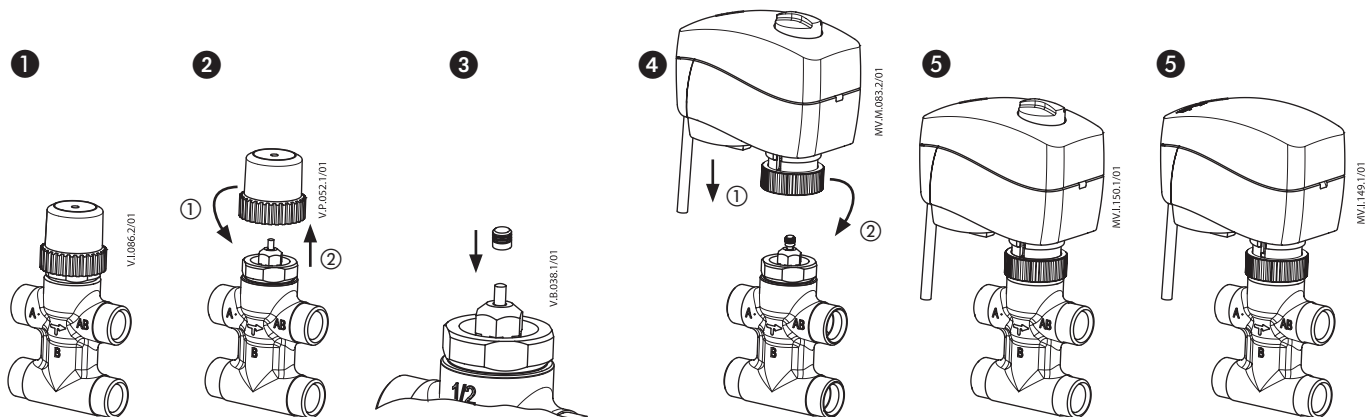

VZL 2, VZL 3, VZL 4

AMV(E) 13 SU + VZL

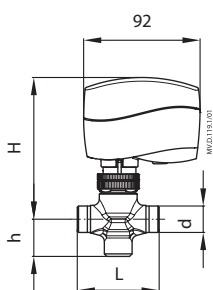
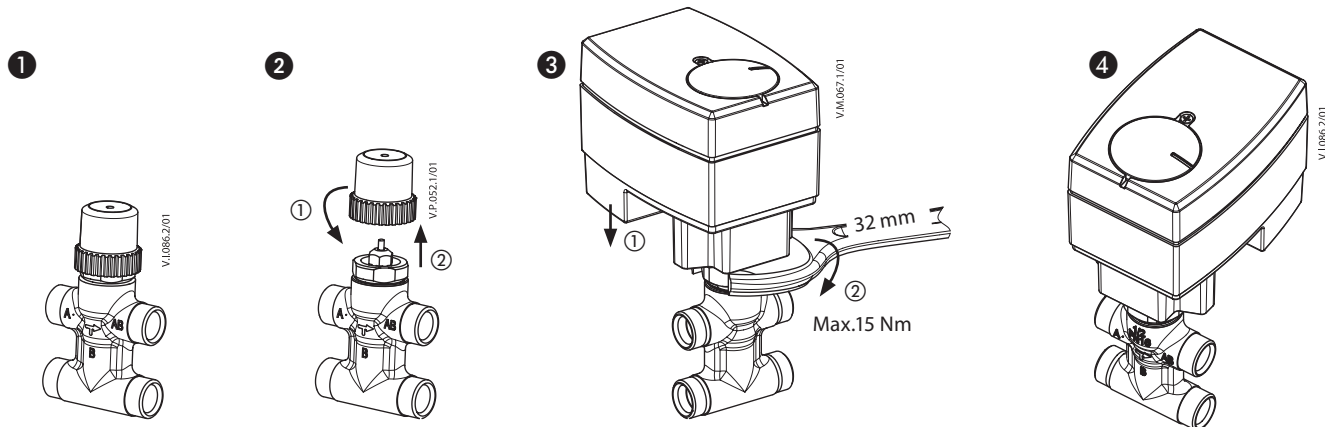

AMV(E) 130/140 + VZL 2

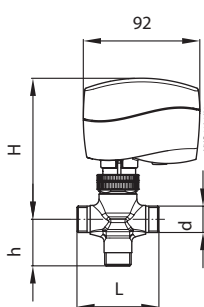

AMV(E) 130/140 + VZL 3

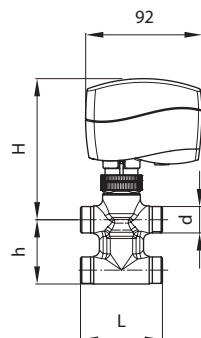

AMV(E) 130/140 + VZL 4

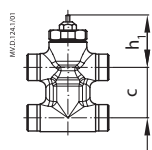

VZL valve

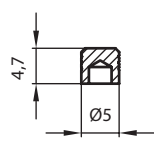

Stem extension plug

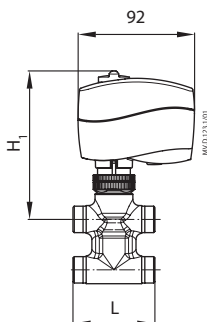

AMV(E) 130H/140H + VZL

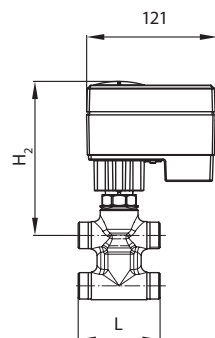

AMV(E) 13 SU + VZL

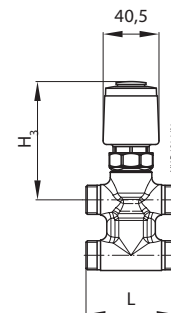

TWA-ZL + VZL

Type	d	L	H	H ₁	H ₂	H ₃	c	h	h ₁
		mm							
VZL 2 DN 15	G 1/2"	65	111	117	140	88	-	29,5	47,5
VZL 2 DN 20 ¹⁾	G 3/4"	77	117	123	146	94		34,0	
VZL 3 DN 15	G 1/2"	65	111	117	140	88		35,0	
VZL 3 DN 20 ¹⁾	G 3/4"	77	117	123	146	94		35,0	
VZL 4 DN 15	G 1/2"	65	111	117	140	88	40	51,0	
VZL 4 DN 20 ¹⁾	G 3/4"	77	117	123	146	94	50	65,0	

¹⁾ conex valves DN 20 - G 1 1/8" 14 TPI

G	Ød (mm)	L (mm)
1/2"	12	15
3/4"	15	20

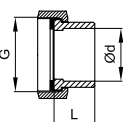

G	R (")	L (mm)
1/2"	3/8	23
3/4"	1/2	26

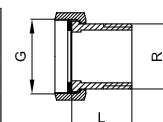



VZL 2, VZL 3, VZL 4
