

I (A)	160	250	400	630	800
Réf.	265 00	265 01	265 02	265 03	265 04
L max (mm)	450	450	450	500	600

1

160-250-400 A

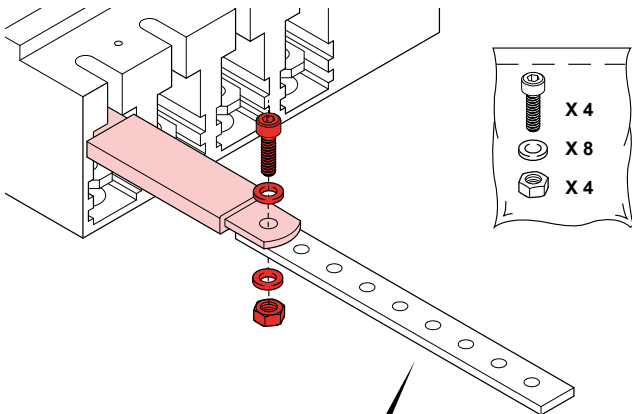

160 A	18 x 4 mm
250 A	25 x 5 mm
400 A	32 x 5 mm

630 A

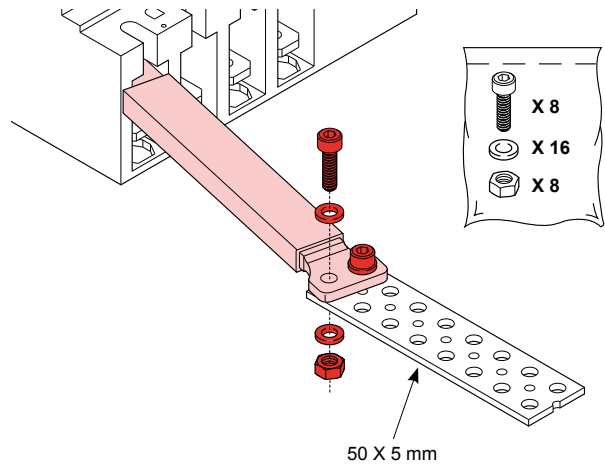

800 A

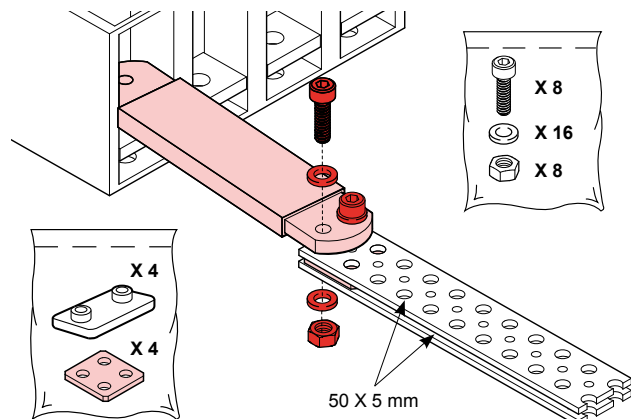

2

160-250-400-630 A

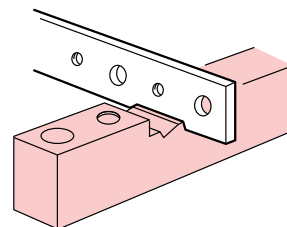
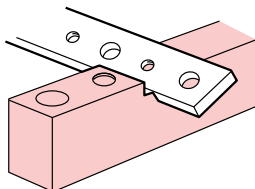
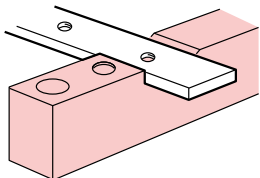

800 A

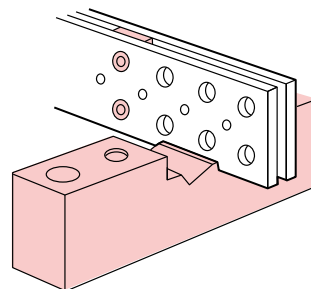
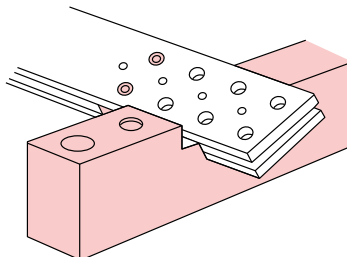
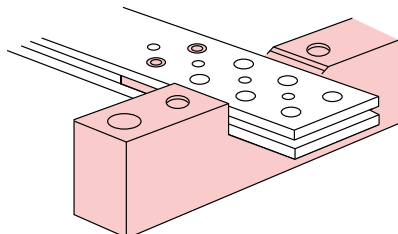
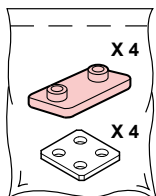

3

160-250 A

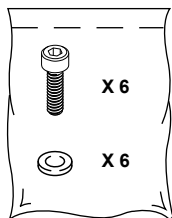
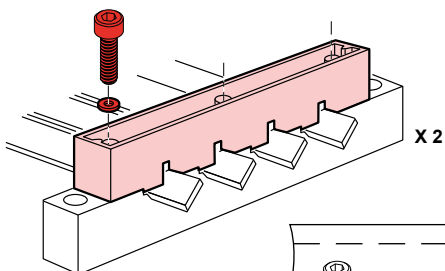

400-630-800 A

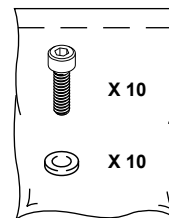
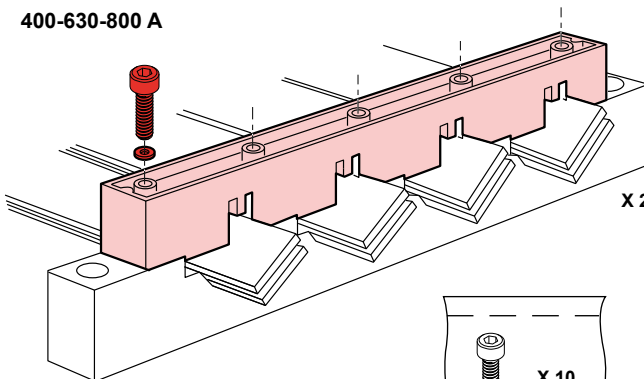

160-250-400-630-800 A

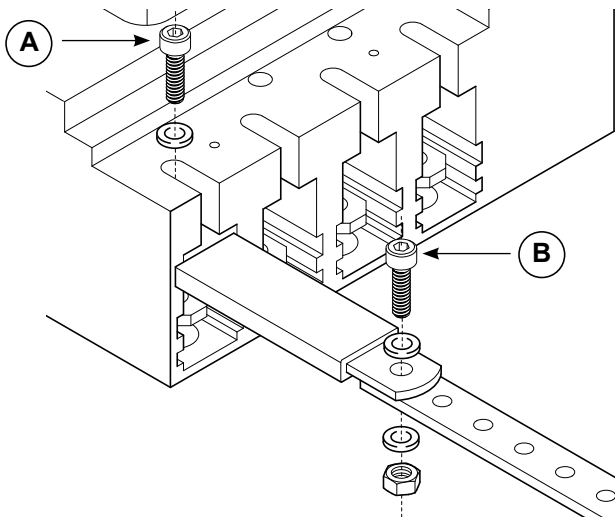

I (A)	160	250	400	630	800
(A)	10Nm	10Nm	24Nm	24Nm	25Nm
(B)	10/15 Nm	15/20Nm	40/50 Nm	40/50 Nm	40/50 Nm