



V2D652R-MCXXF6 for Systems

Lector64x/Lector65x

IMAGE-BASED CODE READERS

SICK
Sensor Intelligence.



Ordering information

| Type | Part no. |
|----------------------------|----------|
| V2D652R-MCXXF6 for Systems | 1071728 |

Other models and accessories → www.sick.com/Lector64x_Lector65x



Detailed technical data

Features

| | |
|---------------------------|---|
| Variant | Main unit |
| Optical focus | Adjustable focus (manually) |
| Sensor | CMOS matrix sensor, grayscale values |
| Sensor resolution | 2,048 px x 1,088 px |
| Illumination | To be ordered separately as accessories |
| Alignment aid | Laser, Red, 630 nm ... 680 nm |
| Laser class | 1, complies with 21 CFR 1040.10 except for the conformance according to "Laser Notice No. 50" from June 24, 2007 (IEC 60825-1:2014, EN 60825-1:2014+A11:2021) |
| Lens | C-mount |
| | Optical format 1" |
| | Note To be ordered separately as accessories |
| Reading distance | 300 mm ... 2,200 mm ¹⁾ |
| Scanning frequency | 70 Hz, With resolution of 2 megapixels |
| Code resolution | ≥ 0.1 mm ²⁾ |

¹⁾ Depends on lens used, for details see field of view diagram.

²⁾ Depends on lens used.

Mechanics/electronics

| | |
|------------------------|--|
| Connection type | 1 x M12, 5-pin plug (CAN) 1 x M12, 5-pin female connector (CAN) 1 x M8, 3-pin socket (external illumination) 2 x M12, 8-pin socket (Ethernet, P1 not yet with function) |
|------------------------|--|

¹⁾ Housing only, without lens and optics protection hood.

| | |
|-------------------------------|--|
| Supply voltage | 24 V DC, ± 20 % |
| Power consumption | Typ. 20 W, ± 20 % |
| Output current | ≤ 100 mA |
| Housing | Aluminum die cast |
| Housing color | Light blue (RAL 5012) |
| Window material | Plastic (To be ordered separately as accessories) Glass (To be ordered separately as accessories) |
| Enclosure rating | IP65 (EN 60529 (1991-10), EN 60529/A2 (2002-02)) |
| Protection class | III |
| Electrical safety | EN 60950-1 (2011-01) |
| Weight | 635 g |
| Dimensions (L x W x H) | 142 mm x 89 mm x 46 mm ¹⁾ |
| MTBF | 100,000 h |

¹⁾ Housing only, without lens and optics protection hood.

Performance

| | |
|---------------------------------|---|
| Readable code structures | 1D codes, Stacked, 2D codes |
| Bar code types | GS1-128 / EAN 128, UPC / GTIN / EAN, Interleaved 2 of 5, Pharmacode, GS1 DataBar, Code 39, Code 128, Codabar, Code 32, Code 93, USPS (Postnet, Planet, USPS4SCB), Australian Post, Dutch KIX Post, Royal Mail, Swedish Post |
| 2D code types | Data Matrix ECC200, GS1 Data-Matrix, MaxiCode, QR code |
| Stacked code types | PDF417 |
| Code qualification | On the basis of ISO/IEC 16022, ISO/IEC 15415, ISO/IEC 18004 |
| Internal image storage | 512 MB |

Interfaces

| | |
|-----------------------------|---|
| Ethernet | ✓, TCP/IP |
| Function | Data interface (read result output), Service interface, FTP (image transmission) |
| Data transmission rate | 10/100/1,000 Mbit/s |
| EtherNet/IP™ | ✓ |
| Data transmission rate | 10/100/1,000 Mbit/s |
| CAN | ✓ |
| Function | SICK CAN sensor network CSN (CAN controller/CAN device, multiplexer/server) |
| Data transmission rate | 20 kbit/s ... 1 Mbit/s |
| Digital inputs | 4 ("Sensor 1", "Sensor 2", 2 inputs via optional CMC600 parameter memory in CDB650/CDM420) |
| Configurable inputs | Encoder input, external trigger |
| Digital outputs | 6 (CDB650: "Result 1", "Result 2", "Result 3", "Result 4", 2 external outputs via CMC600 or CDM420: "Result 1", "Result 2", 2 external outputs via CMC600 or cable with open end: "Result 1", "Result 2", "Result 3", "Result 4") |
| Configurable outputs | Good read, External illumination control, free configurable output condition, "device ready" |
| Reading pulse | Digital inputs, non-powered, serial interface, Ethernet, CAN, auto pulse, presentation mode |
| Optical indicators | 21 LEDs (10 x status display, 10 x LED bar graph, 1 green feedback spot) |
| Acoustic indicators | Beeper/buzzer (can be switched off, can be assigned a function to signal a result) |
| Control elements | 2 buttons (choose and start/stop functions) |

| | |
|--------------------------------------|--|
| Operator interfaces | Web server |
| Configuration software | SOPAS ET |
| Memory card | Micro SD memory card (flash card) max. 16 GB, optional |
| Data storage and retrieval | Image and data storage via microSD memory card and external FTP |
| Maximum encoder frequency | 1 kHz |
| External illumination control | Via digital output (max. 24 V trigger) or external illumination connection |

Ambient data

| | |
|--|---|
| Electromagnetic compatibility (EMC) | EN 61000-6-2:2005-08 / EN 61000-6-3 (2007-01) |
| Vibration resistance | EN 60068-2-6:2008-02 |
| Shock resistance | EN 60068-2-6 |
| Ambient operating temperature | 0 °C ... +50 °C |
| Storage temperature | -20 °C ... +70 °C |
| Permissible relative humidity | 90 %, Non-condensing |
| Ambient light immunity | 2,000 lx, on code |

Classifications

| | |
|-----------------------|----------|
| ECLASS 5.0 | 27280103 |
| ECLASS 5.1.4 | 27280103 |
| ECLASS 6.0 | 27280103 |
| ECLASS 6.2 | 27280103 |
| ECLASS 7.0 | 27280103 |
| ECLASS 8.0 | 27280103 |
| ECLASS 8.1 | 27280103 |
| ECLASS 9.0 | 27280103 |
| ECLASS 10.0 | 27280103 |
| ECLASS 11.0 | 27280103 |
| ECLASS 12.0 | 27280103 |
| ETIM 5.0 | EC002550 |
| ETIM 6.0 | EC002550 |
| ETIM 7.0 | EC002999 |
| ETIM 8.0 | EC002999 |
| UNSPSC 16.0901 | 43211701 |

Dimensional drawing (Dimensions in mm (inch))

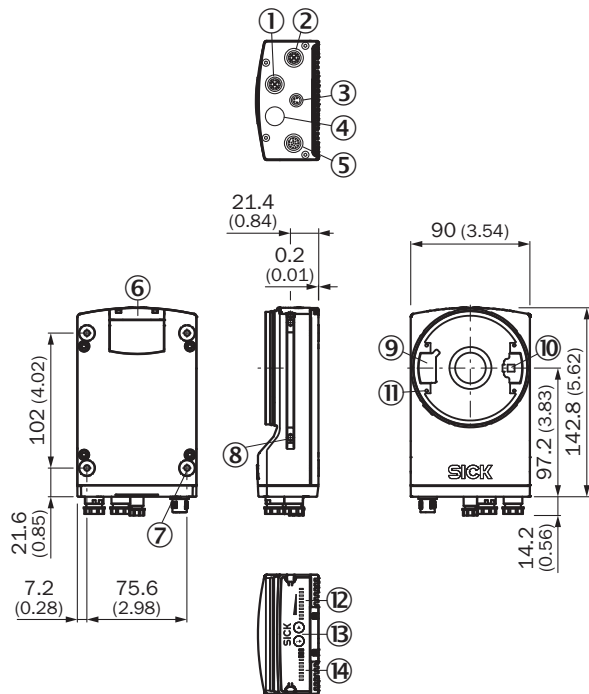

- ① "Ethernet" P1 connection
- ② P3 connection "Ethernet"
- ③ X2 "USB" connection or "trigger external lighting", depending on type
- ④ P2 connection "CAN OUT", depending on type
- ⑤ X1 "Power/Serial Data/CAN/I/O" connection or "CAN IN", depending on type
- ⑥ Cover for the microSD memory card
- ⑦ M5 blind tapped holes, 5 mm deep (4 x), for mounting the sensor
- ⑧ Sliding nut M5, 5.5 mm deep (2 x), for mounting (as alternative)
- ⑨ Plug connector for connecting the integrated lighting
- ⑩ Laser alignment aid exit
- ⑪ 2.5 mm blind tapped holes (4 x) for mounting the spacers for the integrable illumination
- ⑫ Bar graph display
- ⑬ Function button (2 x)
- ⑭ LED for status display (2 levels), 10 x

Field of view

Perceived area of field of view: H x V (mm) ①

| V2D654R | V2D652R |
|---------------|-------------|
| 1,000 x 1,000 | 1,000 x 500 |
| 900 x 900 | 900 x 450 |
| 800 x 800 | 800 x 400 |
| 700 x 700 | 700 x 350 |
| 600 x 600 | 600 x 300 |
| 500 x 500 | 500 x 250 |
| 400 x 400 | 400 x 200 |
| 300 x 300 | 300 x 150 |
| 200 x 200 | 200 x 100 |
| 100 x 100 | 100 x 50 |
| 0 | 0 |

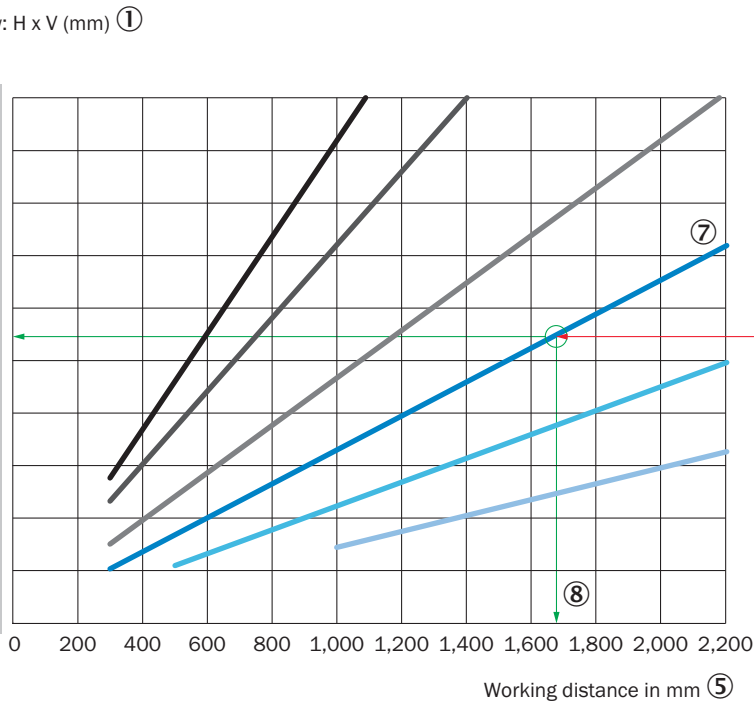

Min. resolution in mm ②

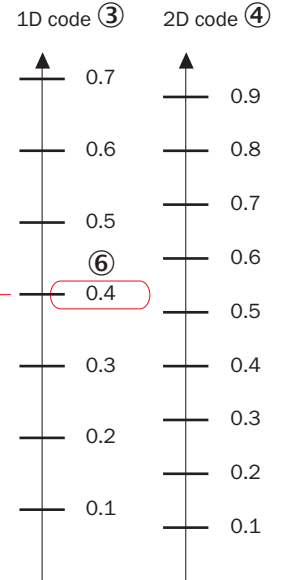

- f = 12 mm
- f = 25 mm
- f = 50 mm
- f = 16 mm
- f = 35 mm
- f = 75 mm

- ① Perceived field of view area: horizontal x vertical (mm)
- ② Minimum resolution in mm
- ③ 1D code
- ④ 2D code
- ⑤ Working distance in mm
- ⑥ Selected code resolution
- ⑦ Focal length of lens, here example for f = 35.0 mm
- ⑧ Reading off: resultant maximum working distance
- ⑨ Reading off: Resulting perceived area of the field of view V2D652R (mm x mm)
- ⑩ Reading off: Resulting perceived area of the field of view V2D654R (mm x mm)

Field of view, Lector65x Flex with Panorama 35 mm/40 mm

Dimensions in mm (inch/*mil)

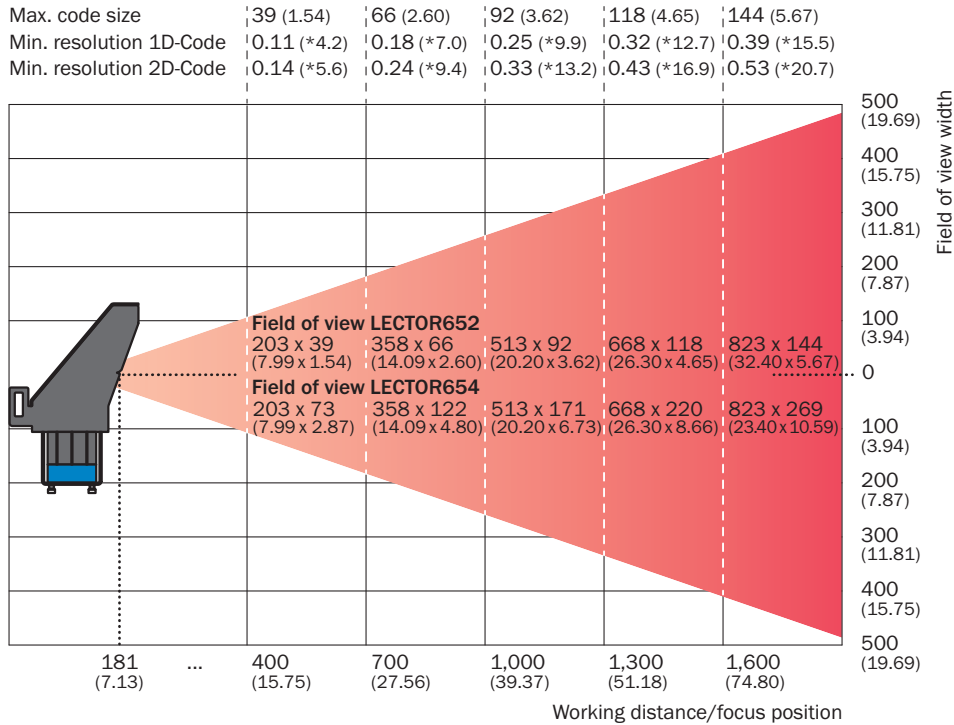

Field of view Lector65x with Panorama 25 mm

Dimensions in mm (inch/*mil)

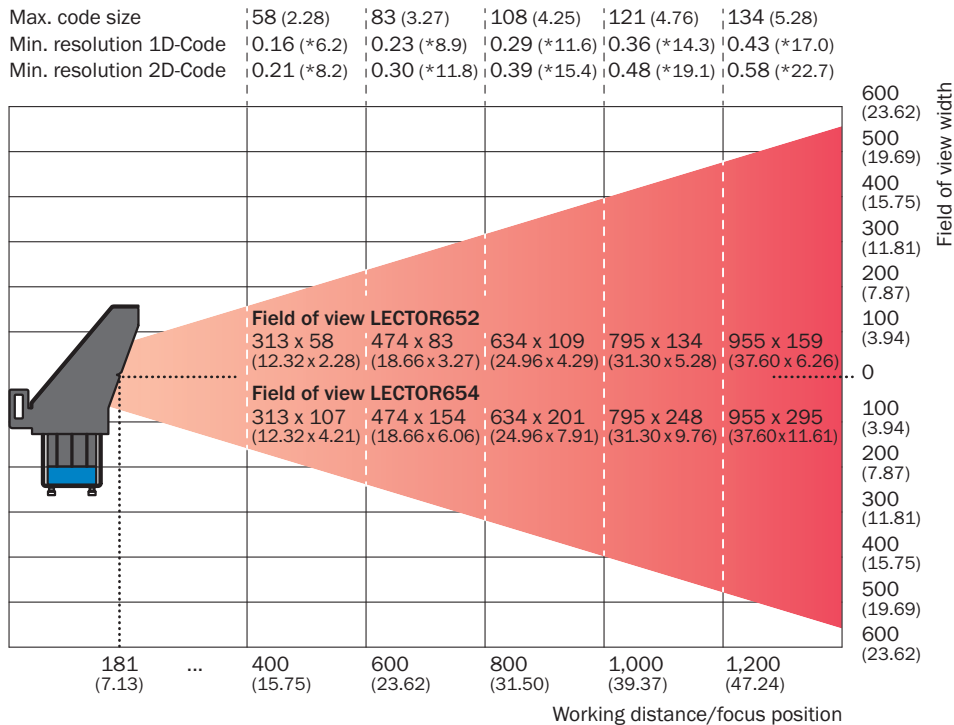

Field of view, Lector65x Flex with Panorama 50 mm

Dimensions in mm (inch/*mil)

| | | | | | |
|-------------------------|-------------|-------------|--------------|--------------|--------------|
| Max. code size | 72 (2.83) | 105 (4.13) | 133 (5.24) | 162 (6.38) | 190 (7.48) |
| Min. resolution 1D-Code | 0.11 (*4.1) | 0.16 (*6.1) | 0.20 (*8.1) | 0.25 (*10.0) | 0.30 (*12.0) |
| Min. resolution 2D-Code | 0.14 (*5.5) | 0.21 (*8.2) | 0.27 (*10.8) | 0.34 (*13.4) | 0.41 (*16.0) |

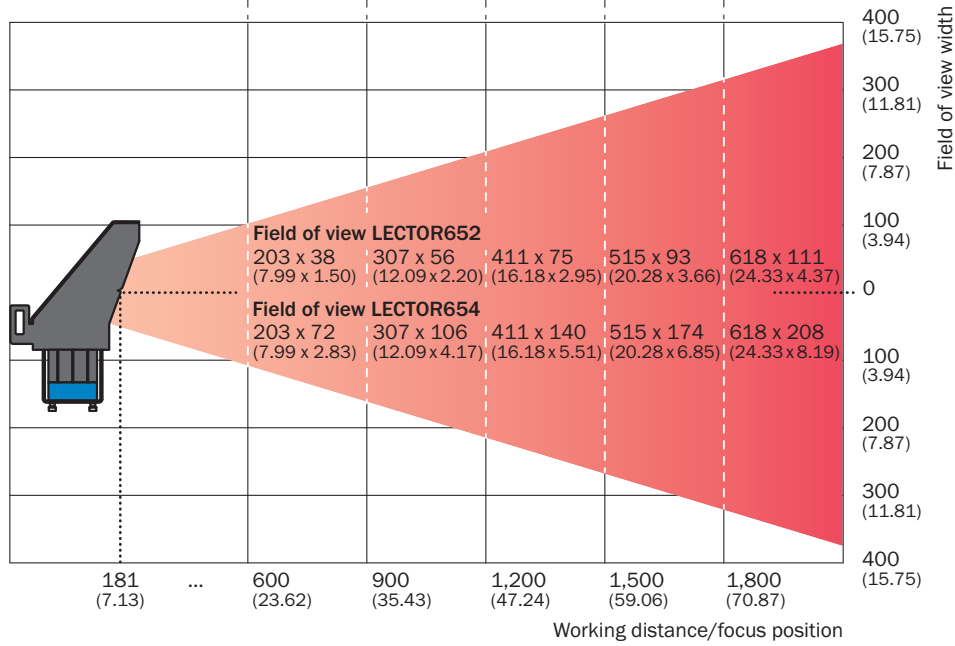

Selection Guide

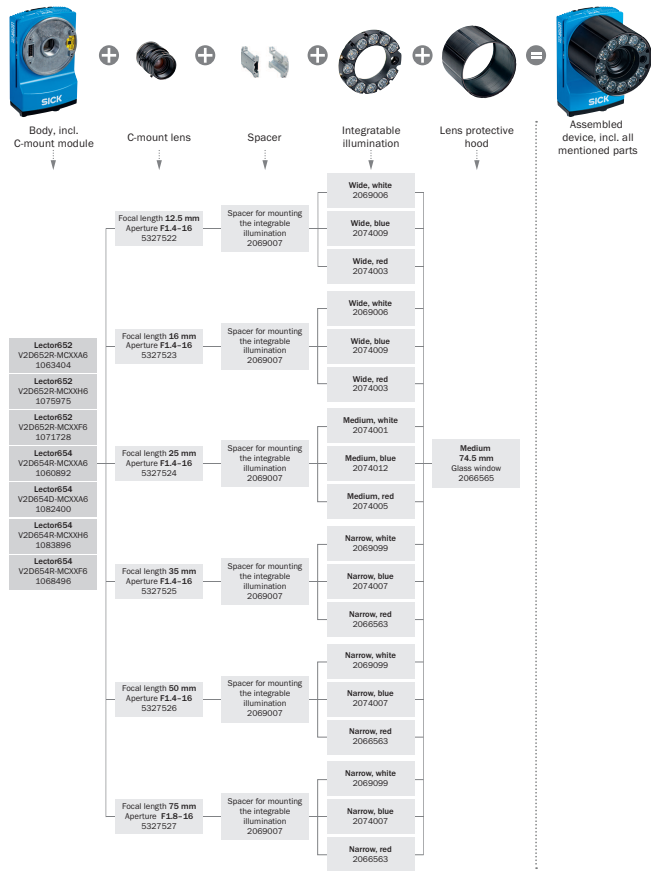

Recommended accessories

Other models and accessories → www.sick.com/Lector64x_Lector65x

| | Brief description | Type | Part no. |
|---|--|--------------------|----------|
| Plug connectors and cables | | | |
|  | <ul style="list-style-type: none"> Connection type head A: Male connector, M12, 8-pin, straight, X-coded Connection type head B: Male connector, RJ45, 8-pin, straight Signal type: Ethernet, Gigabit Ethernet Cable: 2 m, 8-wire, PUR, halogen-free Description: Ethernet, Gigabit Ethernet, shielded Application: Zones with oils and lubricants | YM2X18-020EG1MRJA8 | 2106258 |

Recommended services

Additional services → www.sick.com/Lector64x_Lector65x

| | Type | Part no. |
|--|--|----------|
| Performance check | | |
| <ul style="list-style-type: none"> • Product area: Image-based code readers • Range of services: Inspection of defined functions, e.g., reading performance • Travel expenses: The prices do not include travel costs such as hotel, flight, travel time and expenses. • Duration: Additional work will be invoiced separately | Performance check Lector | 1608207 |
| Maintenance | | |
| <ul style="list-style-type: none"> • Product area: Image-based code readers • Range of services: Inspection, analysis and restoring of defined functions, Inspection and adaptation of previously defined functions of possible Lector6xx illumination, code configuration, trigger and digital inputs, interfaces and digital outputs as well as data processing • Duration: Additional work will be invoiced separately • Travel expenses: The prices do not include travel costs such as hotel, flight, travel time and expenses. | Maintenance Lector | 1611421 |
| Commissioning | | |
| <ul style="list-style-type: none"> • Product area: Image-based code readers • Range of services: Inspection of connection, fine adjustment, optimization of parameters of SICK product as well as tests, Set-up of previously defined functions of possible illumination, code configuration, trigger and digital inputs, interfaces and digital outputs as well as data processing • Travel expenses: The prices do not include travel costs such as hotel, flight, travel time and expenses. • Duration: Additional work will be invoiced separately | Commissioning Lector | 1608206 |
| Extended warranty | | |
| <ul style="list-style-type: none"> • Product area: Identification solutions, machine vision, Detection and ranging solutions, safety camera sensors, Safety laser scanners, Safety radar sensors • Range of services: The services correspond to the scope of the statutory manufacturer warranty (SICK general terms of delivery). • Duration: Five-year warranty from delivery date. | Extended warranty for a total of five years from delivery date | 1680671 |
| Service agreements | | |
| <ul style="list-style-type: none"> • Product area: Robot guidance systems, Track and trace systems, Driver assistance systems, Object detection systems, Profiling systems, Gateway systems, Quality control systems • Range of services: Maintenance, Troubleshooting, extended warranty, 8/5 remote support, 8/5 help desk • Duration: Duration is arranged individually with the customer and defined in the contract | Bronze service agreements for Systems | 1616164 |

SICK AT A GLANCE

SICK is one of the leading manufacturers of intelligent sensors and sensor solutions for industrial applications. A unique range of products and services creates the perfect basis for controlling processes securely and efficiently, protecting individuals from accidents and preventing damage to the environment.

We have extensive experience in a wide range of industries and understand their processes and requirements. With intelligent sensors, we can deliver exactly what our customers need. In application centers in Europe, Asia and North America, system solutions are tested and optimized in accordance with customer specifications. All this makes us a reliable supplier and development partner.

Comprehensive services complete our offering: SICK LifeTime Services provide support throughout the machine life cycle and ensure safety and productivity.

For us, that is “Sensor Intelligence.”

WORLDWIDE PRESENCE:

Contacts and other locations –www.sick.com