



VL18-4P2240V

V18V

CYLINDRICAL PHOTOELECTRIC SENSORS

SICK
Sensor Intelligence.



Ordering information

Type	Part no.
VL18-4P2240V	6035497

Other models and accessories → www.sick.com/V18V

Illustration may differ



Detailed technical data

Features

Functional principle	Photoelectric retro-reflective sensor
Functional principle detail	Dual lens
Dimensions (W x H x D)	18 mm x 18 mm x 83 mm
Housing design (light emission)	Cylindrical
Housing length	83 mm
Thread diameter (housing)	M18 x 1
Optical axis	Axial
Sensing range max.	0.035 m ... 4.5 m ¹⁾
Sensing range	0.035 m ... 4 m ¹⁾
Focus	3°
Type of light	Visible red light
Light source	LED ²⁾
Light spot size (distance)	Ø 60 mm (1 m)
Angle of dispersion	3°
Wave length	660 nm
Adjustment	Single teach-in button (Sensing range) Manual, via Touch-Teach-in
Special feature	Detecting transparent objects
Special applications	Hygienic and washdown zones, Detecting transparent objects

¹⁾ Reflector PL80A.

²⁾ Average service life: 100,000 h at T_J = +25 °C.

Mechanics/electronics

Supply voltage	10 V DC ... 30 V DC ¹⁾
Ripple	± 10 % ²⁾
Current consumption	35 mA ³⁾
Switching output	PNP ⁴⁾
Switching mode	Light/dark switching ⁴⁾
Switching mode selector	Selectable via L/D control cable
Signal voltage PNP HIGH/LOW	Approx. VS – 2.0 V / 0 V
Output current I_{max.}	≤ 100 mA
Response time	≤ 1 ms ⁵⁾
Switching frequency	500 Hz ⁶⁾
Attenuation along light beam	≥ 20 %
Connection type	Male connector M12, 4-pin ⁷⁾
Circuit protection	A ⁸⁾ B ⁹⁾ C ¹⁰⁾ D ¹¹⁾
Protection class	III
Weight	120 g
Housing material	Stainless steel, Stainless steel V4A (1.4404, 316L)
Optics material	Plastic, Plan, PPS (Grilamid)
Enclosure rating	IP67 IP68 IP69K ¹²⁾
Special feature	Detecting transparent objects
Ambient operating temperature	–25 °C ... +80 °C ¹³⁾
Ambient temperature, storage	–40 °C ... +80 °C
UL File No.	FDA, UL No. NRKH.E181493 & cUL No. NRKH7.E181493

¹⁾ Limit values.

²⁾ May not exceed or fall below U_v tolerances.

³⁾ Without load, at VS 30 V DC.

⁴⁾ Control wire open: dark switching D.ON.

⁵⁾ Signal transit time with resistive load.

⁶⁾ With light/dark ratio 1:1.

⁷⁾ With gold plated contact pins, PPS with FDA certificate.

⁸⁾ A = V_S connections reverse-polarity protected.

⁹⁾ B = interference suppression.

¹⁰⁾ D = outputs overcurrent and short-circuit protected.

¹¹⁾ D = inputs and output reverse-polarity protected.

¹²⁾ With correct mounted IP69K connector.

¹³⁾ +100 °C at max 15 minutes.

Classifications

eCl@ss 5.0	27270902
eCl@ss 5.1.4	27270902
eCl@ss 6.0	27270902

eCl@ss 6.2	27270902
eCl@ss 7.0	27270902
eCl@ss 8.0	27270902
eCl@ss 8.1	27270902
eCl@ss 9.0	27270902
eCl@ss 10.0	27270902
eCl@ss 11.0	27270902
eCl@ss 12.0	27270902
ETIM 5.0	EC002717
ETIM 6.0	EC002717
ETIM 7.0	EC002717
ETIM 8.0	EC002717
UNSPSC 16.0901	39121528

Connection type

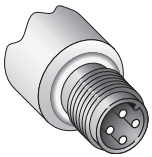

Connection diagram

Cd-087

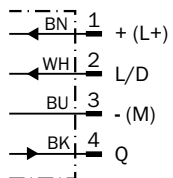

Characteristic curve

VL18V, clear material detection

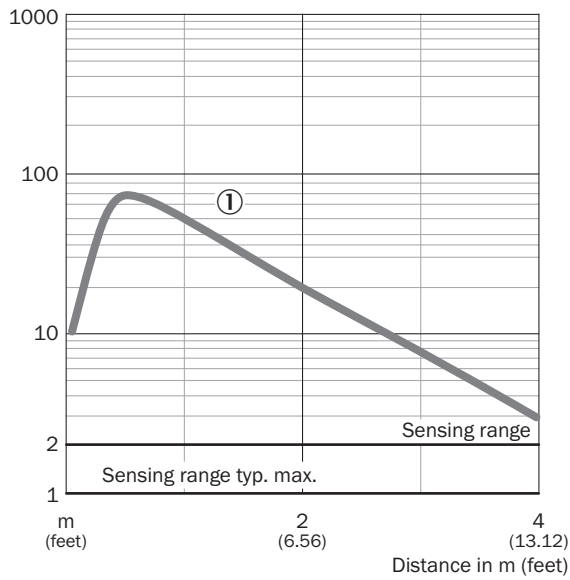

① Reflector PL80A

Sensing range diagram

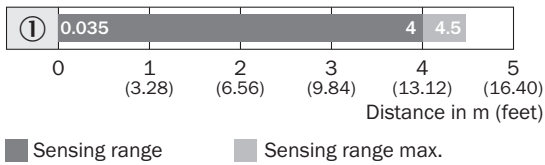

| 1 | PL80A

Adjustments

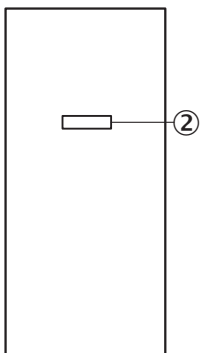

② Sensing range adjustment: Touch-Teach-In

Dimensional drawing (Dimensions in mm (inch))

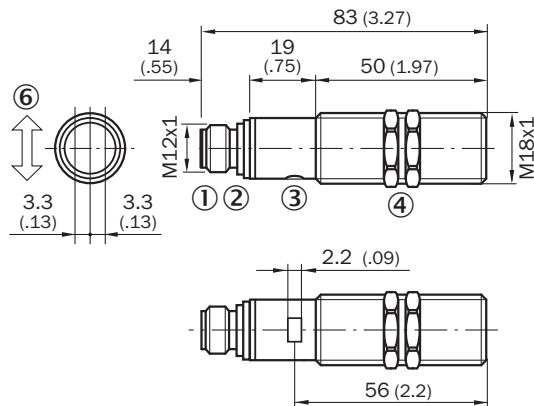

VTF18V, VTE18V



- ① M12 male device connector, 4-pin
- ② Sensing range adjustment: Touch-Teach-In
- ③ Status indicator LED, green: signaling Touch-Teach-in
- ④ Yellow LED indicator: lights continuously: Reception signal > reserve factor 2 - blinks: Reception signal < reserve factor 2 but > switching threshold 1
- ⑤ Fastening nuts (2 x); width across 24, stainless steel

Recommended accessories

Other models and accessories → www.sick.com/V18V

	Brief description	Type	Part no.
Mounting brackets and plates			
	Universal mounting bracket for reflectors, steel, zinc coated	BEF-WN-REFX	2064574
Plug connectors and cables			
	Head A: female connector, M12, 4-pin, straight Head B: Flying leads Cable: Sensor/actuator cable, PVC, unshielded, 5 m This product is generally resistant to chemical cleaning agents (see ECOLAB). Please do not use cleaning agents of any other kind., Not resistant against lactic acid & hydrogen peroxide (H2O2)	DOL-1204-G05MNI	6052615
Reflectors			
	Chemically resistant, screw connection, 52 mm x 62 mm, plastic, Screw-on, 2 hole mounting	P250 CHEM	5321097

SICK AT A GLANCE

SICK is one of the leading manufacturers of intelligent sensors and sensor solutions for industrial applications. A unique range of products and services creates the perfect basis for controlling processes securely and efficiently, protecting individuals from accidents and preventing damage to the environment.

We have extensive experience in a wide range of industries and understand their processes and requirements. With intelligent sensors, we can deliver exactly what our customers need. In application centers in Europe, Asia and North America, system solutions are tested and optimized in accordance with customer specifications. All this makes us a reliable supplier and development partner.

Comprehensive services complete our offering: SICK LifeTime Services provide support throughout the machine life cycle and ensure safety and productivity.

For us, that is “Sensor Intelligence.”

WORLDWIDE PRESENCE:

Contacts and other locations –www.sick.com