



Power contactor
BF230

Product designation

Product type designation

Contact characteristics

Number of poles	Nr.	4
Rated insulation voltage U _i IEC/EN	V	1000
Rated impulse withstand voltage U _{imp}	kV	8
Operational frequency	min	Hz 25
	max	Hz 400
IEC Conventional free air thermal current I _{th}	A	350
Operational current I _e	AC-1 (≤40°C)	A 350
	AC-1 (≤55°C)	A 290
	AC-1 (≤70°C)	A 250
	AC-3 (≤440V ≤55°C)	A 230
	AC-4 (400V)	A 110
Rated operational current AC-3 (T≤55°C)	230V	A 230
	400V	A 230
	415V	A 230
	440V	A 230
	500V	A 184
	690V	A 165
	1000V	A 100
Rated operational power AC-1 (T≤40°C)	230V	kW 132
	400V	kW 230
	500V	kW 253
	690V	kW 397
IEC max current I _e in DC1 with L/R ≤ 1ms with 1 poles in series	≤24V	A 350
	48V	A 350
	75V	A 350
	110V	A 145
	220V	A –
IEC max current I _e in DC1 with L/R ≤ 1ms with 2 poles in series	≤24V	A 350
	48V	A 350
	75V	A 350
	110V	A 270
	220V	A 225
IEC max current I _e in DC1 with L/R ≤ 1ms with 3 poles in series	≤24V	A 350
	48V	A 350
	75V	A 350

	110V	A	270
	220V	A	270
	330V	A	225
<hr/>			
IEC max current I _e in DC1 with L/R ≤ 1ms with 4 poles in series			
	≤24V	A	350
	48V	A	350
	75V	A	350
	110V	A	350
	220V	A	350
<hr/>			
IEC max current I _e in DC3-DC5 with L/R ≤ 15ms with 1 poles in series			
	≤24V	A	350
	48V	A	350
	75V	A	250
	110V	A	135
	220V	A	–
<hr/>			
IEC max current I _e in DC3-DC5 with L/R ≤ 15ms with 2 poles in series			
	≤24V	A	350
	48V	A	350
	75V	A	250
	110V	A	225
	220V	A	180
<hr/>			
IEC max current I _e in DC3-DC5 with L/R ≤ 15ms with 3 poles in series			
	≤24V	A	350
	48V	A	350
	75V	A	250
	110V	A	250
	220V	A	225
	330V	A	180
<hr/>			
IEC max current I _e in DC3-DC5 with L/R ≤ 15ms with 4 poles in series			
	≤24V	A	350
	48V	A	350
	75V	A	250
	110V	A	250
	220V	A	225
	330V	A	210
	460V	A	180
<hr/>			
Short-time allowable current for 10s (IEC/EN60947-1)		A	1840
<hr/>			
Protection fuse			
	gG (IEC)	A	400
	aM (IEC)	A	250
<hr/>			
Making capacity (RMS value)		A	2300
<hr/>			
Breaking capacity at voltage			
	440V	A	1840
	500V	A	1472
	690V	A	1296
<hr/>			
Resistance per pole (average value)		mΩ	0.18
<hr/>			
Power dissipation per pole (average value)			
	I _{th}	W	21
	AC-3	W	9.3
<hr/>			
Tightening torque for terminals			
	min	Nm	18
	max	Nm	18
	min	I _{bin}	159
	max	I _{bin}	159

Tightening torque for coil terminal

min	Nm	0.8
max	Nm	1

Power terminal protection according to IEC/EN 60529

IP00

Mechanical features

Operating position

normal	Vertical plan
allowable	±30°

Fixing

Screw

Weight

g 4000

Operations

Mechanical life

cycles 10000000

Electrical life

cycles 1000000

Safety related data

Performance level B10d according to EN/ISO 13489-1

rated load	cycles	1000000
------------	--------	---------

EMC compatibility

yes

AC coil operating

Rated AC voltage at 50/60Hz, 60Hz

min	V	60
max	V	130

AC operating voltage

of 50/60Hz coil powered at 50Hz
pick-up

min	%Us	80 Us min
max	%Us	110 Us max

drop-out

max	%Us	≤70 Us min
-----	-----	------------

of 50/60Hz coil powered at 60Hz
pick-up

min	%Us	80 Us min
max	%Us	110 Us max

drop-out

max	%Us	≤70 Us min
-----	-----	------------

AC average coil consumption at 20°C

of 50/60Hz coil powered at 50Hz

in-rush	VA	160...230
holding	VA	1.5...3.0

of 50/60Hz coil powered at 60Hz

in-rush	VA	160...230
holding	VA	1.5...3.0

of 60Hz coil powered at 60Hz

in-rush	VA	160...230
holding	VA	1.5...3.0

Dissipation at holding ≤20°C 50Hz

W 1.5...3.0

DC coil operating

DC rated control voltage

min	V	60
max	V	130

DC operating voltage

pick-up

min	%Us	85 Us min
max	%Us	110 Us max

drop-out			
		max	%Us ≤70 Us min
Average coil consumption ≤20°C			
	in-rush	W	160...230
	holding	W	1.5...3.0
Max cycles frequency			
Mechanical operation		cycles/h	1000
Operating times			
Average time for Us control			
in AC			
Closing NO			
		min	ms 50
		max	ms 100
Opening NO			
		min	ms 30
		max	ms 75
UL technical data			
Yielded mechanical performance			
for three-phase AC motor			
	200/208V	HP	75
	220/230V	HP	75
	460/480V	HP	150
	575/600V	HP	200
General USE			
Contactor			
	AC current	A	350
Short-circuit protection fuse, 600V			
High fault			
	Short circuit current	kA	100
	Fuse rating	A	400
	Fuse class		J
Standard fault			
	Short circuit current	kA	10
	Fuse rating	A	400
	Fuse class		RK5
Ambient conditions			
Temperature			
Operating temperature			
	min	°C	-40
	max	°C	70
Storage temperature			
	min	°C	-50
	max	°C	80
Max altitude			
		m	3000
Resistance & Protection			
Pollution degree			
			3
Dimensions			

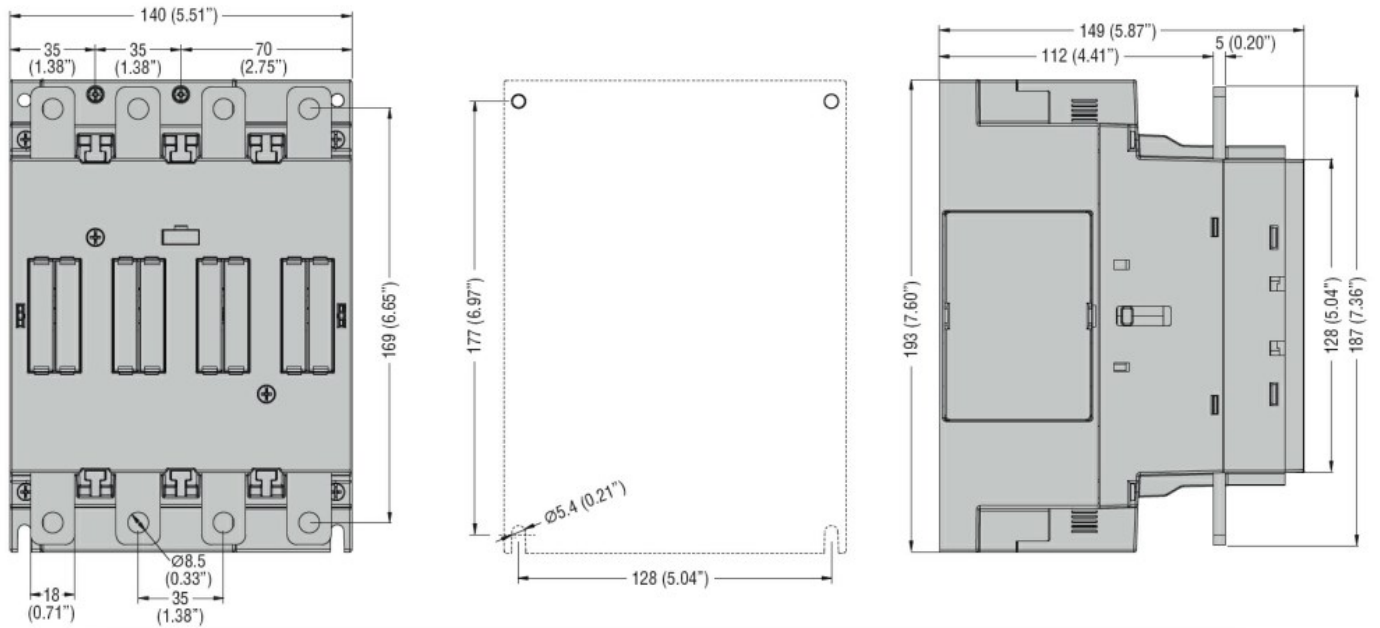

Wiring diagrams

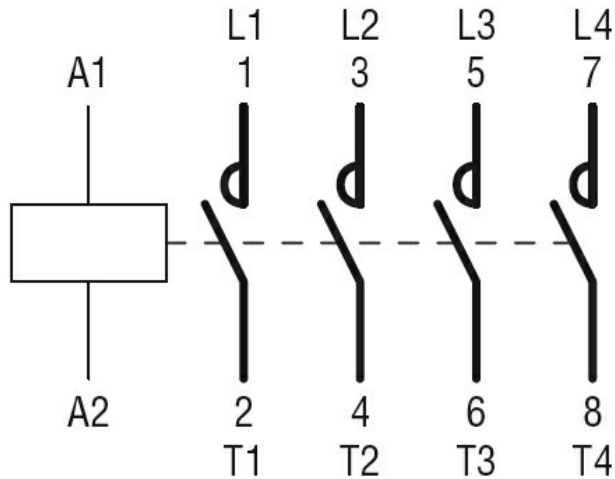

Certifications and compliance

Compliance

CSA C22.2 n° 60947-1

CSA C22.2 n° 60947-4-1

IEC/EN/BS 60947-1

IEC/EN/BS 60947-4-1

UL 60947-1

UL 60947-4-1

Certificates

cULus

ETIM classification

ETIM 8.0

EC000066 -
Power contactor,
AC switching