

SPZ-006-AD-D

SICK
Sensor Intelligence.



Ordering information

Type	Part no.
SPZ-006-AD-D	2029192

Other models and accessories → www.sick.com/

Detailed technical data

Technical specifications

Accessory group	Shaft adaptation
Accessory family	Collets and clamping rings
Description	Collet for through hollow shaft, shaft diameter 6 mm, outer diameter 14 mm
Shaft diameter	6 mm
Diameter	14 mm

Classifications

eCl@ss 5.0	21020701
eCl@ss 5.1.4	21020701
eCl@ss 6.0	21022190
eCl@ss 6.2	21022190
eCl@ss 7.0	21041712
eCl@ss 8.0	21041712
eCl@ss 8.1	21041712
eCl@ss 9.0	21041712
eCl@ss 10.0	21041712
eCl@ss 11.0	21041712
eCl@ss 12.0	21041712
ETIM 5.0	EC002384
ETIM 6.0	EC002384
ETIM 7.0	EC002384
ETIM 8.0	EC002384
UNSPSC 16.0901	27112104

Dimensional drawing (Dimensions in mm (inch))

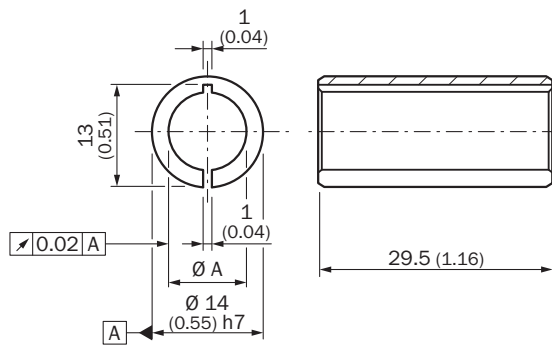

SICK AT A GLANCE

SICK is one of the leading manufacturers of intelligent sensors and sensor solutions for industrial applications. A unique range of products and services creates the perfect basis for controlling processes securely and efficiently, protecting individuals from accidents and preventing damage to the environment.

We have extensive experience in a wide range of industries and understand their processes and requirements. With intelligent sensors, we can deliver exactly what our customers need. In application centers in Europe, Asia and North America, system solutions are tested and optimized in accordance with customer specifications. All this makes us a reliable supplier and development partner.

Comprehensive services complete our offering: SICK LifeTime Services provide support throughout the machine life cycle and ensure safety and productivity.

For us, that is “Sensor Intelligence.”

WORLDWIDE PRESENCE:

Contacts and other locations –www.sick.com