

Part number

MAVS 16.40



Hood, EMC series, with 4 pegs, M40 top cable entry, size "77.27", high construction

Product description		Material properties	
Product type	Hood	RoHS conformity	Compliant
Series	EMC	China RoHS - EFUP	E
Closing type	With 4 pegs	REACH SVHC substances	No
Size	Size 77.27	Approvals / Standards	
Cable entry	Top cable entry M40	Certifications	DNV, BV
Specification	High construction	UL	ECBT2
Technical data		cUL	ECBT8
IP degree of protection	IP65 / IP66 / IP69	General ordering information	
Further technical details		EAN13 code	8015747138376
Weight	178,00 g	eCl@ss 8.1	27440202
Operating temperature range (min, max)	-40°C...+125°C	ETIM 7.0	EC000437
		Packaging Information	
		Sub-packaging weight	0,18 kg
		Sub-packaging description	Plastic packaging
		Sub-packaging quantity	1 Pcs
		Sub-packaging EAN barcode	8015747138888

Part number

MAVS 16.40



Catalogue drawings

CHOS (CAOS) - MHOS (MAOS)



CHVS (CAVS) - MHVS (MAVS)

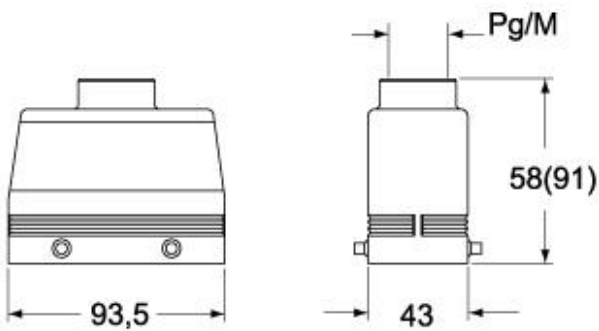

CHCS G

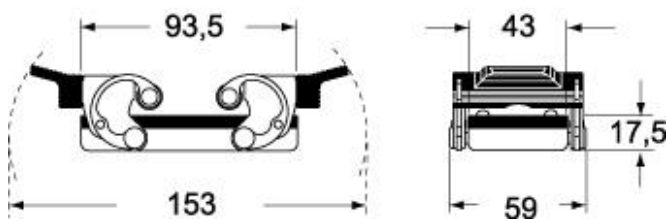

Notes

Dimensions shown in mm are not binding and may be changed without notice.