

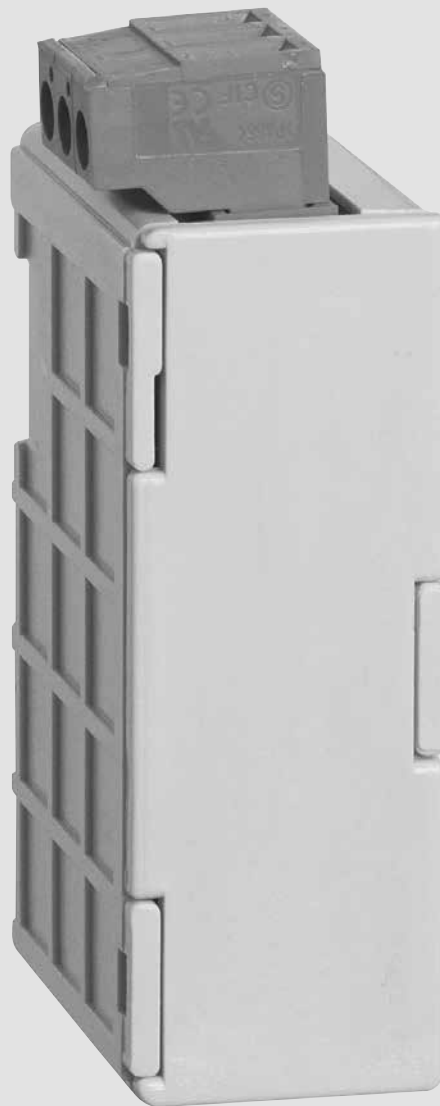

Analog outputs module for EMDX³ premium multifunction meter

Manuel d'installation • Installation manual





Sommaire

Opérations préalables	4
Présentation	5
Installation	6
Programmation	8
Caractéristiques techniques	16
Lexique des abréviations	17

Contents

<i>Preliminary operations</i>	4
<i>Presentation</i>	5
<i>Installation</i>	6
<i>Programming</i>	8
<i>Technical characteristics</i>	16
<i>Glossary of abbreviation</i>	17

Sommario

Operazioni preliminari	4
Presentazione	5
Installazione	6
Programmazione	8
Caratteristiche tecniche	16
Elenco delle abbreviazioni	17

Indice

<i>Operaciones previas</i>	4
<i>Presentación</i>	5
<i>Instalación</i>	6
<i>Programación</i>	8
<i>Características técnicas</i>	16
<i>Léxico de las abreviaciones</i>	17

Indice

Operações preliminares	4
Apresentação	5
Instalação	6
Programação	8
Características técnicas	16
Léxico das abreviaturas	17

• Opérations préalables

Au moment de la réception du colis contenant le module option, il est nécessaire de vérifier les points suivants :

- l'état de l'emballage,
- le produit n'a pas eu de dommage pendant le transport,
- la référence de l'appareil est conforme à votre commande,
- l'emballage comprend le produit,
- une notice d'utilisation.

• Preliminary operations

Check the following points as soon as you receive the optional module package:

- *the packing is in good condition,*
- *the product has not been damaged during transit,*
- *the product reference number conforms to your order,*
- *the package contains the product,*
- *the operating instructions.*

• Operazioni preliminari

Al momento del ricevimento della scatola contenente il modulo accessorio, è necessario verificare i seguenti punti:

- *lo stato dell'imballo;*
- *l'assenza di danneggiamenti o rotture dovuti al trasporto;*
- *la rispondenza tra codice dell'apparecchio e codice ordinato;*
- *la presenza nell'imballo sia dell'articolo (comprensivo di 1 morsettiera rimovibile) che del foglio istruzioni*

• Operaciones previas

Al recibir el paquete que contiene el módulo opcional, será necesario verificar los aspectos siguientes:

- *estado del embalaje;*
- *que el producto no se haya dañado durante el transporte;*
- *que la referencia del Aparato esté conforme con su pedido;*
- *el embalaje incluye el producto;*
- *el manual de utilización.*

• Operações preliminares

Na altura da recepção da encomenda do módulo opção, é necessário verificar os seguintes pontos:

- o estado da embalagem;
- se o produto não foi danificado durante o transporte;
- se a referência do Aparelho está acordo com a sua encomenda;
- dentro da embalagem encontrase realmente o produto;
- se existe um manual de utilização.

• Présentation

Ce module option doit être connecté aux produits **4 120 53**. Il met à disposition 2 sorties analogiques 0/4 – 20 mA entièrement configurables (seuil à 0 ou 4 mA et seuil à 20 mA) sur V, I, U, P+, P-, Q+, Q-, ΣP+, ΣP-, ΣQ+, ΣQ-, ΣPFL, ΣPFC, F, AVG ΣP+, AVG ΣP-, AVG ΣQ+, AVG ΣQ-, AVG ΣI, T°C1, T°C2.

On peut avoir au maximum 2 modules, soit 4 sorties analogiques sur un même produit **4 120 53**.

• Presentation

*This optional module must be connected to the **4 120 53** product. It provides 2 entirely configurable 0/4-20 mA analog outputs (threshold at 0 or 4 mA and threshold at 20 mA) on V, I, U, P+, P-, Q+, Q-, ΣP+, ΣP-, ΣQ+, ΣQ-, ΣPFL, ΣPFC, F, AVG ΣP+, AVG ΣP-, AVG ΣQ+, AVG ΣQ-, AVG ΣI, T°C1, T°C2.*

*Up to a maximum of 2 modules, that is 4 analog outputs installed on one **4 120 53** product.*

• Presentazione

L'articolo deve essere collegato alla centrale e di misura **4 120 53**. Mette a disposizione 2 uscite analogiche 0/4 - 20 mA interamente configurabili (soglia a 0 o 4 mA e soglia a 20 mA) su V, I, U, P+, P-, Q+, Q-, ΣP+, ΣP-, ΣQ+, ΣQ-, ΣPFL, ΣPFC, F, AVG ΣP+, AVG ΣP-, AVG ΣQ+, AVG ΣQ-, AVG ΣI, T°C1, T°C2.

Su una stessa centrale di misura (**4 120 53**) si possono collegare al massimo due moduli **4 120 60**.

• Presentación

*Este módulo opcional se debe conectar a los productos **4 120 53**. Pone a disposición 2 salidas analógicas 0 / 4 - 20 mA totalmente configurables (umbral a 0 o 4 mA y umbral a 20 mA) en V, I, U, P+, P-, Q+, Q-, ΣP+, ΣP-, ΣQ+, ΣQ-, ΣPFL, ΣPFC, F, AVG ΣP+, AVG ΣP-, AVG ΣQ+, AVG ΣQ-, AVG ΣI, T°C1, T°C2.*

*Se puede disponer de 2 módulos como máximo, ya sea 4 salidas analógicas en un mismo productos **4 120 53***

• Apresentação

Este módulo opção deve ser ligado aos productos **4 120 53**. Coloca à sua disposição 2 saídas analógicas 0 / 4 – 20 mA inteiramente configuráveis (limite a 0 ou 4 mA e limite a 20 mA) em V, I, U, P+, P-, Q+, Q-, ΣP+, ΣP-, ΣQ+, ΣQ-, ΣPFL, ΣPFC, F, AVG ΣP+, AVG ΣP-, AVG ΣQ+, AVG ΣQ-, AVG ΣI, T°C1, T°C2.

É possível termos no máximo 2 módulos, ou seja 4 saídas analógicas num mesmo productos **4 120 53**

• **Installation • Installation • Installazione • Instalación • Instalação**

- Raccordement
- Connection
- Collegamento
- Parte trasera
- Ligação



- Le produit 4 120 53 doit être hors tension.
- *The 4 120 53 product must be disconnected.*
- Prima di collegare il modulo accertarsi che la centrale di misura 4 120 53 non sia in tensione.
- *El producto 4 120 53 deberá estar desconectado.*
- O produto 4 120 53 deve ficar desligado.

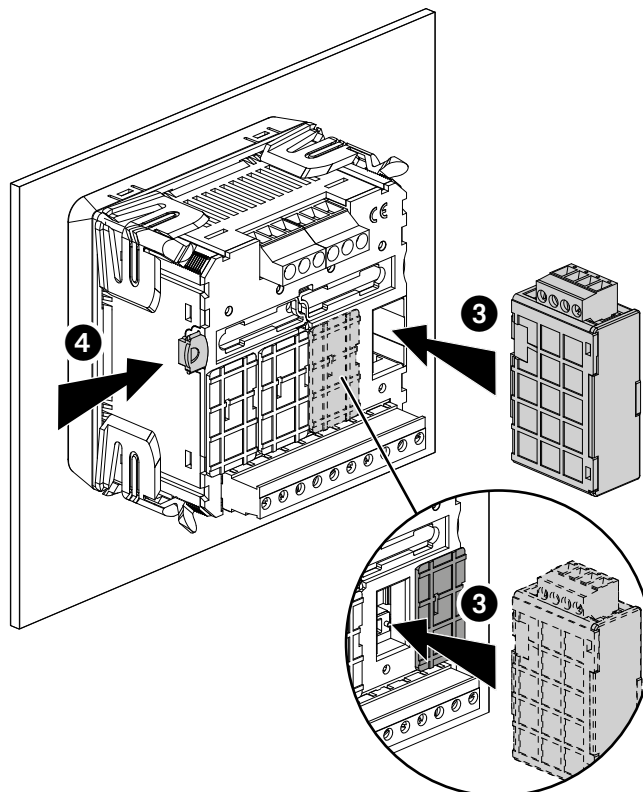
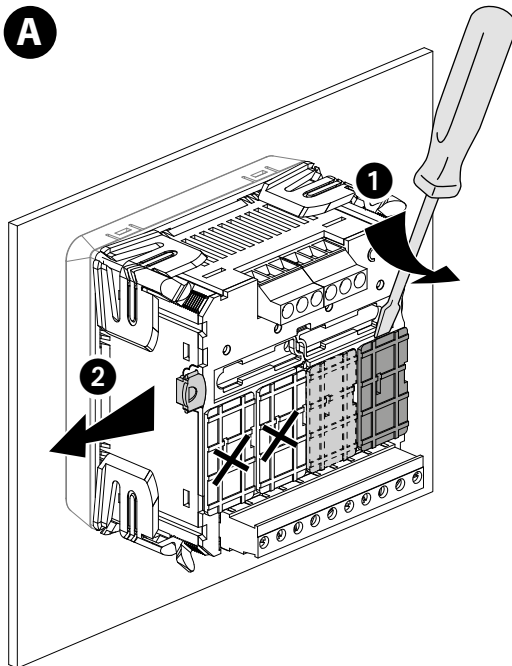

- Fixer le module
- *Fix the module*
- Fissare il modulo
- *Fije el módulo*
- Fixe o módulo

• Installation • Installation • Installazione • Instalación • Instalação

- Raccordement
- Connection
- Collegamento
- Parte trasera
- Ligaçao

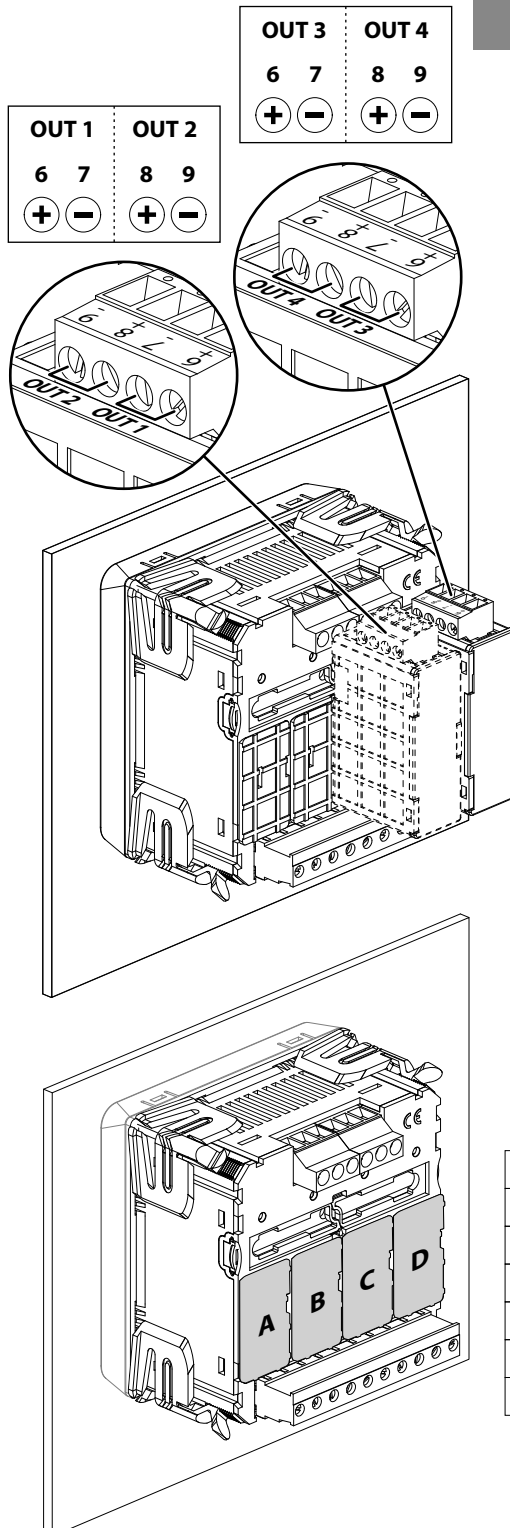

- Le produit 4 120 53 doit être hors tension.
- The 4 120 53 product must be disconnected.
- Prima di collegare il modulo accertarsi che la centrale di misura 4 120 53 non sia in tensione.
- El producto 4 120 53 deberá estar desconectado.
- O produto 4 120 53 deve ficar desligado.



- Lors de l'utilisation de quatre sorties, l'installation des deux modules doit se faire sur les deux emplacements de droite comme indiqué.
- When using the four outputs, the two modules must be installed in the two right-hand positions as shown.
- I moduli 4 120 60 possono essere collegati solo negli ultimi due spazi di destra come indicato.
- Al utilizar las cuatro salidas, la instalación de los dos módulos se hará en los dos emplazamientos de la derecha como se indica.
- Durante a utilização das quatro saídas, a instalação dos dois módulos devem fazer-se nas duas localizações da direita como indicado.



- Raccorder le bornier en respectant les indications. Remettre sous tension.
- Follow indications when connecting the terminal. Switch on voltage supply.
- Collegare i morsetti rispettando le indicazioni. Alimentare la centrale di misura.
- Conexionar respetando las indicaciones. Poner en tensión.
- Ligar o terminal de bornes respetando as indicações. Colocar sob tensão novamente.

	A	B	C	D	
4 120 55	✓	✗	✗	✗	max. 1
4 120 56	✓	✗	✗	✗	max. 1
4 120 57	✗	✗	✓	✓	max. 2
4 120 58	✗	✗	✗	✓	max. 1
4 120 59	✓	✓	✓	✓	max. 2
4 120 60	✗	✗	✓	✓	max. 2
4 120 61	✗	✓	✗	✗	max. 1

- Tableau d'associabilité
- Associability table
- Tabella di accessoriabilità
- Tabla de asociabilidad
- Tabela de associabilidade

**• Programmation • Programming • Programmazione • Programación
• Programação**

- Mot de passe 1: PASS = 1000
- Password 1: PASS = 1000
- Codice d'accesso 1: PASS = 1000
- Contraseña 1: PASS = 1000
- Senha 1: PASS = 1000

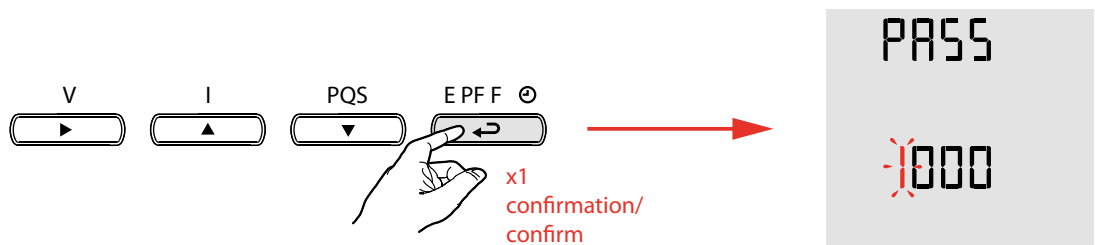
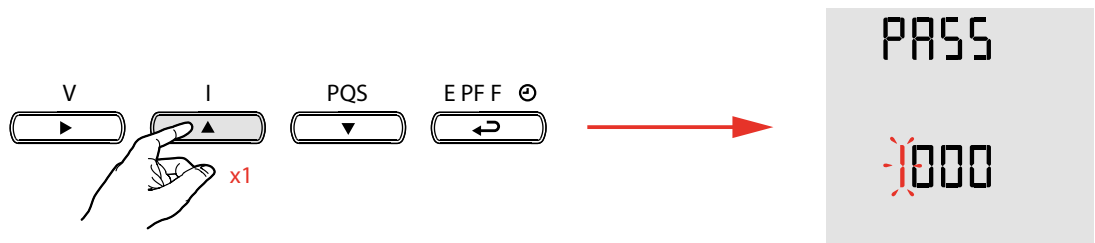
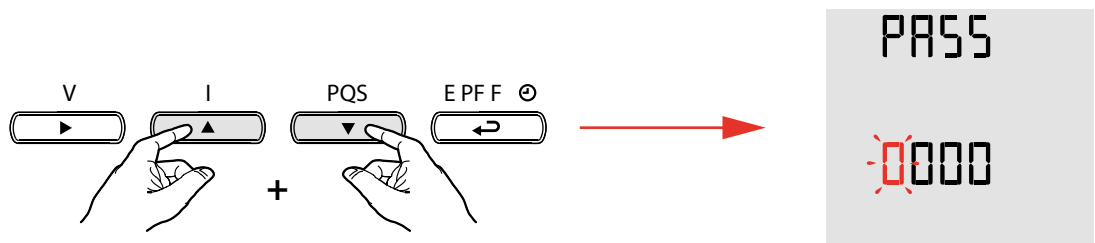

• **Programmation** • **Programming** • **Programmazione** • **Programación**
 • **Programação**

- Menu précédent
- Previous menu
- Menù precedente
- Menú anterior
- Menu precedente

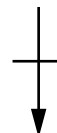

- **Type de la sortie analogique n°1** - Exemple: SPAn = 0-20 mA
- **N°1 analog output type** - Exemple: SPAn = 0-20 mA
- **Uscita analogica n°1: Assegnazione del tipo di uscita** - Esempio: SPAn = 0-20 mA
- **Tipo de la salida analógica n°1:** - Ejemplo: SPAn = 0-20 mA
- **Tipo da saída analógica n°1:** - Exemplo: SPAn = 0-20 mA

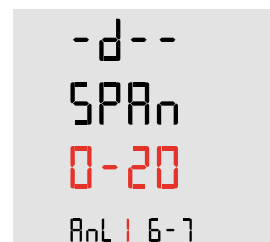
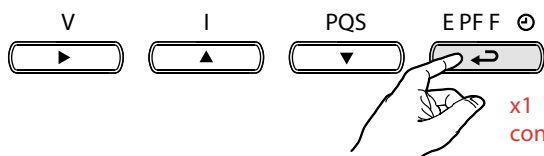
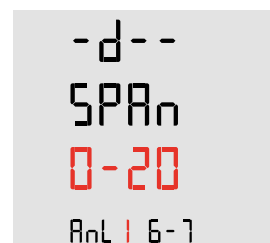
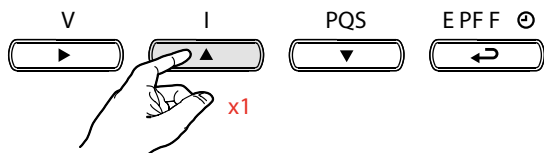
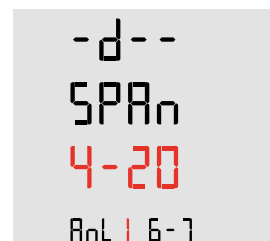

• Programmation • Programming • Programmazione • Programación • Programação

- **L'affectation de la sortie analogique n°1** - Exemple: MEAS = P1
- **N°1 analog output allocation** - Example: MEAS = P1
- **Uscita analogica n°1: Assegnazione della grandezza da controllare**- Esempio: MEAS = P1
- **Atribución de la salida analógica n°1:** - Ejemplo: MEAS = P1
- **Afectação da saída analógica n°1:** - Exemplo: MEAS = P1

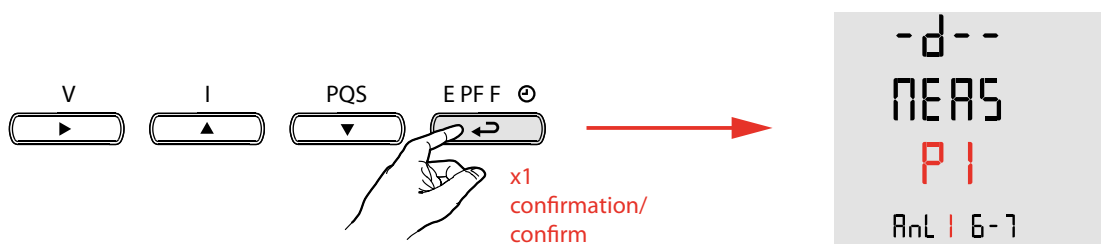
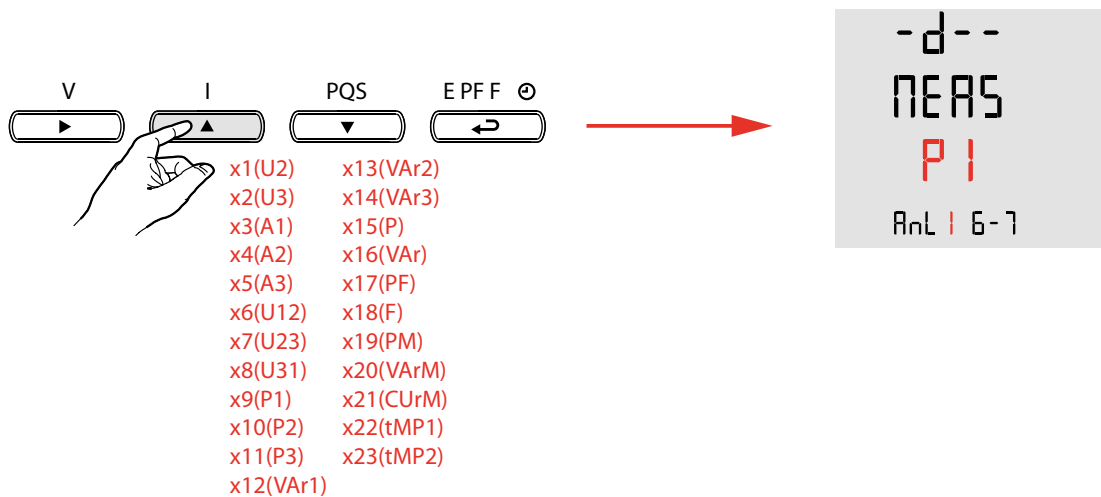
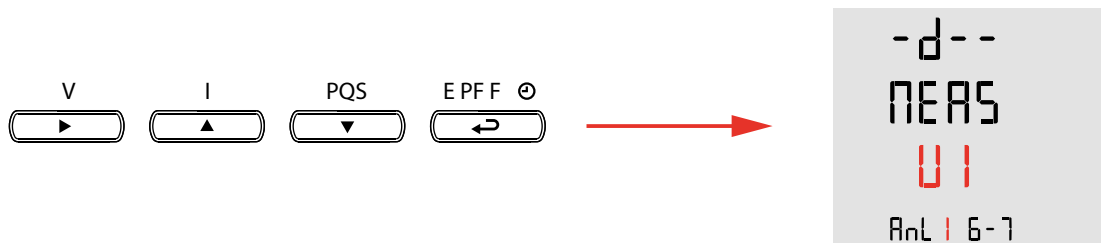

• Programmation • Programming • Programmazione • Programación • Programação

- **Sortie analogique n°1: Programmation de la valeur correspondant à 0 ou 4 mA** - Exemple: bS = -50 kW
- **N°1 analog output: Programming of the value corresponding to 0 or 4 mA** - Example: bS = -50 kW
- **Uscita analogica n°1: Programmazione del valore corrispondente a 0 oppure a 4 mA** - Esempio: bS = -50 kW
- **Salida analógica n°1: Programación del valor correspondiente a 0 o 4 mA** - Ejemplo: bS = -50 kW
- **Saída analógica n°1: Programar o valor correspondente a 0 ou 4 mA** - Exemplo: bS = -50 kW
 - Secteur positif ou négatif - Exemple: secteur négatif (dessin D1) - [seulement pour Puissances et Températures]
 - Positive or negative sector - Example: negative sector (drawing D1) - [only for Powers and Temperatures]
 - Scelta del settore positivo o negativo (figura D1) - [solo per Potenze e Temperature]
 - Sector positivo o negativo - Ejemplo: sector negativo (imagen D1) - [sólo para Potencias y Temperaturas]
 - Sector positivo o negativo: - Exemplo: sector negativo (imagem D1) - [apenas para Potências e Temperaturas]

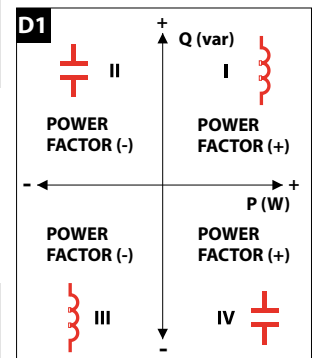
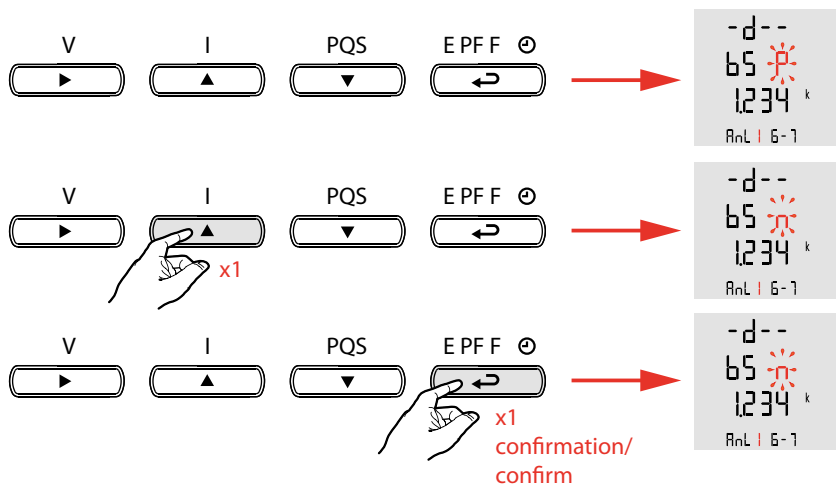

- Point décimal • *Decimal point* • Punto decimale • *Punto decimal* • Ponto decimal

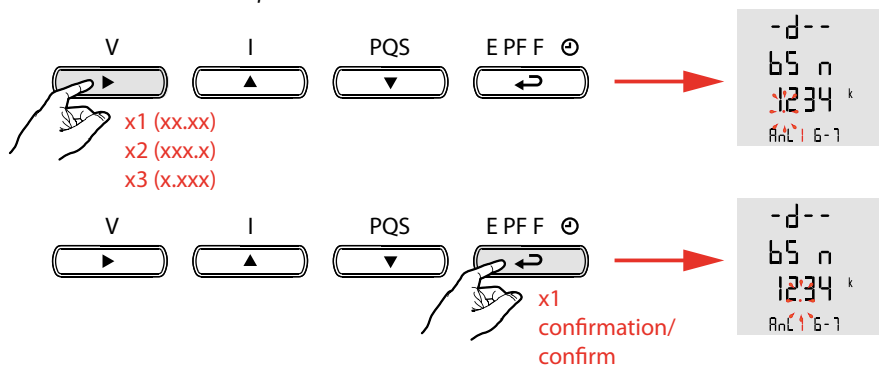

- Unité de mesure • *Metering unit* • Unità di misura • *Unidad de medida* • Unidade de medida

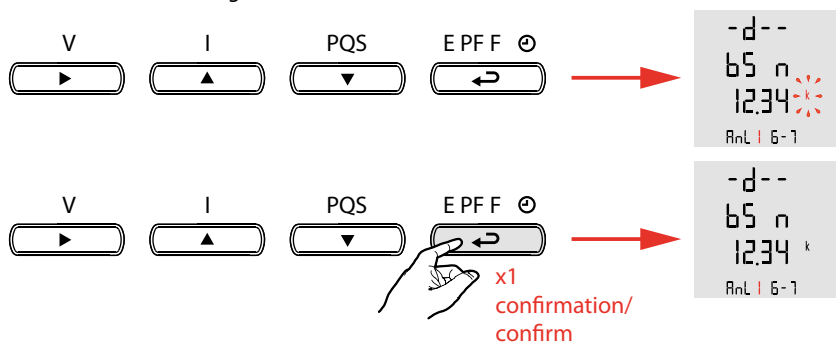

• **Programmation • Programming • Programmazione • Programación • Programação**

- **Sortie analogique n°1: Programmation de la valeur correspondant à 0 ou 4 mA** - Exemple: $bS = -50 \text{ kW}$
- **N°1 analog output: Programming of the value corresponding to 0 or 4 mA** - Example: $bS = -50 \text{ kW}$
- **Uscita analogica n°1: Programmazione del valore corrispondente a 0 oppure a 4 mA** - Esempio: $bS = -50 \text{ kW}$
- **Salida analógica n°1: Programación del valor correspondiente a 0 o 4 mA** - Ejemplo: $bS = -50 \text{ kW}$
- **Saída analógica n°1: Programar o valor correspondente a 0 ou 4 mA** - Exemplo: $bS = -50 \text{ kW}$

• Valeur • Value • Valore • Valor • Valor

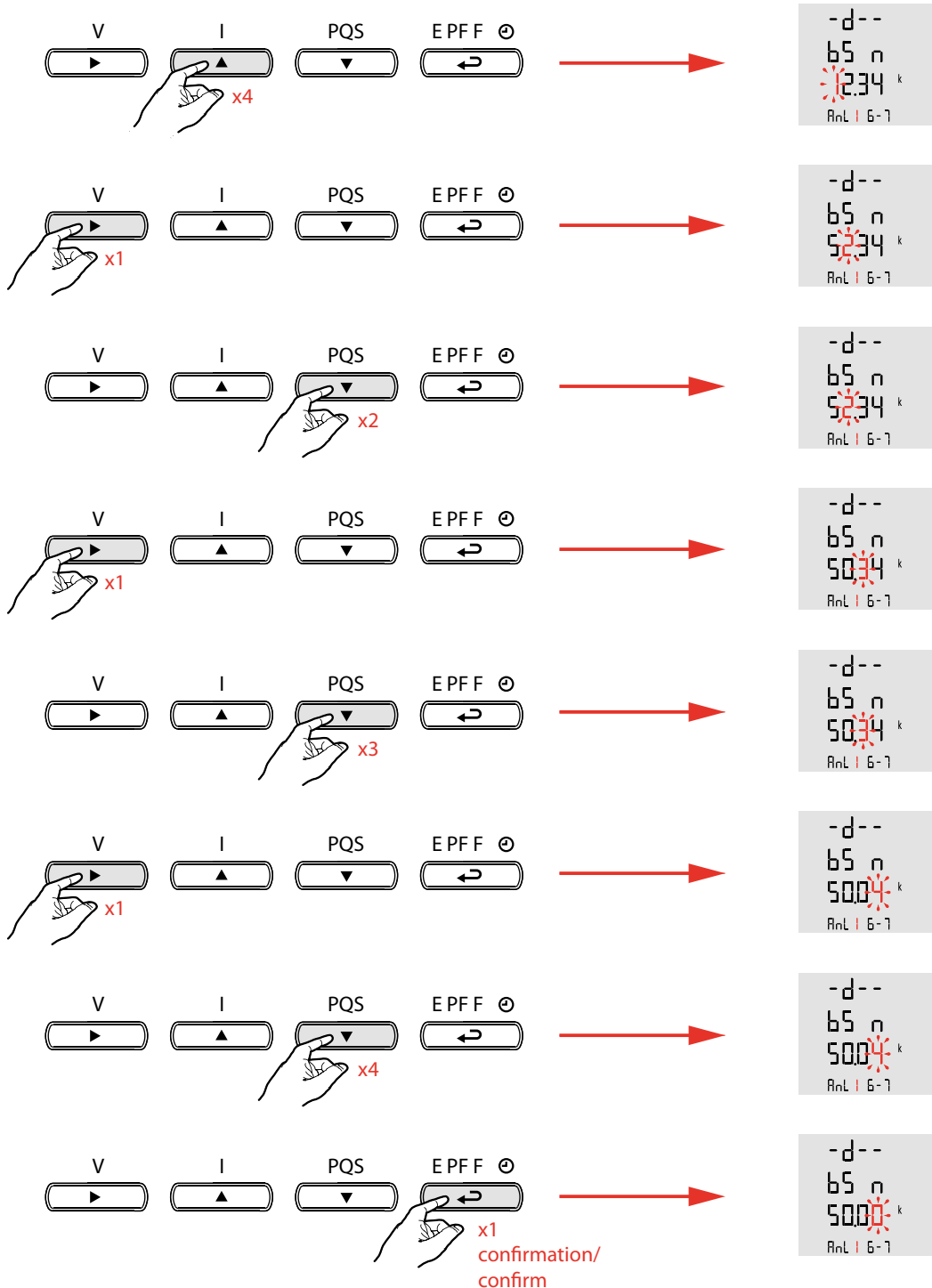

• Programmation • Programming • Programmazione • Programación • Programação

- **Sortie analogique n°1: Programmation de la valeur correspondant à 20 mA** - Exemple: ES = 50 MW
- **N°1 analog output: Programming of the value corresponding to 20 mA** - Example: ES = 50 MW
- **Uscita analogica n°1: Programmazione del valore corrispondente a 20 mA** - Esempio: ES = 50 MW
- **Salida analógica n°1: Programación del valor correspondiente a 20 mA** - Ejemplo: ES = 50 MW
- **Saída analógica n°1: Programar o valor correspondente a 20 mA** - Exemplo: ES = 50 MW
- **Secteur positif ou négatif** - Exemple: secteur négatif (dessin D1) - [seulement pour Puissances et Températures]
- **Positive or negative sector** - Example: negative sector (drawing D1) - [only for Powers and Temperatures]
- **Scelta del settore positivo o negativo** (figura D1) - [solo per Potenze e Temperature]
- **Sector positivo o negativo** - Ejemplo: sector negativo (imagen D1) - [sólo para Potencias y Temperaturas]
- **Sector positivo o negativo** - Exemplo: sector negativo (imagem D1) - [apenas para Potências e Temperaturas]

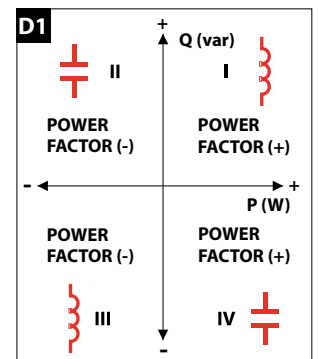
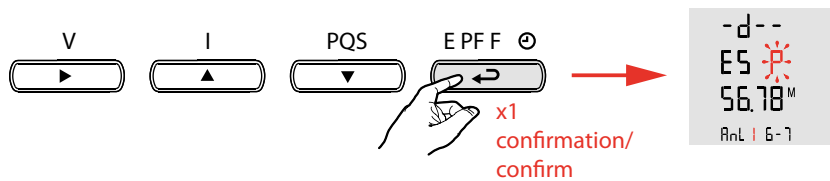
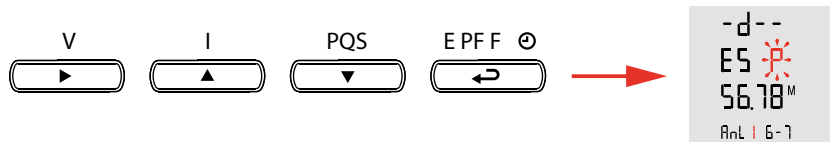

• Point décimal • Decimal point • Punto decimale • Punto decimal • Ponto decimal

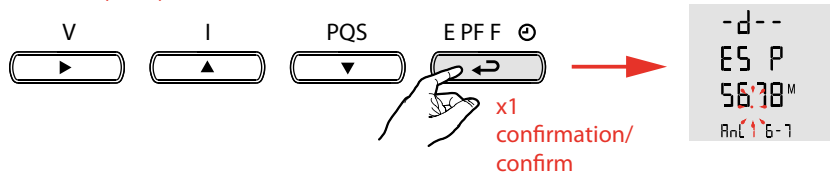
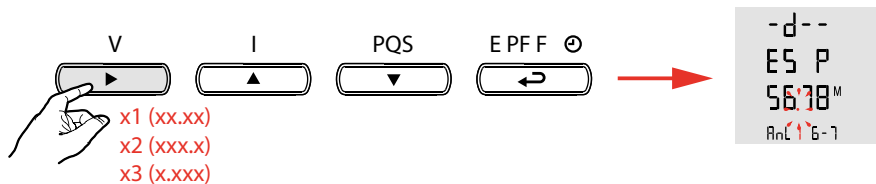

• Unité de mesure • Metering unit • Unità di misura • Unidad de medida • Unidade de medida

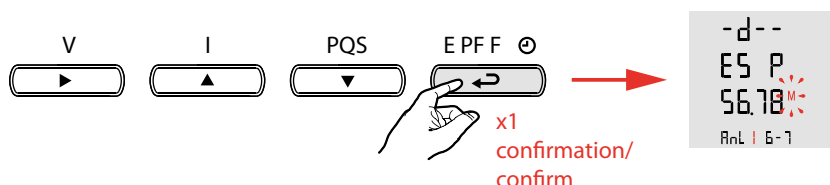
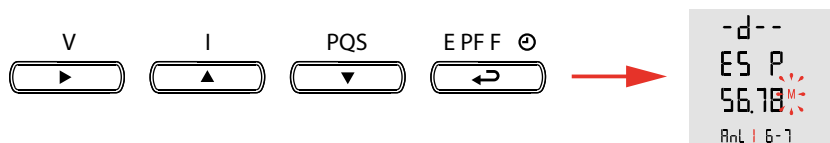

• **Programmation • Programming • Programmazione • Programación • Programação**

- **Sortie analogique n° 1: Programmation de la valeur correspondant à 20 mA** - Exemple: ES = 50 MW
- **N°1 analog output: Programming of the value corresponding to 20 mA** - Example: ES = 50 MW
- **Uscita analogica n°1: Programmazione del valore corrispondente a 20 mA** - Esempio: ES = 50 MW
- **Salida analógica n°1: Programación del valor correspondiente a 20 mA** - Ejemplo: ES = 50 MW
- **Saída analógica n°1: Programar o valor correspondente a 20 mA** - Exemplo: ES = 50 MW

• Valeur • Value • Valore • Valor • Valor

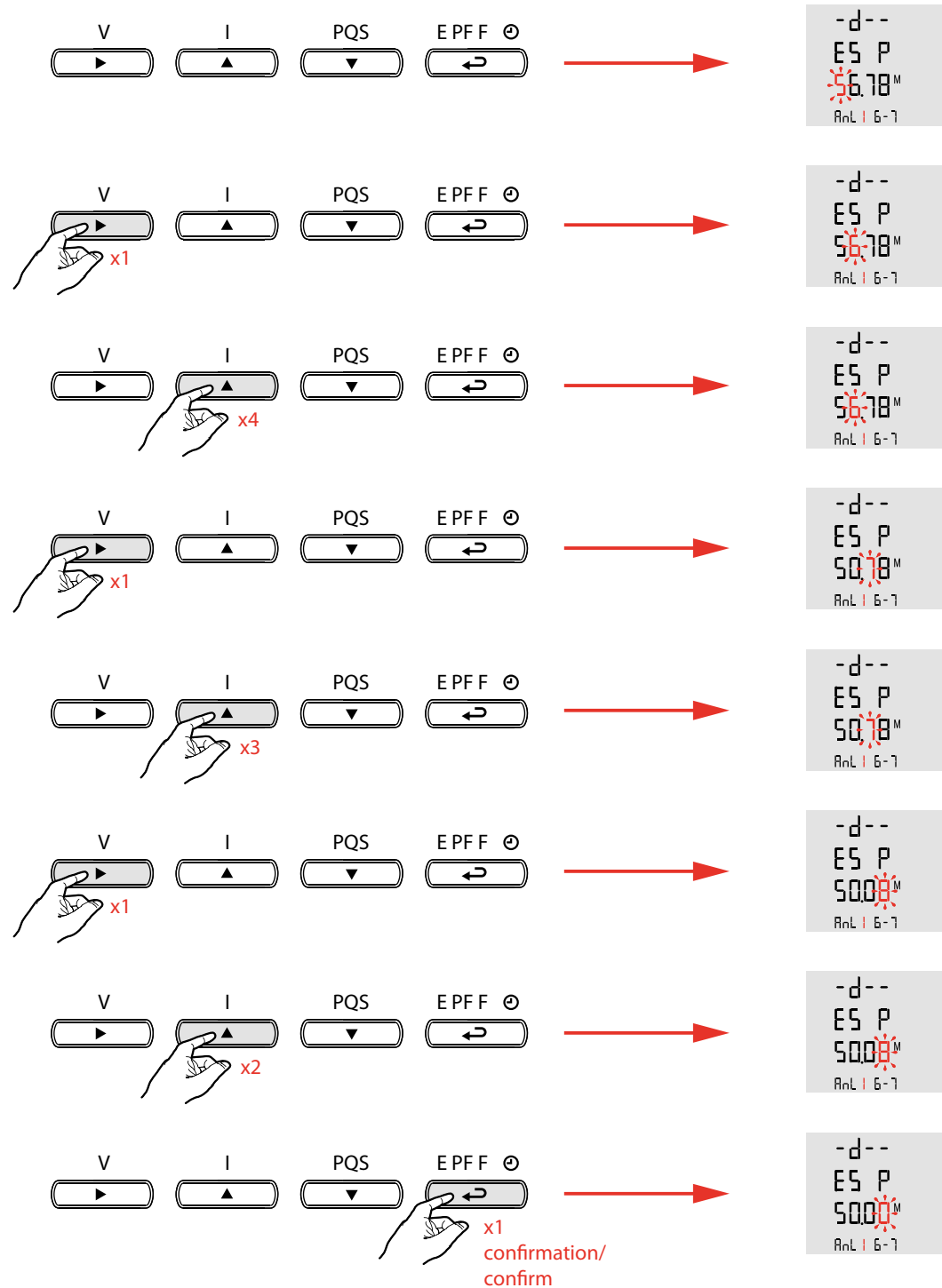

• **Programmation** • **Programming** • **Programmazione** • **Programación** • **Programação**

- **Programmation des sorties analogiques n° 2 - 3 - 4:** Procédez comme pour la sortie numéro 1
- **Programming analog outputs n° 2 - 3 - 4:** - Proceed as for output number 1
- **Programmazione delle uscite analogiche n° 2 - 3 - 4:** Procedere come per l'uscita numero 1
- **Programación de las salidas analógicas n° 2 - 3 - 4:** Proceda de la misma manera que para la salida numero 1
- **Programação das saídas analógicas n° 2 - 3 - 4:** Proceda como para a saída número 1

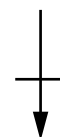

- Menu suivant
- Following menu
- Menù successivo
- Menú siguiente
- Menu seguir

- Mot de passe 2
- Password 2
- Codice d'accesso 2
- Contraseña 2
- Senha 2

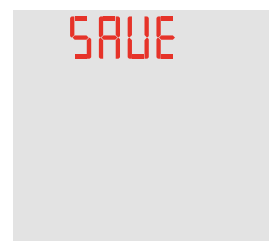
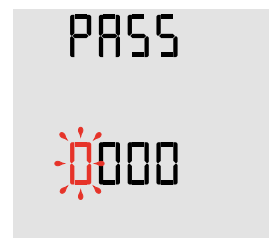
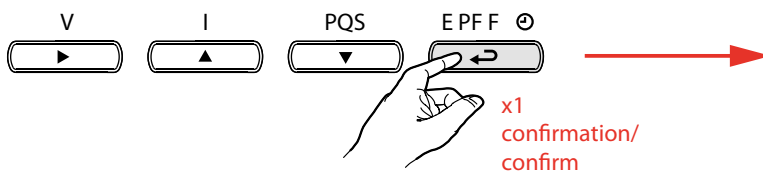

• Caractéristiques techniques

Résistance de charge	≤ 750 Ω
Temps de réponse	≤ 600 ms
Isolation galvanique	2 kV (IEC/EN 61010)
Précision (pleine échelle)	cl. 0,5

• Technical characteristics

<i>Load resistance</i>	≤ 750 Ω
<i>Response time</i>	≤ 600 ms
<i>Galvanic insulation</i>	2 kV (IEC/EN 61010)
<i>Accuracy (full scale)</i>	cl. 0,5

• Caratteristiche tecniche

Resistenza di carico	≤ 750 Ω
Tempi di risposta	≤ 600 ms
Isolamento galvanico (tensione di isolamento AC)	2 kV (IEC/EN 61010)
Precisione (piena scala)	cl. 0,5

• Características técnicas

<i>Resistencia de carga</i>	≤ 750 Ω
<i>Tiempo de respuesta</i>	≤ 600 ms
<i>Aislamiento galvánico</i>	2 kV (IEC/EN 61010)
<i>Precisión (escala completa)</i>	cl. 0,5

• Características técnicas

Resistência de carga	≤ 750 Ω
Tempo resposta	≤ 600 ms
Isolamento galvánico	2 kV (IEC/EN 61010)
Precisão (escala cheia)	cl. 0,5

• Lexique des abréviations

0-20	Signal 0-20 mA
4-20	Signal 4-20 mA
P	Puissance active totale
VAR	Puissance réactive totale
PF	Facteur de puissance
	Facteur de puissance inductif
	Facteur de puissance capacitif
F	Fréquence
A1, A2, A3	Courant I1, I2, I3
k	Kilo (ex : kA = kilo ampères)
M	Méga (ex : MA = méga ampères)
AnL1 ... AnL4	Sorties analogiques N°1 à 4
bS	Valeur à 0 ou 4 mA
ES	Valeur à 20 mA
P1, P2, P3	Puissance active P1, P2, P3
VAR1, VAR2, VAR3	Puissance réactive Q1, Q2, Q3
P M	Valeur moyenne Puissance active totale
VARM	Valeur moyenne Puissance réactive totale
CURM	Valeur moyenne Courant
tMP1	Température sonde externe 1
tMP2	Température sonde externe 2
SPAn	Affectation du type de signal 0-20 mA, 4-20 mA
U12, U23, U31	Tensions composées U12, U23, U31
U1, U2, U3	Tensions simples V1, V2, V3

• Glossary of abbreviations

0-20	Signal 0-20 mA
4-20	Signal 4-20 mA
P	Total active power
VAR	Total reactive power
PF	Power factor
	Power factor (lagging)
	Power factor (leading)
F	Frequency
A1, A2, A3	Current I1, I2, I3
k	Kilo (e.g. : kA = kilo amps)
M	Mega (e.g. : MA = mega amps)
AnL1 ... AnL4	Analogue outputs nos. 1 to 4
bS	Value at 0 or 4 mA
ES	Value at 4-20 mA
P1, P2, P3	Active power P1, P2, P3
VAR1, VAR2, VAR3	Reactive power Q1, Q2, Q3
P M	Mean value Total active power
VARM	Mean value Total reactive power
CURM	Mean value Current
tMP1	External sensor temperature 1
tMP2	External sensor temperature 2
SPAn	Allocation of signal type 0-20 mA, 4-20 mA
U12, U23, U31	Phase-to-phase voltage U12, U23, U31
U1, U2, U3	Phase-to-neutral voltage V1, V2, V3

• Elenco delle abbreviazioni

0-20	Segnale 0-20 mA
4-20	Segnale 4-20 mA
P	Potenza attiva totale
VAR	Potenza reattiva totale
PF	Fattore di Potenza
	Fattore di potenza induttivo
	Fattore di potenza capacitivo
F	Frequenza
A1, A2, A3	Correnti I1, I2, I3
k	kilo (es. / kA = kilo Ampère)
M	Mega (es. / MA = Mega Ampère)
AnL1 ... AnL4	Uscite analogiche da 1 a 4
bS	Valore a 0 o 4 mA
ES	Valore a 20 mA
P1, P2, P3	Potenze attive P1, P2, P3
VAR1, VAR2, VAR3	Potenze reattive Q1, Q2, Q3
P M	Valor medio Potenza attiva totale
VARM	Valor medio Potenza reattiva totale
CUrM	Valor medio Corrente
tMP1	Temperatura sonda esterna 1
tMP2	Temperatura sonda esterna 2
SPAn	Assegnazione del tipo di segnale 0-20 mA, 4-20 mA
U12, U23, U31	Tensioni concatenate U12, U23, U31
U1, U2, U3	Tensioni di fase V1, V2, V3

• Léxico de las abreviaciones

0-20	Signal 0-20 mA
4-20	Signal 4-20 mA
P	Potencia activa total
VAR	Potencia reactiva total
PF	Factor de potencia
	Factor de potencia inductivo
	Factor de potencia capacitivo
F	Frecuencia
A1, A2, A3	Intensidad I1, I2, I3
k	Kilo (ej.: kA = kiloamperios)
M	Mega (ej.: MA = mega amperios)
AnL1 ... AnL4	Salidas analógicas n.º 1 a 4
bS	Valor a 0 o 4 mA
ES	Valor a 20 mA
P1, P2, P3	Potencia activa P1, P2, P3
VAR1, VAR2, VAR3	Potencia reactiva Q1, Q2, Q3
P M	Valor medio Potencia activa total
VARM	Valor medio Potencia reactiva total
CUrM	Valor medio Intensidad
tMP1	Temperatura de la sonda externa 1
tMP2	Temperatura de la sonda externa 2
SPAn	Asignación del tipo de señal 0-20 mA, 4-20 mA
U12, U23, U31	Tensiones compuestas U12, U23, U31
U1, U2, U3	Tensiones simples V1, V2, V3

• Léxico de las abreviaciones

0-20	Signal 0-20 mA
4-20	Signal 4-20 mA
P	Potência activa total
VAR	Potência reactiva total
PF	Factor de potência
	Factor de potência indutivo
	Factor de potência capacitivo
F	Frequência
A1, A2, A3	Corrente I1, I2, I3
k	Kilo (ex. kA = quiloamperes)
M	Mega (ex. MA = megamperes)
AnL1 ... AnL4	Salidas analógicas n.º 1 a 4
bS	Valor a 0 o 4 mA
ES	Valor a 20 mA
P1, P2, P3	Potência activa P1, P2, P3
VAR1, VAR2, VAR3	Potência reactiva Q1, Q2, Q3
P M	Valor medio Potencia activa total
VARM	Valor medio Potencia reactiva total
CURM	Valor medio Intensidad
tMP1	Temperatura da sonda externa 1
tMP2	Temperatura da sonda externa 2
SPAN	Afectação do tipo de sinal 0-20 mA, 4-20 mA
U12, U23, U31	Tensões compostas U12, U23, U31
U1, U2, U3	Tensões simples V1, V2, V3

**World Headquarters and
International Department**

87045 LIMOGES CEDEX FRANCE

☎: 33 5 55 06 87 87

Fax : 33 5 55 06 74 55

www.legrandelectric.com

Stamp installateur - installation firm's stamp