



LFV230-XXSGATPM0220

LFV200

VIBRATING LEVEL SWITCH

SICK
Sensor Intelligence.



Illustration may differ



Ordering information

Type	Part no.
LFV230-XXSGATPM0220	6051073

Other models and accessories → www.sick.com/LFV200

Detailed technical data

Features

Medium	Fluids
Measurement	Switch
Probe length	220 mm
Process pressure	-1 bar ... 64 bar
Process temperature	-40 °C ... +100 °C
Fill material density	0.7 g/cm ³ ... 2.5 g/cm ³

Performance

Accuracy of sensor element	± 2 mm
Reproducibility	≤ 1 mm
Viscosity	0.1 mPas ... 10,000 mPas
Resolution	≤ 1 mm
Response time	500 ms
MTBF	1,25*10 ⁷ h

Electronics

Supply voltage	9.6 V DC ... 35 V DC
Residual ripple	≤ 5 V _{pp}
Power consumption	< 10 mA
Initialization time	< 2 s
VDE protection class 2	✓
Connection type	M12 round connector x 1, 4-pin
Output signal	Transistor output PNP
Hysteresis	2 mm
Output current	< 250 mA
Inductive load	≤ 1 H
Capacitive load	100 nF
Enclosure rating	IP67
Temperature drift	0.03 mm/K

Mechanics

Wetted parts	Stainless steel 1.4404
Process connection	G 1 A PN 64
Housing material	Stainless steel 1.4404, PEI

Ambient data

Ambient operating temperature	-40 °C ... +70 °C
Ambient temperature, storage	-40 °C ... +80 °C

Classifications

ECLASS 5.0	27273202
ECLASS 5.1.4	27273202
ECLASS 6.0	27273202
ECLASS 6.2	27273202
ECLASS 7.0	27273202
ECLASS 8.0	27273202
ECLASS 8.1	27273202
ECLASS 9.0	27273202
ECLASS 10.0	27273202
ECLASS 11.0	27273202
ECLASS 12.0	27273106
ETIM 5.0	EC002654
ETIM 6.0	EC002654
ETIM 7.0	EC002654
ETIM 8.0	EC002654
UNSPSC 16.0901	41111938

Type code

LFV230 type code

Certification	
XX	without
XA	Overfill protection in acc. with WHG (German Federal Water Act)
Execution / Process temperature	
S	Standard / -40 °C ... +100 °C
T	Expanded / -40 °C ... +150 °C
H	Hygiene applications / -40 °C ... +150 °C
Process connection / Material	
GB	G ¾ A, PN 64 / 316L
NB	¾" NPT, PN 64 / 316L
GA	G 1 A, PN 64 / 316L
NA	1" NPT, PN 64 / 316L
CL	Tri-clamp 1", PN 16, L, Ra < 0.8 µm
CN	Tri-clamp 2", PN 16, L, Ra < 0.8 µm
RL	Conical adapter DN 25, DIN 11851 with coupling nut PN 40 / 316L, Ra < 0.8 µm
RM	Conical adapter DN 40, DIN 11851 with coupling nut PN 40 / 316L, Ra < 0.8 µm
RN	Conical adapter DN 50, DIN 11851 with coupling nut PN 40 / 316L, Ra < 0.8 µm
R3	Thread R ¾, PN 64, 316L, EN10226-1
Electronics	

LFV230-XXSGATPM0220 | LFV200

VIBRATING LEVEL SWITCH

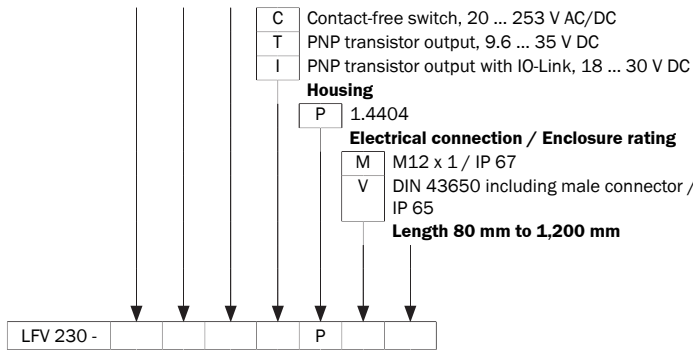

Not all variants of the type code can be combined!

[Dimensional drawing](#) (Dimensions in mm (inch))

Dimensional drawing process connection

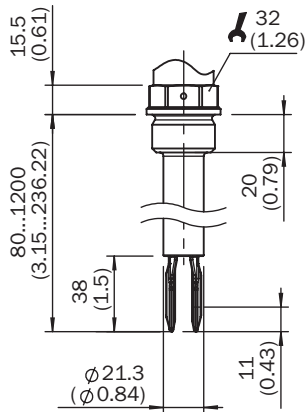

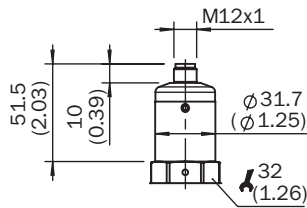

Dimensional drawing housing



Recommended accessories

Other models and accessories → www.sick.com/LFV200

	Brief description	Type	Part no.
Flanges			
	Welded flange/welded connector, DIN11851-1, DN25 / PN40, Stainless steel 1.4404	BEF-FL-851D25-LFV2	5321527
	Welded flange/welded connector DIN11851-1, DN40 / PN40, Stainless steel 1.4404	BEF-FL-851D40-LFV2	5321459
	Welded flange/welded connector DIN11851-1, DN50 / PN25, Stainless steel 1.4404	BEF-FL-851D50-LFV2	5321528
	Welded flange/welded connector, process connection G 1, Stainless steel 1.4404	BEF-FL-GEWG10-LFV2	4054605

	Brief description	Type	Part no.
	Welded flange/welded connector, G 3/4 process connection, Stainless steel 1.4404	BEF-FL-GEWG34-LFV2	4054604
	Welded flange/welded connector, process connection Tri-Clamp 1\", Stainless steel 1.4404	BEF-FL-TCLI10-LFV2	5321678
	Welded flange/welded connector, process connection Tri-Clamp 2\", Stainless steel 1.4404	BEF-FL-TCLI20-LFV2	5321679

SICK AT A GLANCE

SICK is one of the leading manufacturers of intelligent sensors and sensor solutions for industrial applications. A unique range of products and services creates the perfect basis for controlling processes securely and efficiently, protecting individuals from accidents and preventing damage to the environment.

We have extensive experience in a wide range of industries and understand their processes and requirements. With intelligent sensors, we can deliver exactly what our customers need. In application centers in Europe, Asia and North America, system solutions are tested and optimized in accordance with customer specifications. All this makes us a reliable supplier and development partner.

Comprehensive services complete our offering: SICK LifeTime Services provide support throughout the machine life cycle and ensure safety and productivity.

For us, that is “Sensor Intelligence.”

WORLDWIDE PRESENCE:

Contacts and other locations –www.sick.com