

INSTRUCTIONS DE MONTAGE

COFFRET MURAL

Profondeurs 450mm et 600mm



GAMMES ET DIMENSIONS

Les gammes de coffrets se décomposent en 2 catégories de profondeurs et 6 catégories de hauteur.

Gamme en profondeur 450mm

REFERENCES	CAPACITE en U	LARGEUR en mm	PROFONDEUR en mm	HAUTEUR en mm	NOMBRE DE COLIS
27 339	6 U	600 mm	450 mm	370	1
27 341	9 U			503	1
27 348	12 U			636	2
27 351	15 U			770	2
27 354	18 U			903	2
27 357	22 U			1082	2

Gamme en profondeur 600mm

REFERENCES	CAPACITE en U	LARGEUR en mm	PROFONDEUR en mm	HAUTEUR en mm	NOMBRE DE COLIS
27 340	6 U	600 mm	600 mm	370	1
27 343	9 U			503	1
27 349	12 U			636	2
27 352	15 U			770	2
27 355	18 U			903	2
27 358	22 U			1082	2

INVENTAIRE

Matériel



Plancher x1



Toit x1



Porte vitrée x1



Fond x1



Cadre latéral x2



Porte latéral x2



Equerre x4



Barre transversale x4



Comprend également :

3 serrures

3 jeux de clefs

1 système de fixation mural

Vis et écrous

	TAILLE DU COFFRET				
	6 U	9 U	12 U	15 U	18 U
Vis 6x12	28	28	28	32	32
Vis 5x8	18	18	18	18	18
Vis 3.5x6	10	10	10	10	10
Ecrou Cage	4	4	4	8	8

Toutes les vis et écrous nécessaires au montage sont fournis avec chaque coffret.

VUE ECLATÉE

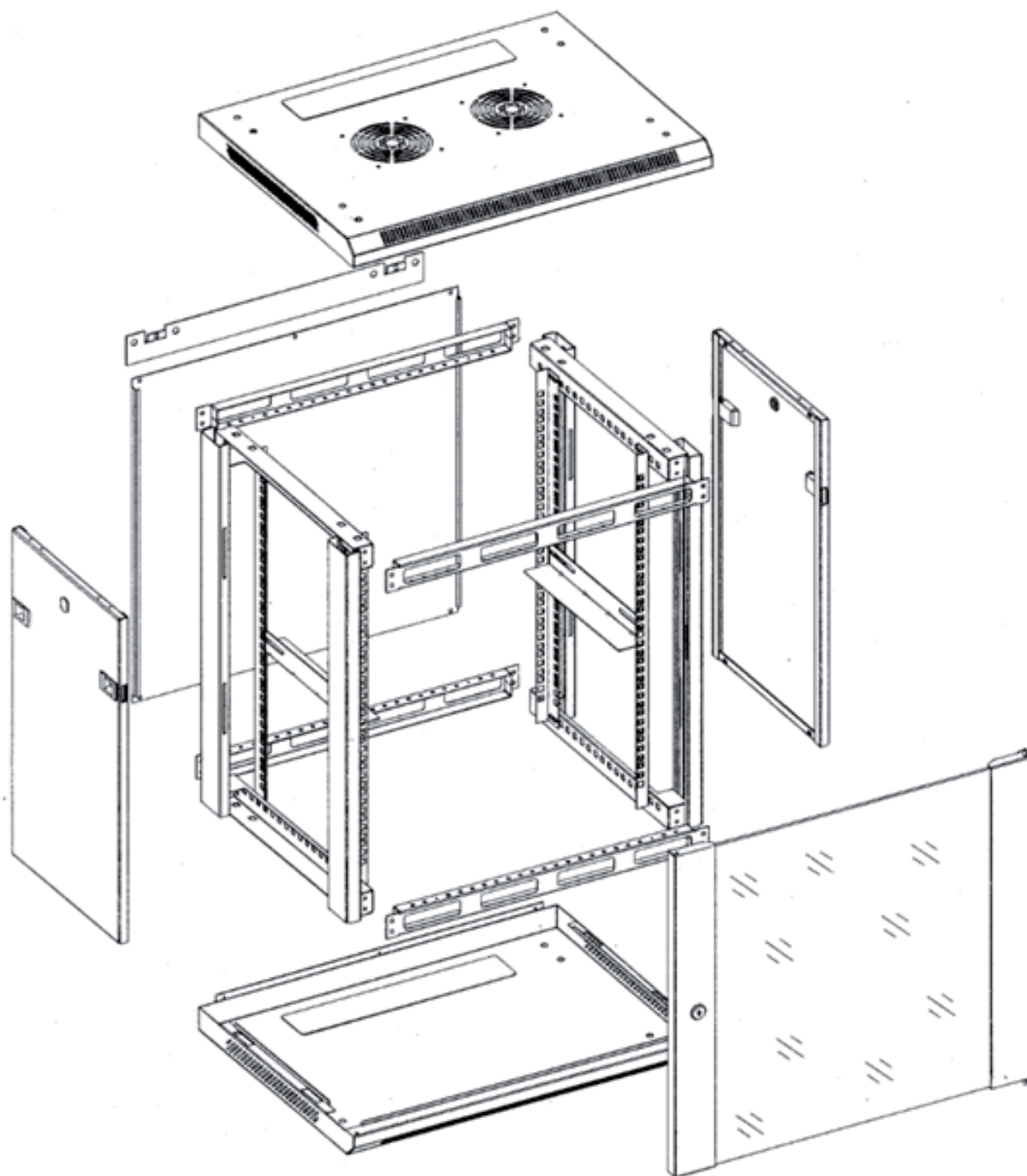

MONTAGE

01. Construire un cube en solidarifiant les deux cadres latéraux à l'aide des barres transversales.



+



+

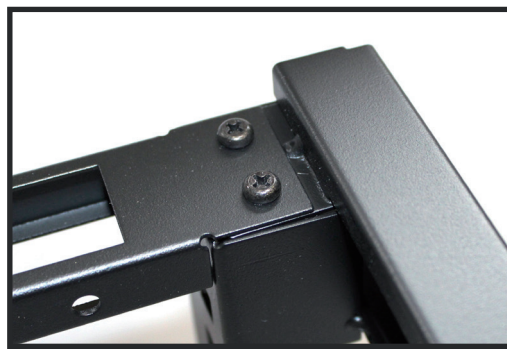
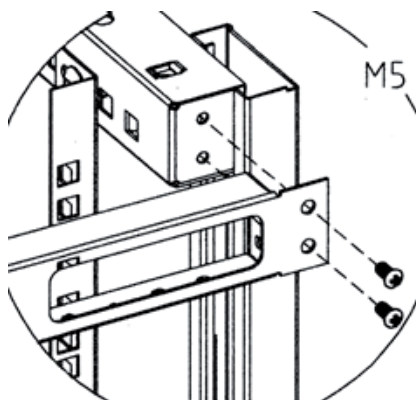

RÉSULTAT FINAL



02. Fixer les équerres sur les cadres latéraux puis fixer les rails si vous le souhaitez.
CONSEIL : Penser à orienter les chiffres inscrits sur les équerres vers l'extérieur.

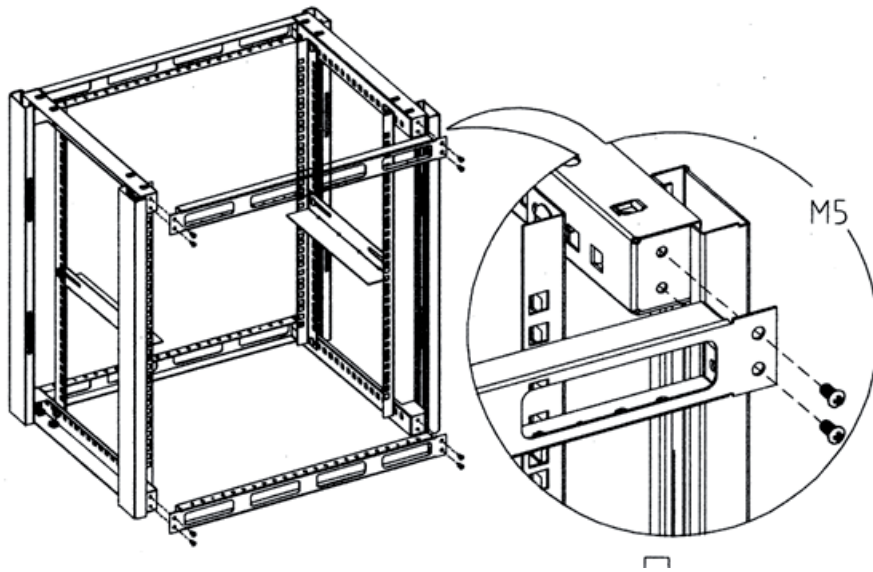
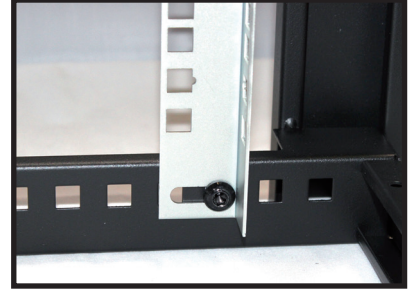
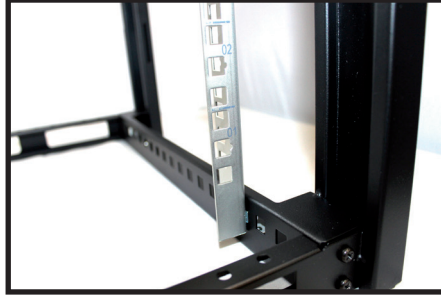
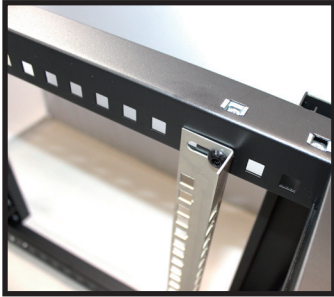

RÉSULTAT FINAL



03. Fixer le toit.

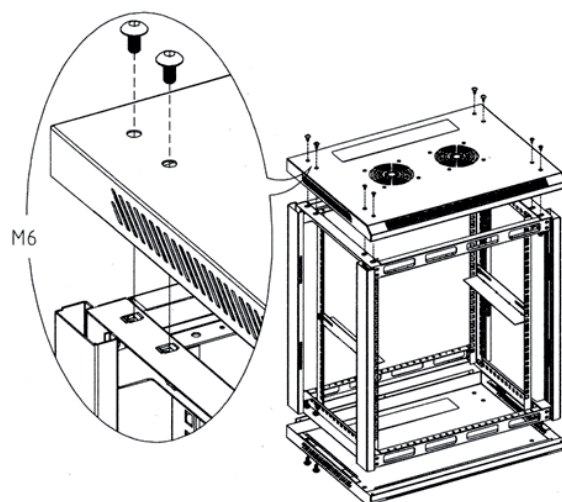

04. Fixer le plancher (processus identique au montage du toit).



RÉSULTAT FINAL

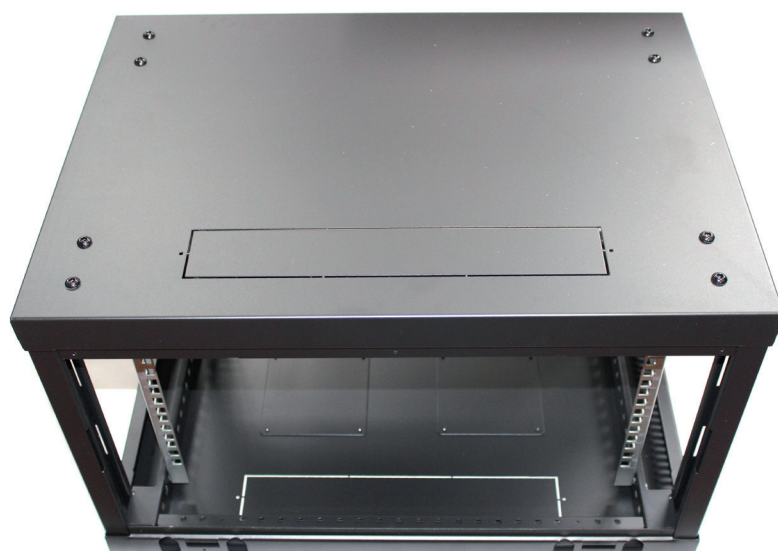

Fixer le fond.

05. CONSEIL : Pour faciliter la fixation du fond, pivoter le coffret sur le côté de façon à obtenir la configuration ci-dessous (voir photo).

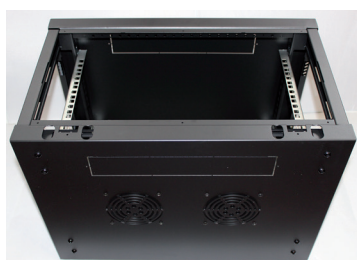
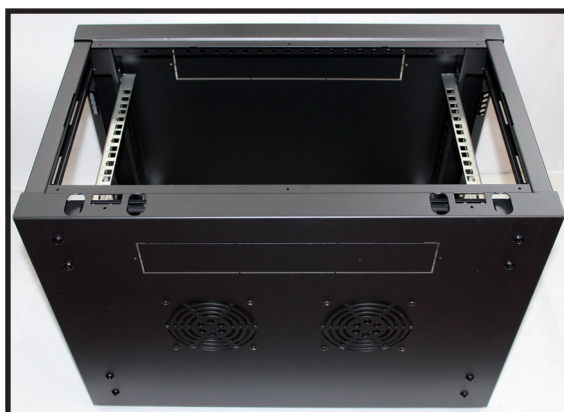

+



+

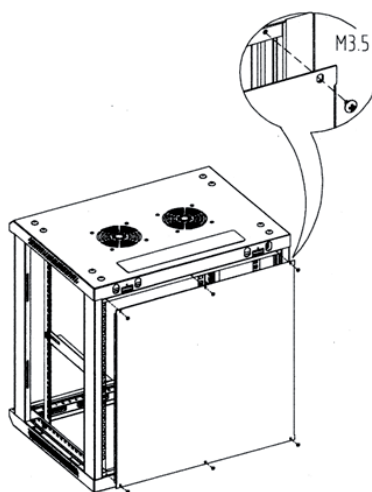

RÉSULTAT FINAL



Installer les portes latérales

06. CONSEIL : Pour faciliter l'installation, pivoter le coffret à l'endroit puis positionner le bas des portes dans les espaces prévus à cet effet (voir photo ci-dessous).

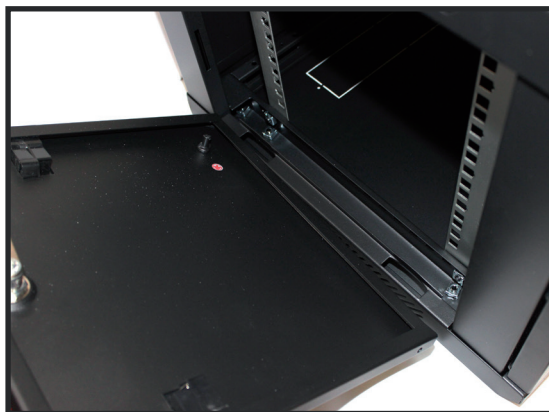

+



RÉSULTAT FINAL



Installer la porte vitrée

07.

CONSEIL : Dans un premier temps, mettre le téton du bas de la porte dans l'emplacement prévu à cet effet (voir photo 01).
Dans un second temps, encliquer le loquet de verrouillage en appuyant sur le ressort (voir photo 02).

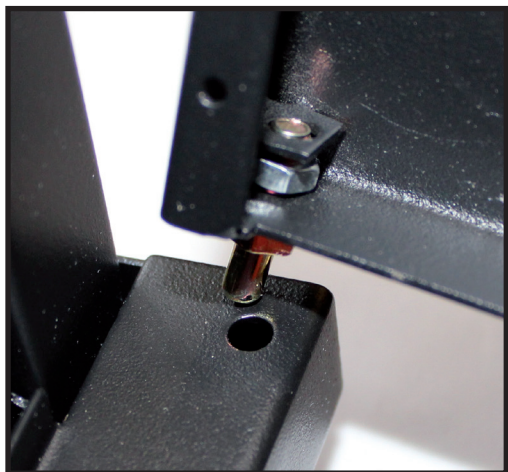

01

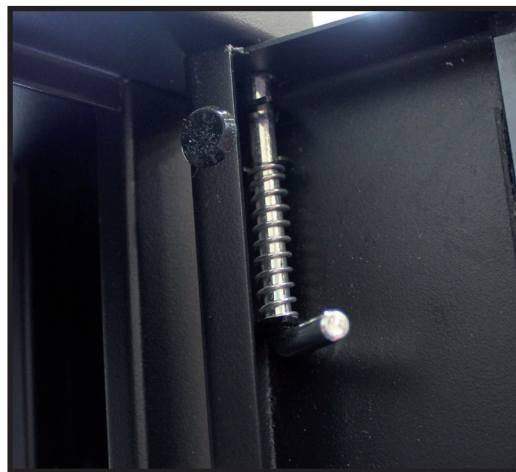

02



RÉSULTAT FINAL



08. Monter les serrures

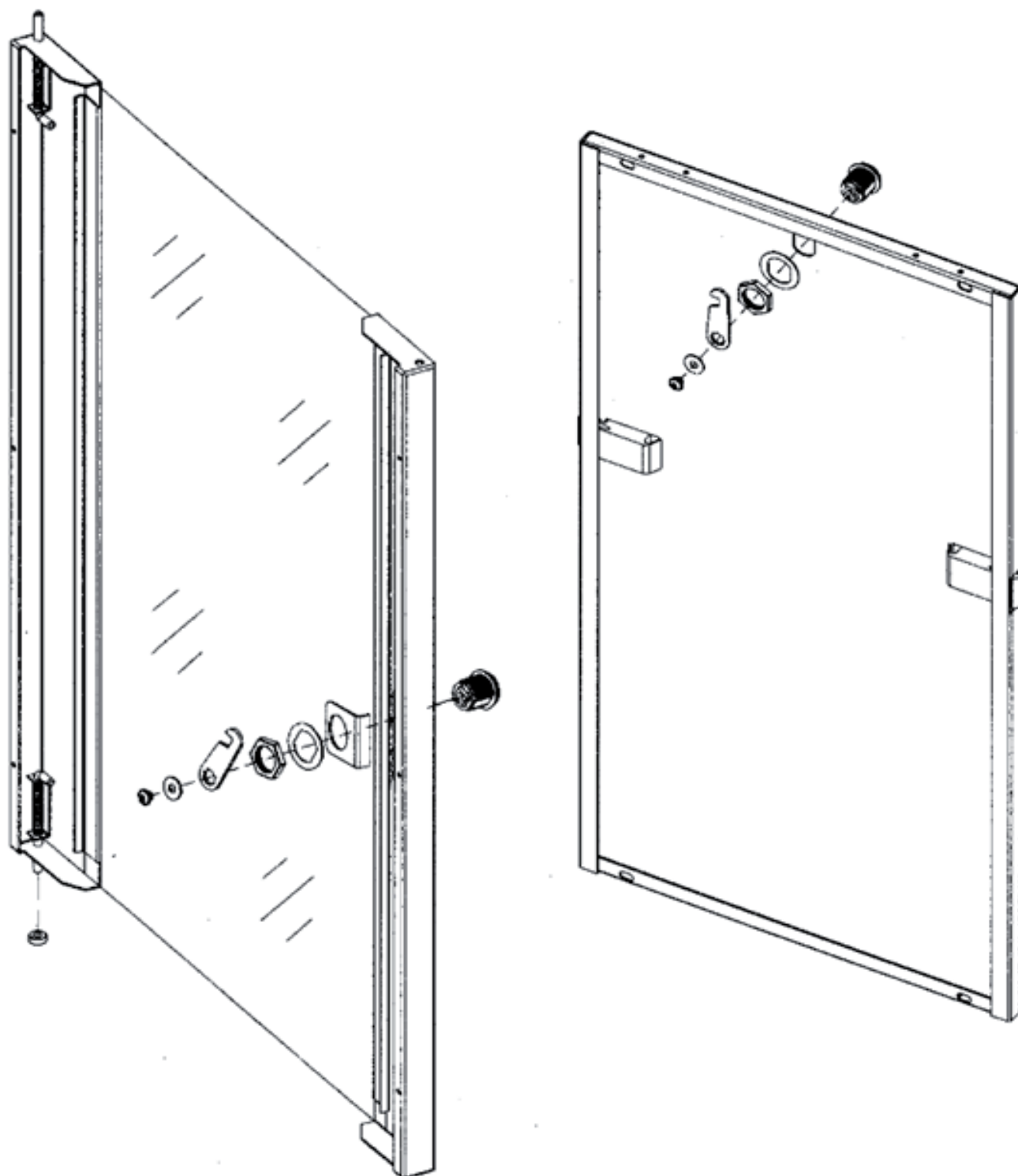

09. Votre coffret est à présent monté et prêt à l'emploi.



MONTAGE OPTIONNEL

Installation du coffret au mur

10. Fixer le support mural puis accrocher le coffret au mur.
Finissez l'installation en plaçant les panneaux latéraux et la porte avant.

