



Product designation	MINIATURE RELAYS		
Product type designation	HR301C		
Contact characteristics			
Contact configuration	1 C/O		
Rated insulation voltage U_i IEC/EN	V	250	
Rated impulse withstand voltage U_{imp}	kV	6	
IEC Conventional free air thermal current I_{th}	A	16	
Maximum instantaneous current	A	60	
Rated current (I_n)	A	16	
Relay control voltage	V	24VAC	
Max contrrollable power in			
	AC-1	W	4000
	AC-15	VA	300
Rated operating power AC-1		VA	4000
Rated operating power AC-15	230 VAC	VA	300
Single-phase motor control	230VAC	kW	0.4
Rated operating current DC-1			
	30V	A	12
	110V	A	0.3
	220V	A	0.1
Minimum switching load		V / mA	5 / 100
Contact impedance		m Ω	100
Contact material		AgSnO ₂	
Operating times			
Closing		ms	10
Opening		ms	5
Operations			
Mechanical life		cycles	10000000
Electrical life AC1		cycles	50000
Coil characteristics			
Average coil consumption AC at 20°C		VA	0.9
Average coil consumption DC at 20°C		W	0.45
Operating range			
	Closing	% U_n	70...110
	Opening	% U_n	20...55
Maximum cycle frequency		cycles/h	3600
Mechanical features			
Max socket terminal tightening torque		Nm	0.6
Socket screw tightening tool (cross / flat blade)		PH1 / 4.5mm	
Conductor section	AWG/Kcmil		

	min	20	
	max	14	
IEC			
	min	mm ²	0.5
	max	mm ²	2.5
Operating position	normal	Any	
Fixing	On 35mm DIN rail and with screw		

Ambient conditions

Temperature	Operating temperature		
	min	°C	-40
	max	°C	+85
	Storage temperature		
	min	°C	-40
	max	°C	+85

Other features

Indication	No
Mechanical contact position indicator	No
Mechanical test actuator	No

Dimensions

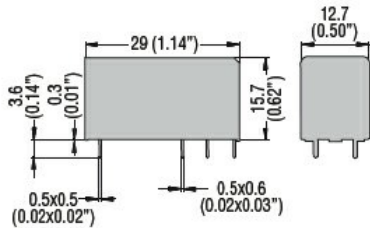

PCB layout

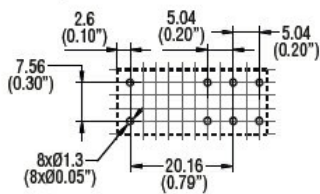

Wiring diagrams

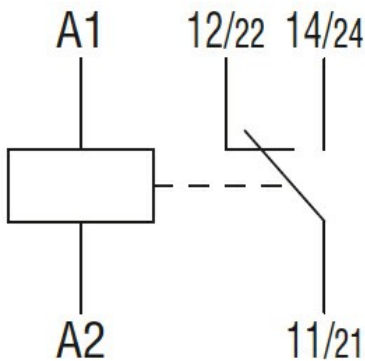

Certifications and compliance

Compliance	IEC/EN 61810
------------	--------------

Certificates

CSA

cURus

EAC

VDE

ETIM classification

ETIM 8.0

EC001437 -
Switching relay