

ARKOSLIGHT®



WIRE TRIMLESS
A C C E S S O R Y



WIRE TRIMLESS
ACCESSORY
SUSPENSION ACCESSORIES

WIRE TRIMLESS ACCESSORY

Wire Trimless Accessory est une collection d'accessoires qui permettent d'installer les tendeurs et les câbles des luminaires suspendus d'Arkoslight directement au plafond, sans rosette ni fixation apparente. Ceci permet d'obtenir une application minimaliste et visuellement propre dans l'espace.

Grâce aux Wire Trimless Accessory, les éléments adjacents au plafond du produit standard (rosette, fixation, boîtiers de *driver*...) sont dissimulés au moyen d'un montage encastré.

Wire Trimless Accessory réduit le poids visuel de l'installation et crée une esthétique extrêmement minimaliste. Les câbles émanent des éléments au plafond comme s'ils faisaient partie de la propre structure. Ce détail favorise une disposition beaucoup plus épurée et essentielle, notamment dans les compositions de plusieurs luminaires.



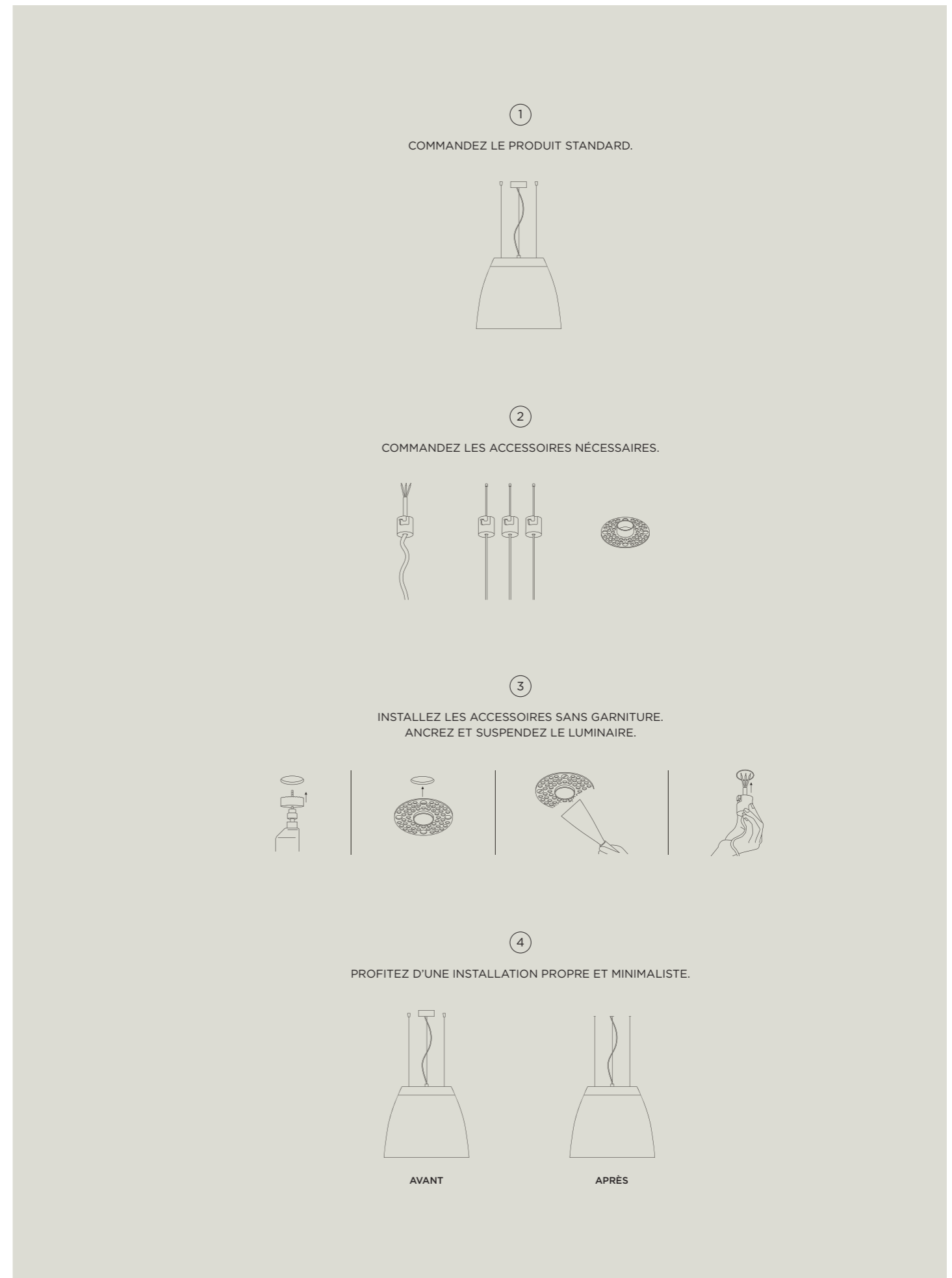

DISPONIBLE POUR :

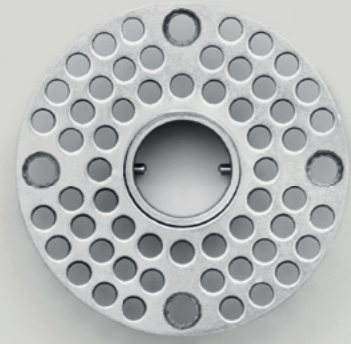

- (A) Mains Trimless
- (B) Mains Thick Trimless
- (C) Coaxial Trimless
- (D) Unipolar Trimless
- (E) Steel Cable Trimless
- (F) Steel Cable Regulator Trimless

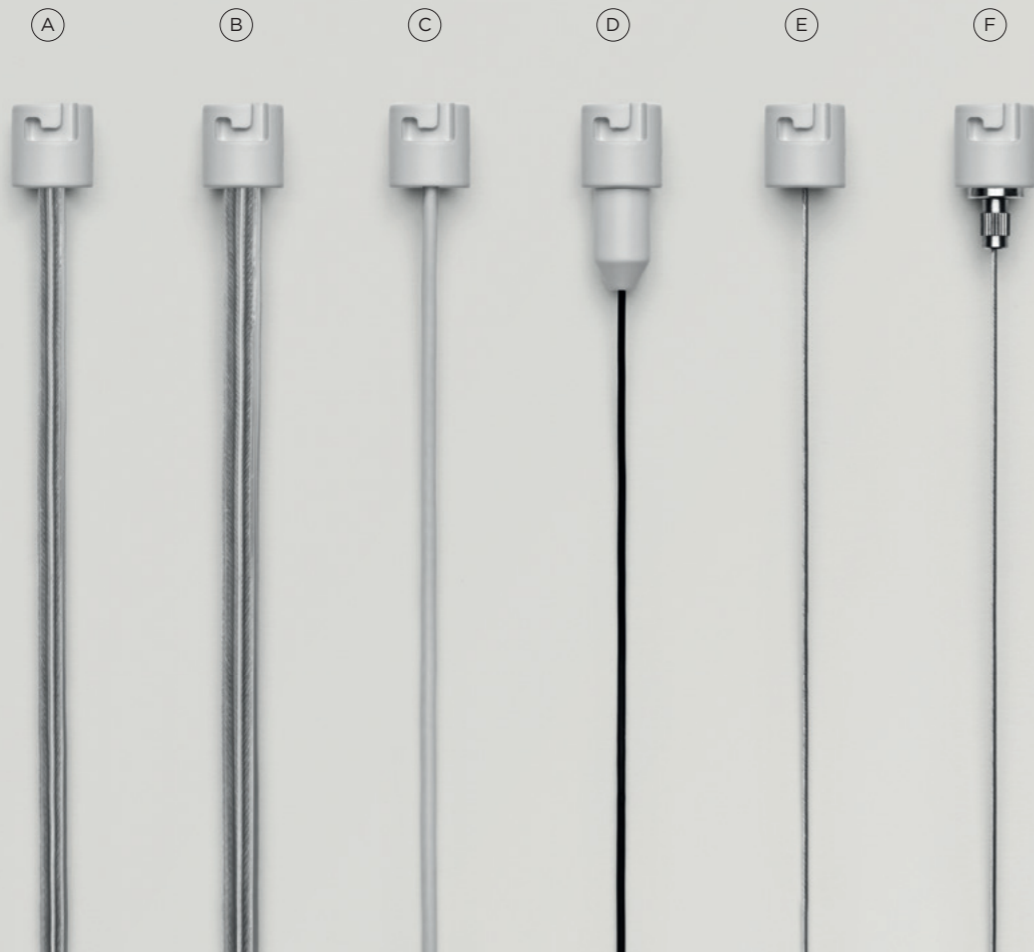

SALT



SCOPE



SALT MINI



TRACK 48V SUSPENSION



BLACK FOSTER SUSPENSION



HOLLY

SPIN



FIFTY SUSPENSION

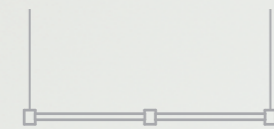

ART



DRUM SUSPENSION



MINIMAL TRACK



BRIGIT



SLIMGOT

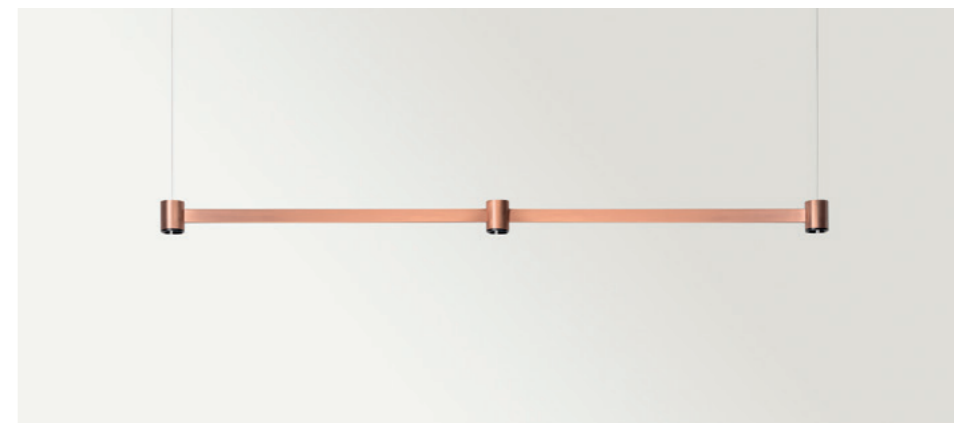

		P	CCT	I	Flux	LOR
ART	A342-00-10- WT NT BC BG	6,3W	2700K	700mA	570Lm	92%
	A342-00-11- WT NT BC BG	6,3W	3000K	700mA	630Lm	92%
	A342-00-20- WT NT BC BG	6,3W	2700K	700mA	570Lm	92%
	DALI* A342-00-21- WT NT BC BG	6,3W	3000K	700mA	630Lm	92%

LED | 220 V~ | CE | IP20 | CRI>90 | L80B10 >60.000h

MacAdam Step 3 | INCL | 2 X Ø50 | UGR<19 | 38°

FINISHING**

Lamp	Base
WT <input type="checkbox"/>	WT <input type="checkbox"/>
NT <input type="checkbox"/>	NT <input type="checkbox"/>
BC <input type="checkbox"/>	WT <input type="checkbox"/>
BG <input type="checkbox"/>	WT <input type="checkbox"/>

BASE NOT USED WITH WIRE TRIMLESS INSTALLATION.

WIRE TRIMLESS ACCESSORY

UNIPOLAR TRIMLESS A023-00-04- | W | N |

2 Pcs. needed

REMOTE | INCL | Ø20

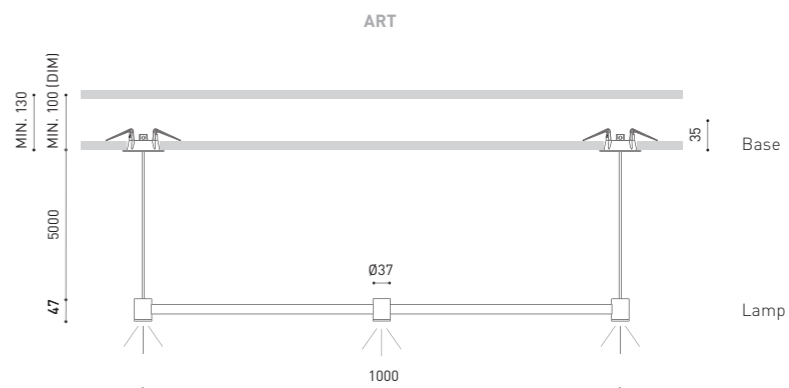
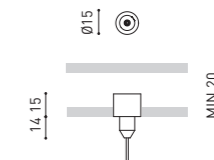

UNIPOLAR TRIMLESS

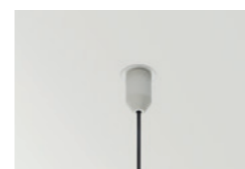

COLOUR | WT RAL 9016 | NT RAL 9005 | BC | BG | MATERIAL | BR | ABS+PC | » 42

OTHER CCT | * OTHER DIM OPTIONS | ** OTHER FINISHING COMBINATIONS » PLEASE CONSULT

» PLEASE CONSULT



Arkosight Headquarters, Valencia (Spain) | Design: Francesc Rifé Studio | Architect: Victor Garcia Martínez Arquitecto | Photography: Héctor Rubio - Images Positive

UNIPOLAR TRIMLESS

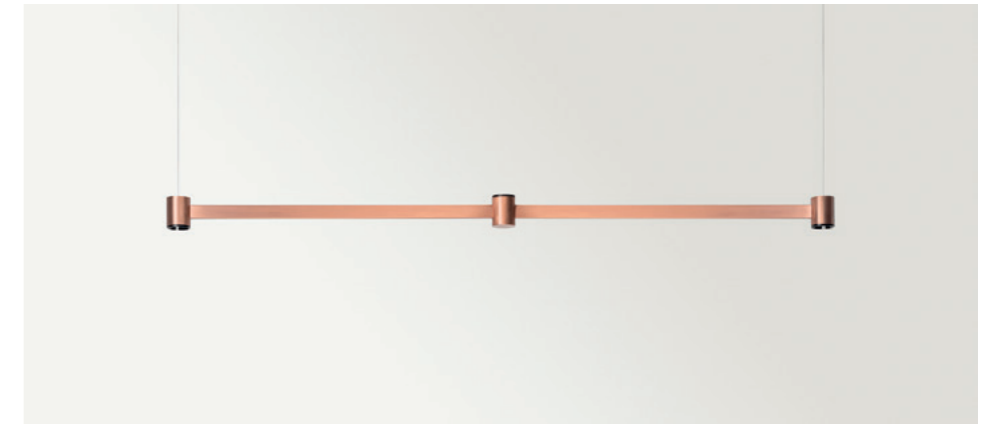
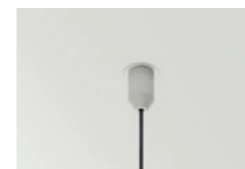

		P	CCT	I	Flux	LOR
ART	A343-00-10- WT NT BC BG	6,3W	2700K	700mA	570Lm	92%
Direct & Indirect	A343-00-11- WT NT BC BG	6,3W	3000K	700mA	630Lm	92%
	A343-00-20- WT NT BC BG	6,3W	2700K	700mA	570Lm	92%
	DALI* A343-00-21- WT NT BC BG	6,3W	3000K	700mA	630Lm	92%

LED | 220 V~ | CE | IP20 | CRI>90 | L80B10 > 60.000h



FINISHING**	Lamp	Base
	WT <input type="checkbox"/>	WT <input type="checkbox"/>
	NT <input type="checkbox"/>	NT <input type="checkbox"/>
	BC <input type="checkbox"/>	WT <input type="checkbox"/>
	BG <input type="checkbox"/>	WT <input type="checkbox"/>

BASE NOT USED WITH WIRE TRIMLESS INSTALLATION.

WIRE TRIMLESS ACCESSORY

UNIPOLAR TRIMLESS A023-00-04- | W | N |

2 Pcs. needed

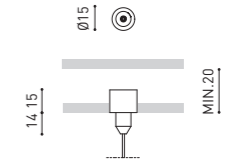

ART DIRECT & INDIRECT

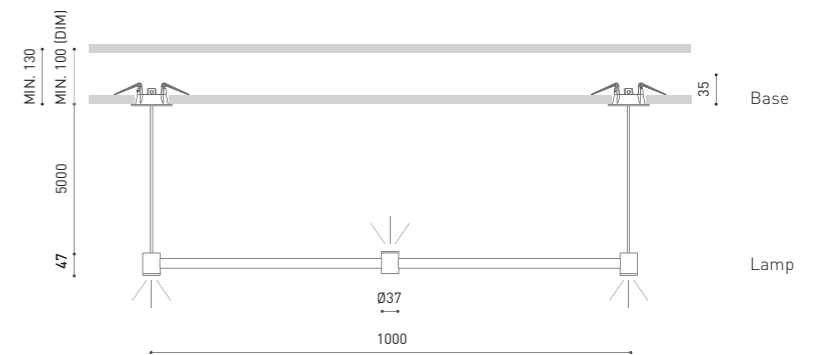

COLOUR | WT RAL 9016 | NT RAL 9005 | BC | BG | MATERIAL | BR | ABS+PC | » 42

OTHER CCT | * OTHER DIM OPTIONS | ** OTHER FINISHING COMBINATIONS » PLEASE CONSULT

» PLEASE CONSULT

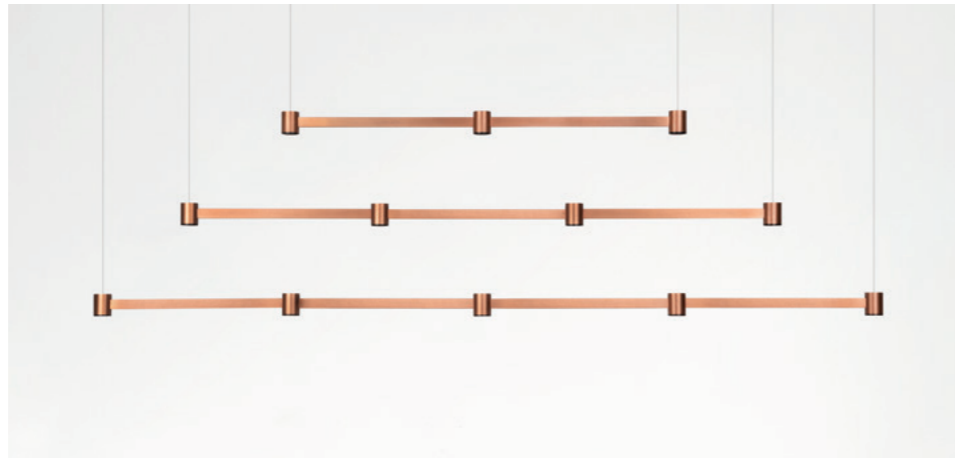

	P	CCT	I	Flux	LOR	
ART Modular 3	WT NT BC BG	6,3W	2700K	700mA	570Lm	92%
	WT NT BC BG	6,3W	3000K	700mA	630Lm	92%
	DALI* WT NT BC BG	6,3W	2700K	700mA	570Lm	92%
	DALI* WT NT BC BG	6,3W	3000K	700mA	630Lm	92%
ART Modular 4	WT NT BC BG	8,4W	2700K	700mA	760Lm	92%
	WT NT BC BG	8,4W	3000K	700mA	840Lm	92%
	DALI* WT NT BC BG	8,4W	2700K	700mA	760Lm	92%
	DALI* WT NT BC BG	8,4W	3000K	700mA	840Lm	92%
ART Modular 5	WT NT BC BG	10,5W	2700K	700mA	950Lm	92%
	WT NT BC BG	10,5W	3000K	700mA	1050Lm	92%
	DALI* WT NT BC BG	10,5W	2700K	700mA	950Lm	92%
	DALI* WT NT BC BG	10,5W	3000K	700mA	1050Lm	92%

LED | 220-240 V~ | CE | IP20 | CRI>90 | L80B10 > 60.000h



FINISHING**	Lamp	Base
	WT □	WT □
	NT ■	NT ■
	BC ■	WT □
	BG ■	WT □

BASE NOT USED WITH WIRE TRIMLESS INSTALLATION.

WIRE TRIMLESS ACCESSORY

UNIPOLAR TRIMLESS A023-00-04- | W | N |

2 Pcs. needed

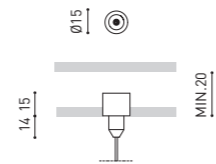

COLOUR | WT □ RAL 9016 | NT ■ RAL 9005 | BC ■ | BG ■ | MATERIAL | BR | ABS+PC | ⓘ » 42

OTHER CCT | * OTHER DIM OPTIONS | ** OTHER FINISHING COMBINATIONS » PLEASE CONSULT

» PLEASE CONSULT

UNIPOLAR TRIMLESS

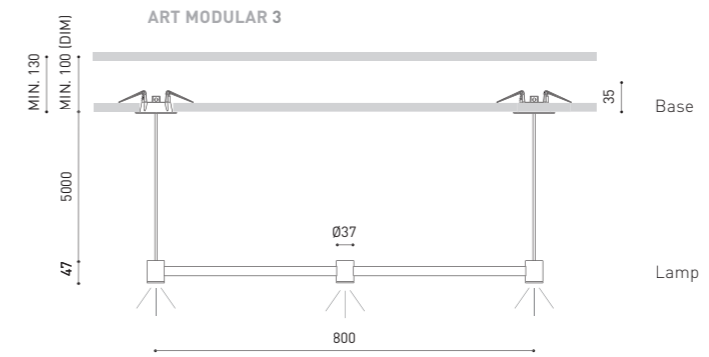
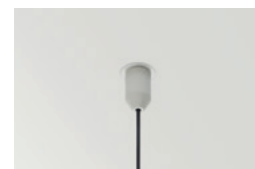

ATTENTION

Art Modular '3' a une longueur de 800 mm. Les versions préexistantes de l'ART mesurent 1000 mm de long.

Direct & Indirect Option

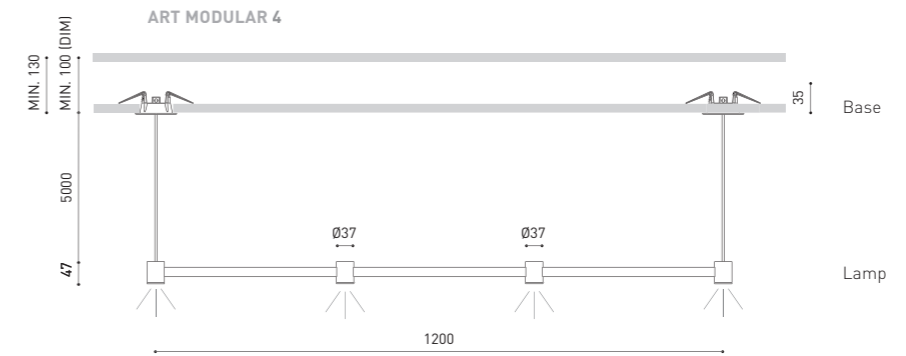

Direct & Indirect Option

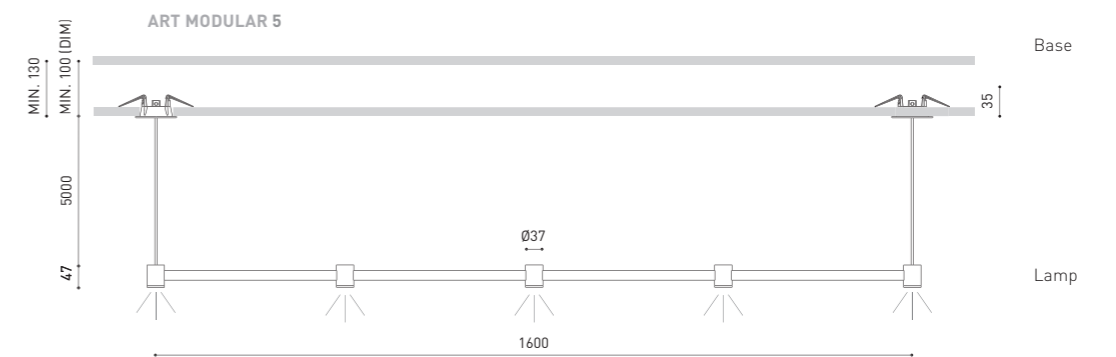

Direct & Indirect Options

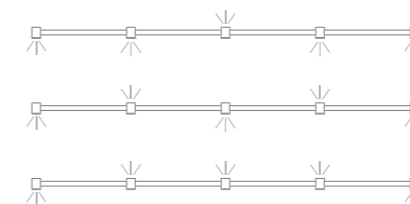

HOLLY



		P	CCT	Beam	I	Flux	LOR
HOLLY	A281- Ⓞ -0-00- WT NT MC MG	2,1W	2700K	19°	700mA	190Lm	90%
	A281- Ⓞ -0-01- WT NT MC MG	2,1W	3000K	19°	700mA	210Lm	90%
	A281- Ⓞ -0-10- WT NT MC MG	2,1W	2700K	38°	700mA	190Lm	92%
	A281- Ⓞ -0-11- WT NT MC MG	2,1W	3000K	38°	700mA	210Lm	92%

LED | 220-240 V~ | CE | IP20 | CRI>90 | L80B10 >60.000h



Ⓞ	SUSPENSION DISTANCE-L
0	2 m
1	3 m
2	5 m

FINISHING **	Lamp	Base
WT	WT □ W □	
NT	NT ■ N ■	
MC	MC ■ N ■	
MG	MG ■ N ■	

BASE NOT USED WITH WIRE TRIMLESS INSTALLATION.

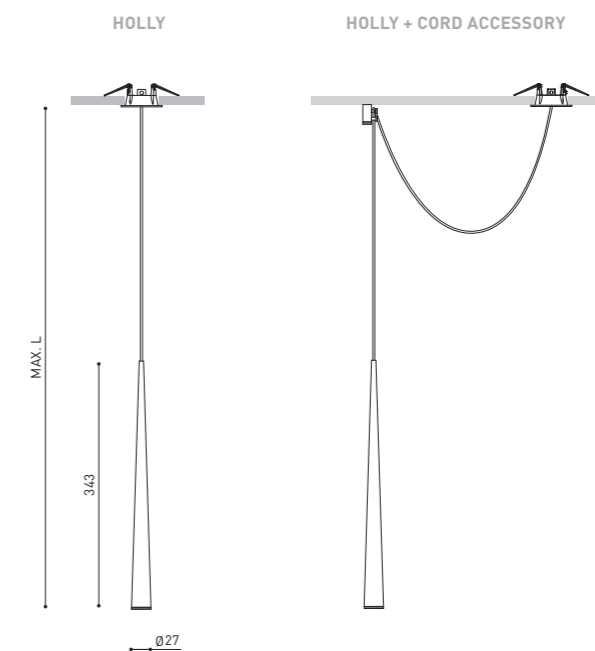

HOLLY Cord Accessory
0223-00-00- | WT | NT |

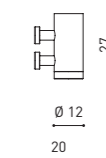

CORD ACCESSORY



COAXIAL TRIMLESS

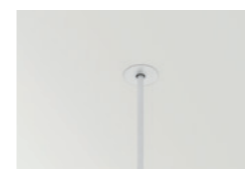

WIRE TRIMLESS ACCESSORY

COAXIAL TRIMLESS

A023-00-03- | W | N |

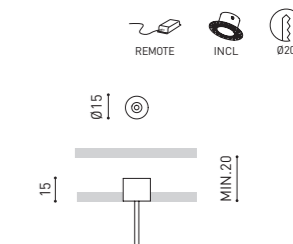

COLOUR | WT □ RAL 9016 | NT ■ RAL 9005 | MC ■ | MG ■ | MATERIAL | AL | ABS | ⓘ » 42

* DIM OPTIONS PLEASE CONSULT | ** OTHER FINISHING COMBINATIONS PLEASE CONSULT

» PLEASE CONSULT

SPIN



		P	CCT	Beam	I	Flux	LOR
SPIN	A222- Ⓞ -2-01- WT NT MC MG	6,5W	2700K	24°	700mA	600Lm	86%
	A222- Ⓞ -2-01- WT NT MC MG	6,5W	3000K	24°	700mA	630Lm	86%
	A222- Ⓞ -2-02- WT NT MC MG	6,5W	4000K	24°	700mA	680Lm	86%
	A222- Ⓞ -2-11- WT NT MC MG	6,5W	2700K	40°	700mA	630Lm	84%
	A222- Ⓞ -2-11- WT NT MC MG	6,5W	3000K	40°	700mA	630Lm	84%
	A222- Ⓞ -2-12- WT NT MC MG	6,5W	4000K	40°	700mA	680Lm	84%

LED | 220/240 V~ | CE | IP20 | CRI>90 | L80B10 >60.000h | MacAdam Step 2 | PHASE CUT* | INCL | Ø50 | 24°/40°

		P	CCT	Beam	I	Flux	LOR
SPIN Base	A221- Ⓞ -2-01- WT NT MC MG	6,5W	2700K	24°	700mA	600Lm	86%
	A221- Ⓞ -2-01- WT NT MC MG	6,5W	3000K	24°	700mA	630Lm	86%
	A221- Ⓞ -2-02- WT NT MC MG	6,5W	4000K	24°	700mA	680Lm	86%
	A221- Ⓞ -2-11- WT NT MC MG	6,5W	2700K	40°	700mA	630Lm	84%
	A221- Ⓞ -2-11- WT NT MC MG	6,5W	3000K	40°	700mA	630Lm	84%
	A221- Ⓞ -2-12- WT NT MC MG	6,5W	4000K	40°	700mA	680Lm	84%

LED | 220/240 V~ | CE | IP20 | CRI>90 | L80B10 >60.000h | MacAdam Step 2 | PHASE CUT* | INCL | 24°/40°

Ⓞ	SUSPENSION DISTANCE-L
0	2 m
1	3 m
2	5 m

SPIN Cord Accessory

0223-00-00- | WT | NT |

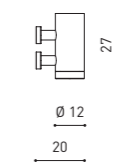

FINISHING **	Lamp	Base
WT	WT <input type="checkbox"/>	W <input type="checkbox"/>
NT	NT <input type="checkbox"/>	N <input type="checkbox"/>
MC	MC <input type="checkbox"/>	N <input type="checkbox"/>
MG	MG <input type="checkbox"/>	N <input type="checkbox"/>

BASE NOT USED WITH WIRE TRIMLESS INSTALLATION.

CORD ACCESSORY



COAXIAL TRIMLESS

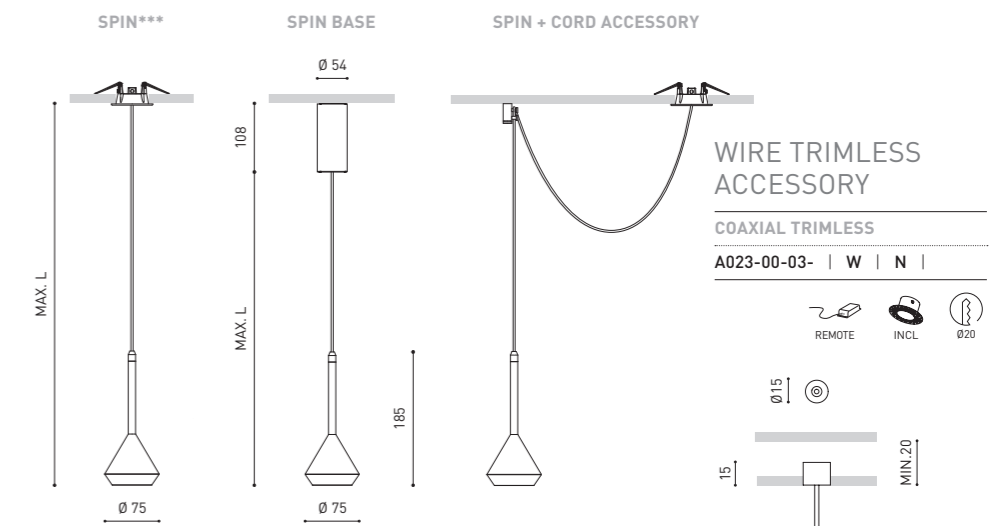
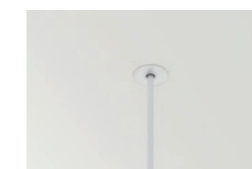

COLOUR | WT RAL 9016 | NT RAL 9005 | MC MG | MATERIAL | AL | PMMA | i » 42

* DIM OPTIONS PLEASE CONSULT | ** OTHER FINISHING COMBINATIONS PLEASE CONSULT

*** SUGGESTED FOR WIRE TRIMLESS INSTALLATION

⌘ » PLEASE CONSULT

WIRE TRIMLESS ACCESSORY

SCOPE



		P	CCT	I	Flux	LOR	
SCOPE 35	A261-30-00-	WW WG WR NN NG	7W	2700K	200mA	910Lm	89%
	A261-30-01-	WW WG WR NN NG	7W	3000K	200mA	940Lm	89%
	A261-30-02-	WW WG WR NN NG	7W	4000K	200mA	960Lm	89%

220-240V~ |
 CE |
 IP20 |
 CRI>90 |
 L80B10 >60,000h |
 MacAdam Step 2 |
 PHASE CUT |
 INCL |
 2m |
 FAST |
 47°

		P	CCT	I	Flux	LOR	
SCOPE 27	A261-20-00-	WW WG WR NN NG	7W	2700K	200mA	910Lm	89%
	A261-20-01-	WW WG WR NN NG	7W	3000K	200mA	940Lm	89%
	A261-20-02-	WW WG WR NN NG	7W	4000K	200mA	960Lm	89%

220-240V~ |
 CE |
 IP20 |
 CRI>90 |
 L80B10 >60,000h |
 MacAdam Step 2 |
 PHASE CUT |
 INCL |
 2m |
 FAST |
 47°

		P	CCT	I	Flux	LOR	
SCOPE 21	A261-10-00-	WW WG WR NN NG	7W	2700K	200mA	910Lm	89%
	A261-10-01-	WW WG WR NN NG	7W	3000K	200mA	940Lm	89%
	A261-10-02-	WW WG WR NN NG	7W	4000K	200mA	960Lm	89%

220-240V~ |
 CE |
 IP20 |
 CRI>90 |
 L80B10 >60,000h |
 MacAdam Step 2 |
 INCL |
 2m |
 FAST |
 47°

WIRE TRIMLESS ACCESSORIES

FEED
 MAINS TRIMLESS A023-00-01- | W | N |



FASTENING
 STEEL CABLE REGULATOR TRIMLESS

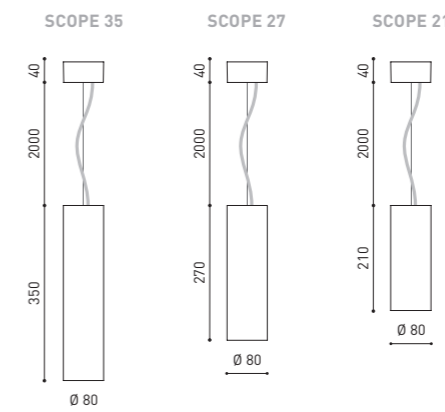
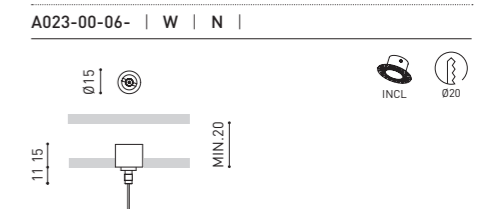

MAINS TRIMLESS

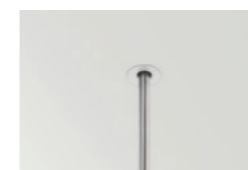

STEEL CABLE REGULATOR TRIMLESS

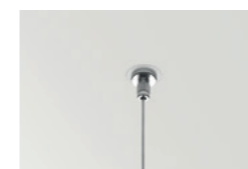

COLOUR | WW | WG | WR | NN | NG | MATERIAL | AL | PC | RAL » 42

OTHER COLOURS PLEASE CONSULT | COLOURS MAY AFFECT THE LIGHTING PARAMETERS

» PLEASE CONSULT

WIRE TRIMLESS ACCESSORY

SALT



		P	CCT	I	Flux	LOR
SALT 3	A220-03- 1 -1- WW WG WR NW NG NR	22W	3000K	700mA	3025Lm	79%
	A220-03- 1 -2- WW WG WR NW NG NR	22W	4000K	700mA	3075Lm	79%
SALT 4	A220-04- ② -1- WW WG WR NW NG NR	27W	3000K	700mA	4100Lm	79%
	A220-04- ② -2- WW WG WR NW NG NR	27W	4000K	700mA	4175Lm	79%
SALT 5	A220-05- ② -1- WW WG WR NW NG NR	35W	3000K	900mA	5125Lm	79%
	A220-05- ② -2- WW WG WR NW NG NR	35W	4000K	900mA	5225Lm	79%
SALT 6	A220-06- ② -1- WW WG WR NW NG NR	47,5W	3000K	1200mA	6550Lm	79%
	A220-06- ② -2- WW WG WR NW NG NR	47,5W	4000K	1200mA	6650Lm	79%

LED | 220-240 V~ | CE | IP20 | CRI>90 | L80B10 >60.000h

MacAdam Step 2 | OPTIONS* | INCL | 2m | FAST | 77°

		P	CCT	I	Flux	LOR
SALT PC 3	A220-03- 1 -1- TW TN	22W	3000K	700mA	3025Lm	84%
	A220-03- 1 -2- TW TN	22W	4000K	700mA	3075Lm	84%
SALT PC 4	A220-04- ② -1- TW TN	27W	3000K	700mA	4100Lm	84%
	A220-04- ② -2- TW TN	27W	4000K	700mA	4175Lm	84%
SALT PC 5	A220-05- ② -1- TW TN	35W	3000K	900mA	5125Lm	84%
	A220-05- ② -2- TW TN	35W	4000K	900mA	5225Lm	84%
SALT PC 6	A220-06- ② -1- TW TN	47,5W	3000K	1200mA	6550Lm	84%
	A220-06- ② -2- TW TN	47,5W	4000K	1200mA	6650Lm	84%

LED | 220-240 V~ | CE | IP20 | CRI>90 | L80B10 >60.000h

MacAdam Step 2 | OPTIONS* | INCL | 2m | FAST | 91°

② *OPTIONS

2	DIM Push
4	DIM DALI

WIRE TRIMLESS ACCESSORIES

FEED

MAINS TRIMLESS

A023-00-01- | W | N | NO DIM

MAINS THICK TRIMLESS

A023-00-02- | W | N | DIM

Ø15 | 15 | MIN.35 | REMOTE | INCL | Ø20

SALT & SALT PC

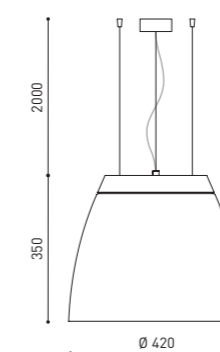

FASTENING

STEEL CABLE TRIMLESS

A023-00-05- | W | N | 3 Pcs. needed

Ø15 | 15 | MIN.20 | INCL | Ø20

COLOUR | WW □ | WG □ | WR □ | NW □ | NG □ | NR □ | MATERIAL | AL | PMMA | RAL ⓘ » 42

COLOUR | TW □ | TN □ | MATERIAL | AL | PC | PMMA | ⓘ » PLEASE CONSULT



	P	CCT	I	Flux	LOR
SALT Mini A280-00-11- WW WG WR NW NG NR	10W	3000K	700mA	1400Lm	67%
A280-00-12- WW WG WR NW NG NR	10W	4000K	700mA	1425Lm	67%

LED | 220-240V~ | CE | IP20 | CRI>90 | L80B10 >40.000h



WIRE TRIMLESS ACCESSORIES

FEED
MAINS TRIMLESS A023-00-01- | W | N |

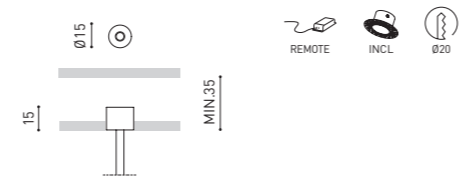

FASTENING
STEEL CABLE TRIMLESS A023-00-05- | W | N |
3 Pcs. needed

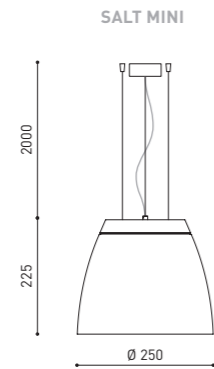
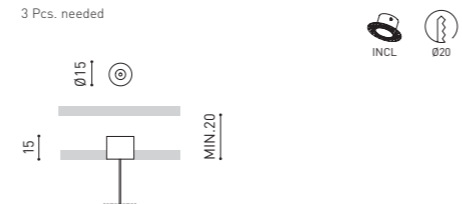

MAINS TRIMLESS

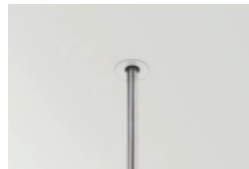

STEEL CABLE TRIMLESS

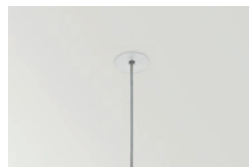

COLOUR | WW | WG | WR | NW | NG | NR | MATERIAL | AL | PMMA | RAL i » 42

COLOURS MAY AFFECT THE LIGHTING PARAMETERS

» PLEASE CONSULT



BRIGIT



		P	CCT	I	Flux	LOR
BRIGIT LED	0900-60-01- W	27W	3000K	700mA	4100Lm	88%
	0900-60-02- W	27W	4000K	700mA	4175Lm	88%
	0900-60-01- O	27W	3000K	700mA	4100Lm	42%
	0900-60-02- O	27W	4000K	700mA	4175Lm	42%
	0900-60-01- R	27W	3000K	700mA	4100Lm	30%
	0900-60-02- R	27W	4000K	700mA	4175Lm	30%

LED | 220-240 V~ | CE | IP44 | CRI>90 | L80B10 >60.000h



BRIGIT White



BRIGIT Orange



BRIGIT Red

WIRE TRIMLESS ACCESSORIES

FEED

MAINS THICK TRIMLESS A023-00-02- | W | N |

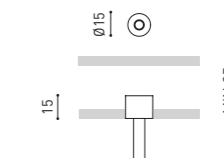

FASTENING

STEEL CABLE TRIMLESS A023-00-05- | W | N |

4 Pcs. needed

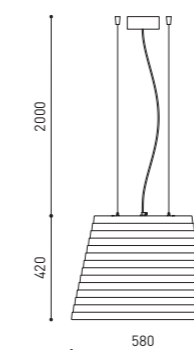
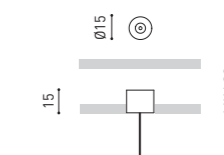

MAINS THICK TRIMLESS

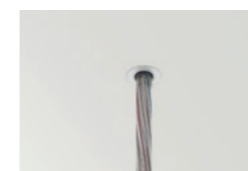

STEEL CABLE TRIMLESS

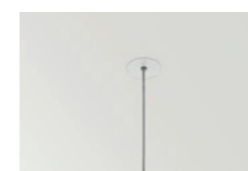

COLOUR | W | O | R | MATERIAL | PE | PC

RAL ⓘ » 42

» PLEASE CONSULT

DRUM



MAINS THICK TRIMLESS

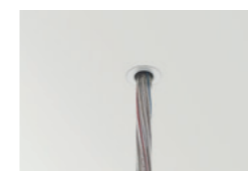

STEEL CABLE TRIMLESS

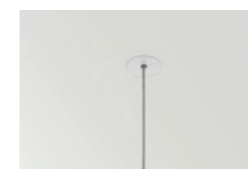

		P	CCT	I	Flux	LOR
DRUM 90	A358-20- -1- WT NT	119W	3000K	700mA	16100Lm	87%
Suspension	A358-20- -2- WT NT	119W	4000K	700mA	16350Lm	87%

| 220 V~ | | | CRI>90 | L80B10 >60.000h | | | | 2m | |

		P	CCT	I	Flux	LOR
DRUM 70	A358-10- -1- WT NT	59,5W	3000K	700mA	8050Lm	87%
Suspension	A358-10- -2- WT NT	59,5W	4000K	700mA	8175Lm	87%

| 220 V~ | | | CRI>90 | L80B10 >60.000h | | | | 2m | |

*OPTIONS

2	DIM DALI
3	DIM 1-10 V

WIRE TRIMLESS ACCESSORIES

FEED

MAINS THICK TRIMLESS

A023-00-02- | W | N |

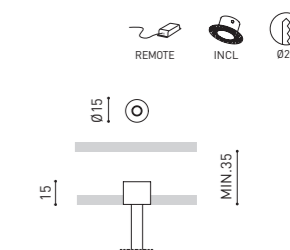

FASTENING

STEEL CABLE TRIMLESS

A023-00-05- | W | N |

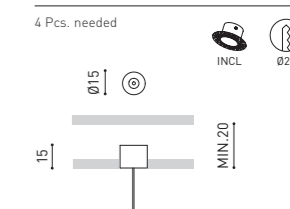

DRUM 90 SUSPENSION

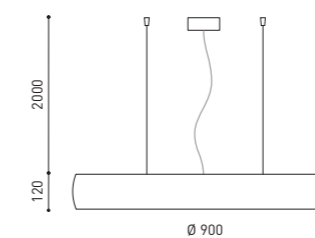
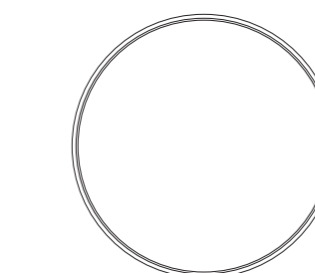

DRUM 70 SUSPENSION

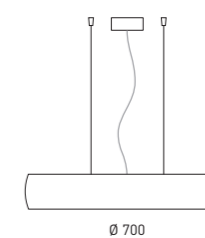
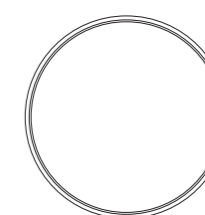

COLOUR | WT RAL 9016 | NT RAL 9005 | MATERIAL | AL | PMMA |

» 42

» PLEASE CONSULT

BLACK FOSTER SUSPENSION



○	BEAM	LOR
0	38°	92%
1	19°	90%

⊗	*OPTIONS
1	No DIM
2	DIM DALI
3	DIM Push
5	DIM On Board

MAINS TRIMLESS

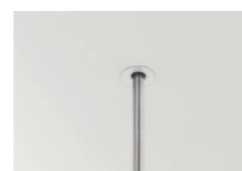

MAINS THICK TRIMLESS

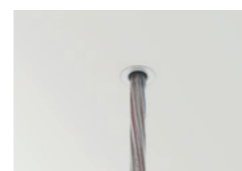

STEEL CABLE TRIMLESS

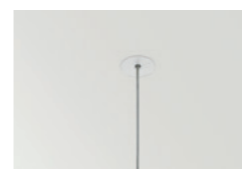

		P	CCT	I	Flux
BLACK FOSTER Suspension 1200	A321-1- ○ - ⊗ -0- WT NT WTMG NTMG	21W	2700K	700mA	1900Lm
	A321-1- ○ - ⊗ -1- WT NT WTMG NTMG	21W	3000K	700mA	2100Lm
	A321-1- ○ - ⊗ -2- WT NT WTMG NTMG	21W	4000K	700mA	2500Lm
BLACK FOSTER Suspension 1600	A321-2- ○ - ⊗ -0- WT NT WTMG NTMG	31,5W	2700K	700mA	2850Lm
	A321-2- ○ - ⊗ -1- WT NT WTMG NTMG	31,5W	3000K	700mA	3150Lm
	A321-2- ○ - ⊗ -2- WT NT WTMG NTMG	31,5W	4000K	700mA	3750Lm

LED | 220-240 V~ | CE | IP20 | CRI>90 | L80B10 >60.000h | MacAdam Step 3 | INCL | OPTIONS* | CABLE | 2 m | FAST | UGR<19 | 38° / 19°

WIRE TRIMLESS ACCESSORIES

FEED

MAINS TRIMLESS

A023-00-01- | W | N | NO DIM

MAINS THICK TRIMLESS

A023-00-02- | W | N | DIM

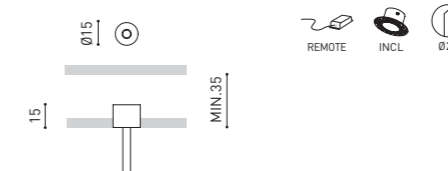

FASTENING

STEEL CABLE TRIMLESS

A023-00-05- | W | N | 2 Pcs. needed INCL Ø20

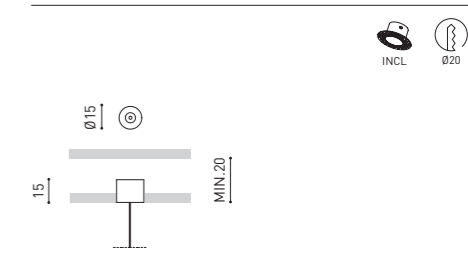

BLACK FOSTER SUSPENSION 1200

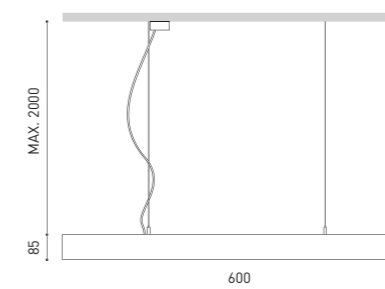

BLACK FOSTER SUSPENSION 1600

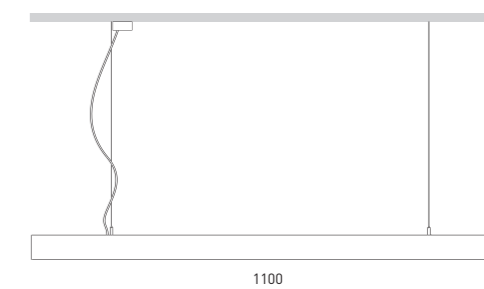

COLOUR | WT RAL 9016 | NT RAL 9005 | WTMG | NTMG | MATERIAL | AL | ABS+PC | » 42

TO ACHIEVE A HOMOGENEOUS LIGHT DISTRIBUTION, A DISTANCE OF 80 CM BETWEEN THE LUMINAIRE AND THE WORK SURFACE IS RECOMMENDED.

» PLEASE CONSULT

SLIMGOT



COAXIAL TRIMLESS



		P	CCT	I	Flux	LOR
SLIMGOT 120	A203-1- -01- WT NT	14,8W	3000K	500mA	2360Lm	85%
	A203-1- -02- WT NT	14,8W	4000K	500mA	2400Lm	85%
SLIMGOT 150	A203-2- -01- WT NT	21W	3000K	700mA	3300Lm	85%
	A203-2- -02- WT NT	21W	4000K	700mA	3350Lm	85%

| 220V~ | IP20 | CRI>90 | L80B10 >60.000h

*OPTIONS

1	No DIM
2	DIM DALI / Push

WIRE TRIMLESS ACCESSORY

COAXIAL TRIMLESS A023-00-03- | W | N |

Feeding: Only 1 piece needed.
Fasteners not available

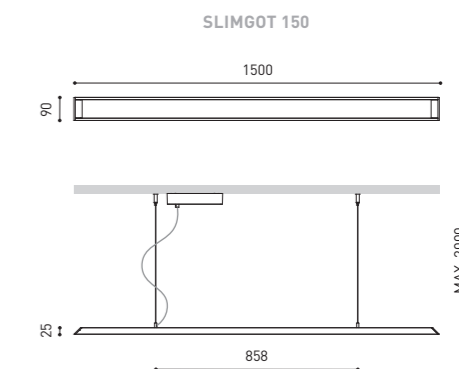
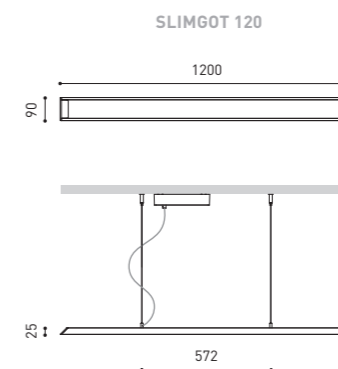
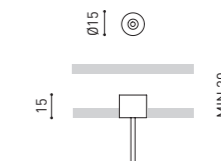

COLOUR | WT RAL 9016 | NT RAL 9005 | MATERIAL | AL | PMMA | » 42

» PLEASE CONSULT

WIRE TRIMLESS ACCESSORY
FIFTY SUSPENSION



		P	CCT	I	Flux	LOR	L
FIFTY SUSPENSION 90	A233-01- Ⓞ -1- WT NT	15,3W	3000K	600mA	2190Lm	70%	864mm
	A233-01- Ⓞ -2- WT NT	15,3W	4000K	600mA	2250Lm	70%	864mm
FIFTY SUSPENSION 120	A233-02- Ⓞ -1- WT NT	20,4W	3000K	600mA	2920Lm	70%	1148mm
	A233-02- Ⓞ -2- WT NT	20,4W	4000K	600mA	3000Lm	70%	1148mm
FIFTY SUSPENSION 150	A233-03- Ⓞ -1- WT NT	25,5W	3000K	600mA	3650Lm	70%	1432mm
	A233-03- Ⓞ -2- WT NT	25,5W	4000K	600mA	3750Lm	70%	1432mm
FIFTY SUSPENSION 300	A233-04- Ⓞ -1- WT NT	51W	3000K	600mA	7300Lm	70%	2852mm
	A233-04- Ⓞ -2- WT NT	51W	4000K	600mA	7500Lm	70%	2852mm

		P	CCT	I	Flux	LOR	L
FIFTY H0 SUSPENSION 90	A293-01- Ⓞ -1- WT NT	23,1W	3000K	900mA	3225Lm	70%	864mm
	A293-01- Ⓞ -2- WT NT	23,1W	4000K	900mA	3300Lm	70%	864mm
FIFTY H0 SUSPENSION 120	A293-02- Ⓞ -1- WT NT	30,8W	3000K	900mA	4300Lm	70%	1148mm
	A293-02- Ⓞ -2- WT NT	30,8W	4000K	900mA	4400Lm	70%	1148mm
FIFTY H0 SUSPENSION 150	A293-03- Ⓞ -1- WT NT	38,5W	3000K	900mA	5375Lm	70%	1432mm
	A293-03- Ⓞ -2- WT NT	38,5W	4000K	900mA	5500Lm	70%	1432mm
FIFTY H0 SUSPENSION 300	A293-04- Ⓞ -1- WT NT	77W	3000K	900mA	10750Lm	70%	2852mm
	A293-04- Ⓞ -2- WT NT	77W	4000K	900mA	11000Lm	70%	2852mm

LED | 220-240V~ | CE | IP20 | CRI>90 | L80B10 >60.000h



Ⓞ *OPTIONS

1	No DIM
2	DIM Push / DALI

WIRE TRIMLESS ACCESSORIES

FEED

MAINS TRIMLESS

A023-00-01- | W | N | NO DIM

MAINS THICK TRIMLESS

A023-00-02- | W | N | DIM

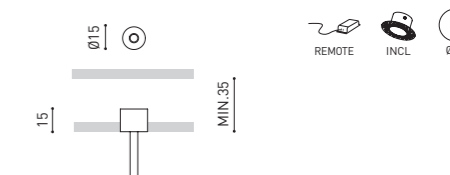

FASTENING

STEEL CABLE TRIMLESS*

A023-00-05- | W | N |



FIFTY SUSPENSION

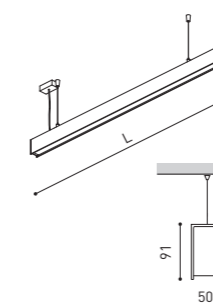

COLOUR | WT □ RAL 9016 | NT ■ RAL 9005 | MATERIAL | AL | PC | » 42

* AS MANY PIECES AS NEEDED ACCORDING TO YOUR PRODUCT

» PLEASE CONSULT



		P	CCT	I	Flux	LOR	L
FIFTY Suspension Custom 90	A233-11- Ⓞ -1- WT NT	15,3W	3000K	600mA	2190Lm	70%	854mm
	A233-11- Ⓞ -2- WT NT	15,3W	4000K	600mA	2250Lm	70%	854mm
FIFTY Suspension Custom 120	A233-12- Ⓞ -1- WT NT	20,4W	3000K	600mA	2920Lm	70%	1138mm
	A233-12- Ⓞ -2- WT NT	20,4W	4000K	600mA	3000Lm	70%	1138mm
FIFTY Suspension Custom 150	A233-13- Ⓞ -1- WT NT	25,5W	3000K	600mA	3650Lm	70%	1422mm
	A233-13- Ⓞ -2- WT NT	25,5W	4000K	600mA	3750Lm	70%	1422mm
FIFTY Suspension Custom 300	A233-14- Ⓞ -1- WT NT	51W	3000K	600mA	7300Lm	70%	2842mm
	A233-14- Ⓞ -2- WT NT	51W	4000K	600mA	7500Lm	70%	2842mm

		P	CCT	I	Flux	LOR	L
FIFTY H0 Suspension Custom 90	A293-11- Ⓞ -1- WT NT	23,1W	3000K	900mA	3225Lm	70%	854mm
	A293-11- Ⓞ -2- WT NT	23,1W	4000K	900mA	3300Lm	70%	854mm
FIFTY H0 Suspension Custom 120	A293-12- Ⓞ -1- WT NT	30,8W	3000K	900mA	4300Lm	70%	1138mm
	A293-12- Ⓞ -2- WT NT	30,8W	4000K	900mA	4400Lm	70%	1138mm
FIFTY H0 Suspension Custom 150	A293-13- Ⓞ -1- WT NT	38,5W	3000K	900mA	5375Lm	70%	1422mm
	A293-13- Ⓞ -2- WT NT	38,5W	4000K	900mA	5500Lm	70%	1422mm
FIFTY H0 Suspension Custom 300	A293-14- Ⓞ -1- WT NT	77W	3000K	900mA	10750Lm	70%	2842mm
	A293-14- Ⓞ -2- WT NT	77W	4000K	900mA	11000Lm	70%	2842mm

220V~ | IP20 | CRI>90 | L80B10 > 60.000h
 MacAdam Step 2
 OPTIONS*
 CABLE 2m
 FAST
 INCL | DIFFUSER
 FAST | CONNEC
 INCL
 102°

Ⓞ *OPTIONS

1	No DIM
2	DIM Push / DALI

FIFTY 2 End Cap Kit	1050-00-10- WT NT	
FIFTY Straight Joiner	1050-01-80	
FIFTY Suspension Cable	1050-00-01	At least 2 units needed. Extra unit each 120 cm. required
FIFTY Suspension Power Line	A233-00-00- WT NT	
	A233-00-10- WT NT	

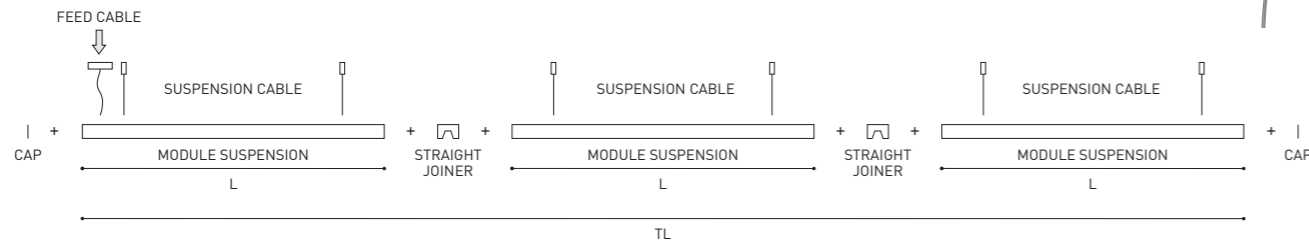

COLOUR | WT □ RAL 9016 | NT ■ RAL 9005 | MATERIAL | AL | PC | » 42

» PLEASE CONSULT



MAINS TRIMLESS

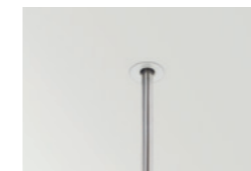

MAINS THICK TRIMLESS



STEEL CABLE TRIMLESS

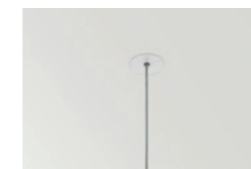

WIRE TRIMLESS ACCESSORIES

FEED

MAINS TRIMLESS*

A023-00-01- | W | N |



MAINS THICK TRIMLESS*

A023-00-02- | W | N |

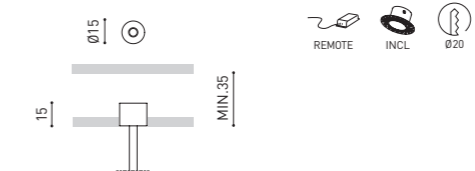

FASTENING

STEEL CABLE TRIMLESS*

A023-00-05- | W | N |

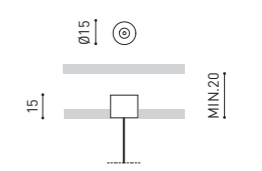

COLOUR | W □ RAL 9016 | N ■ RAL 9005 |

» 42

* AS MANY PIECES AS NEEDED ACCORDING TO YOUR PRODUCT

MINIMAL TRACK SUSPENSION

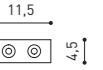
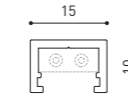
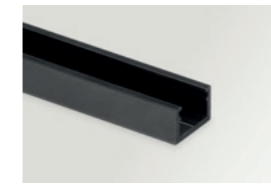
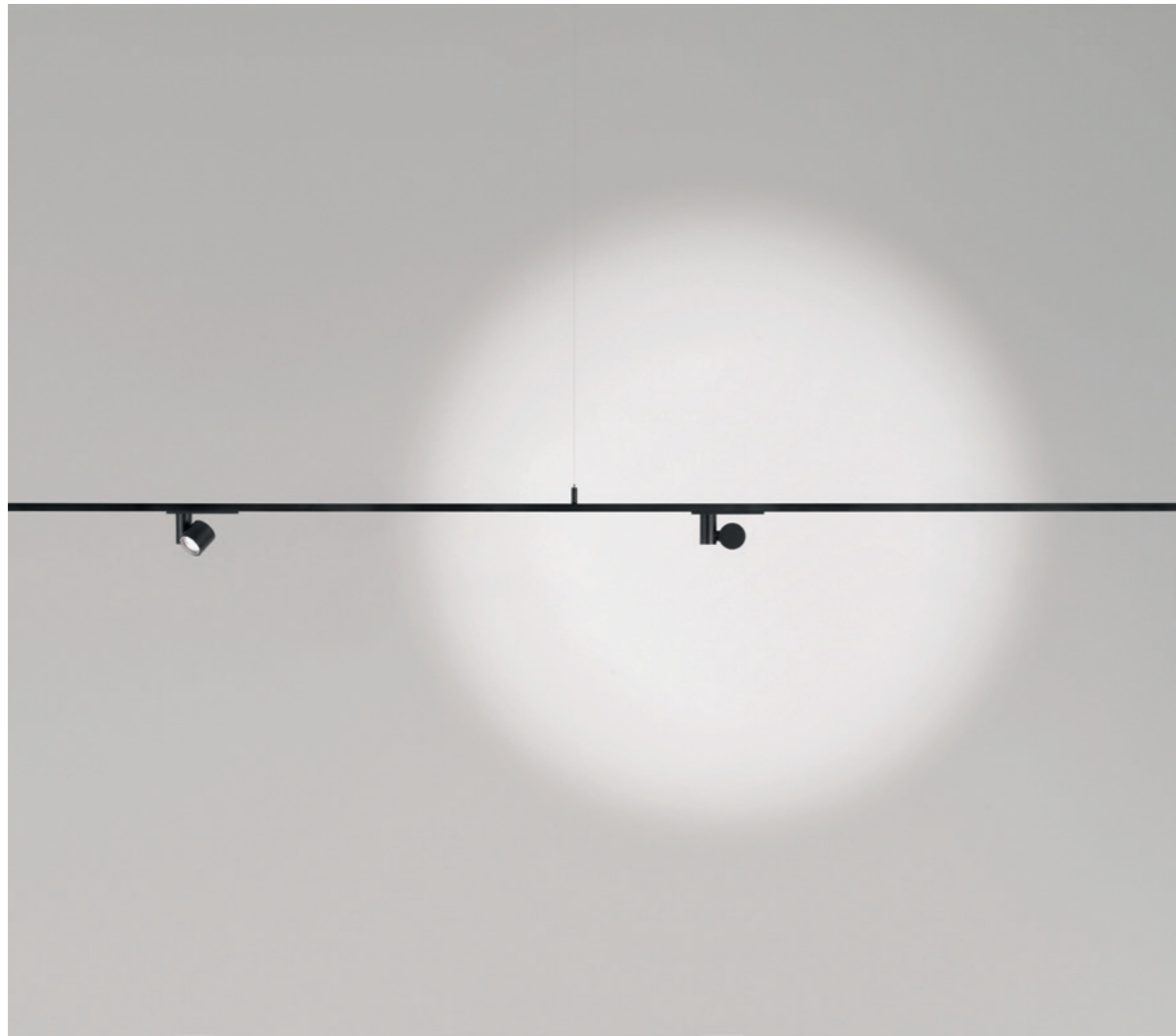

MINIMAL TRACK 24V Suspension

Profile 2m

A384-02-00- | N |

Profile 2m Initial feed kit

A400-02-10- | N |

Profile 2m Middle feed kit*

A400-02-20- | N |

* Unidirectional Middle Feed.

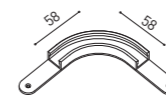
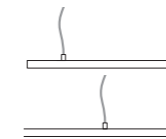

MINIMAL TRACK 24V Suspension Corner 90°

A400-00-03- | N |

Cable Length = 85mm.

MINIMAL TRACK 24V Suspension

Rubber Cable n x 1m

A400-00-01- | N |

n = Total Length of System.

24V | Max. 4A | CE | II

MINIMAL TRACK 24V Suspension Straight Joiner

A400-00-02- | N |

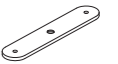

MINIMAL TRACK 24V Suspension Kit

A400-02-04- | N |

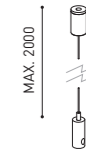

MINIMAL TRACK 24V Suspension End Caps

A400-00-05- | N |

Two End Caps Included



			P	V	D (A x B x C)
MINIMAL TRACK 24V Suspension Power Supply Box	ON/OFF	A400-00-06- NT	40W	24V	280 x 30 x 36mm
		A400-00-07- NT	100W	24V	280 x 30 x 36mm
Included ON/OFF 24Vdc Power Supply Not used with wire trimless installation					
MINIMAL TRACK 24V Remote Power Supply	ON/OFF	0434-01-37	60W	24V	180 x 52 x 30mm
		0433-10-22	100W	24V	295 x 43 x 30mm

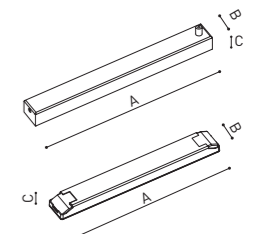

DROP VOLTAGE TABLE

POWER [W]	CABLE SECTION [mm ²]	CABLE LENGTH [m]			
		<5	<10	<20	<30
40	0,75	30	30	30	30
	1,5	30	30	30	30
60	0,75	30	30	20	10
	1,5	30	30	30	20
100	0,75	20	10	X	X
	1,5	20	20	10	X

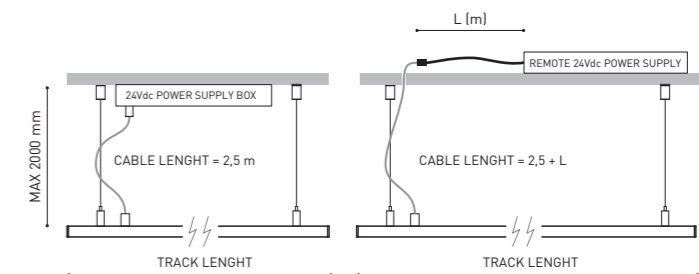

WIRE TRIMLESS ACCESSORY

COAXIAL TRIMLESS*

A023-00-03- | W | N |

FASTENERS NOT AVAILABLE.

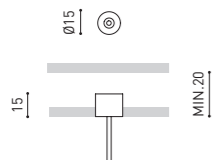
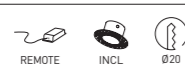

COAXIAL TRIMLESS

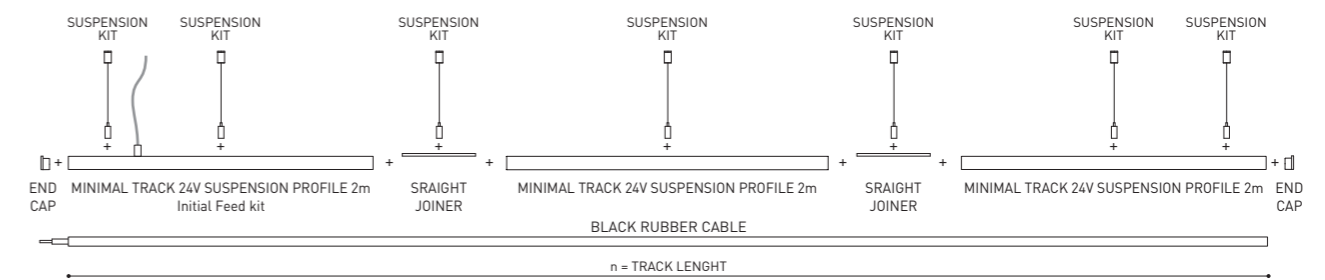
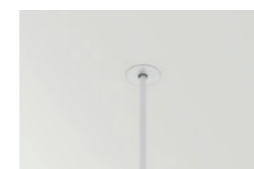

COLOUR | N ■ | NT ■ RAL 9005 |



* AS MANY PIECES AS NEEDED ACORDING TO YOUR PRODUCT | DIM OPTIONS PLEASE CONSULT

TRACK 48V SUSPENSION

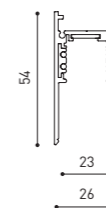

TRACK 48V SURFACE

TRACK 48V SURFACE 1m	A338-11-00- NT WT
TRACK 48V SURFACE 2m	A338-12-00- NT WT
TRACK 48V SURFACE 3m	A338-13-00- NT WT
TRACK 48V SURFACE Corner 90° One Plane	A338-14-00- NT WT



TRACK 48V SURFACE Corner 90° One Plane

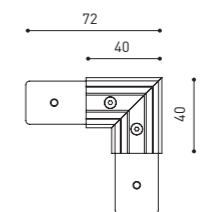

*Electrical connection not included

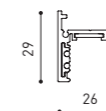

TRACK 48V SURFACE SHORT

TRACK 48V SURFACE SHORT 1m	A338-21-00- NT WT
TRACK 48V SURFACE SHORT 2m	A338-22-00- NT WT
TRACK 48V SURFACE SHORT 3m	A338-23-00- NT WT
TRACK 48V SURFACE SHORT Corner 90° One Plane	A338-24-00- NT WT



TRACK 48V SURFACE SHORT Corner 90° One Plane

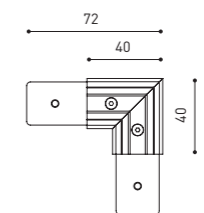

*Electrical connection not included

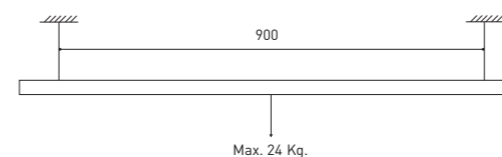

		P	V	D
CONSTANT VOLTAGE	0434-01-21	75W	48V	180 x 52 x 30mm
LED POWER SUPPLY	0434-01-22	150W	48V	240 x 60 x 49mm

DROP VOLTAGE TABLE

POWER (W)	CABLE SECTION (mm ²)	CABLE LENGTH (m)			
		5	10	20	30
75	0,75	50	50	30	X
	1,5	50	50	50	50
150	0,75	40	15	X	X
	1,5	50	40	20	X



ACCESSORIES TRACK 48V

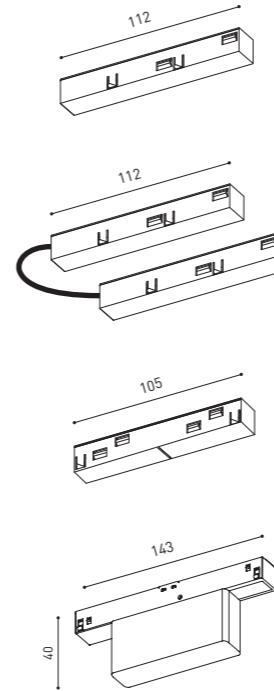

TRACK 48V Live-End Connector
A338-00-01- | N | W |

TRACK 48V Corner 90° Connector
A338-00-12- | N | W |

TRACK 48V Central Connector
A338-00-02- | N | W |

TRACK 48V Wireless Control
0434-01-31- | N | W | Casambi/AAG Stucchi App
0434-01-32- | N | W | AAG Stucchi App

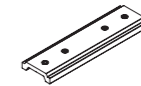

TRACK 48V SURFACE Straight Joiner
A338-00-11

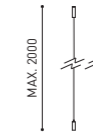

TRACK 48V SURFACE Suspension Kit (2 units)
A338-00-15- | NT | WT |

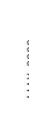

TRACK 48V SURFACE Suspension Feed Kit
A338-00-16- | N | W | NO DIM
A338-00-17- | N | W | DIM
*For remote power supply

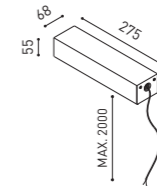

TRACK 48V Wired Power Supply Case
A338-00-22- | NT | WT | NO DIM
A338-00-23- | NT | WT | DIM
*Power supply not included
Not used with wire trimless installation

WIRE TRIMLESS ACCESSORIES

FEED

MAINS TRIMLESS*

A023-00-01- | W | N | NO DIM

MAINS THICK TRIMLESS*

A023-00-02- | W | N | DIM



MAINS TRIMLESS

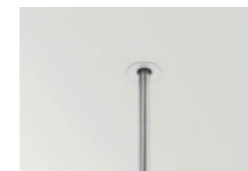

MAINS THICK TRIMLESS

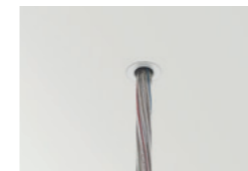

STEEL CABLE TRIMLESS

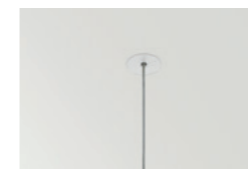

FASTENING

STEEL CABLE TRIMLESS*

A023-00-05- | W | N |

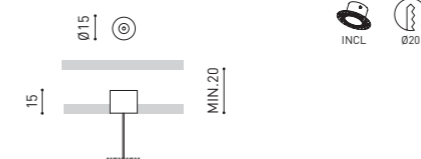

COLOUR | N ■ RAL 9005 | W □ RAL 9016 | NT ■ RAL 9005 | WT □ RAL 9016 |

* AS MANY PIECES AS NEEDED ACCORDING TO YOUR PRODUCT

SUSPENSION 48V

TRACK 48V TRIMLESS & SURFACE End
A338-00-06- | NT | WT |



















TRACK 48V TRIMLESS & SURFACE End Feed
A338-00-07- | NT | WT |

SUSPENSION SHORT 48V

TRACK 48V SURFACE SHORT End
A338-00-18- | NT | WT |















TRACK 48V SURFACE SHORT End Feed
A338-00-19- | NT | WT |

Glossaire

P	Puissance		Marquage CE
CCT	Température de couleur		Certifié ENEC
I	Intensité de courant		Classe I
Flux	Flux lumineux brut		Classe II
L	Longueur (en mm).		Classe III
LOR	<i>Lumen Output Ratio</i> . Rapport entre le flux de sortie du luminaire et le flux de sortie de la source de lumière		Stabilité chromatique: Pas MacAdam
IPXX	Indice d'étanchéité		Gradable
BEAM	Angle du faisceau lumineux		Équipement électronique inclus
CRI	Indice de rendu des couleurs		Équipement à distance
AL	Aluminium		Espace d'emplacement en mm pour encastrables
PC	Polycarbonate		Connexion rapide
BR	Laiton		Longueur de câble
ABS	Acrylonitrile Butadiène Styrene		Régulation rapide du câble de suspension
PMMA	Polyméthacrylate de méthyle		Accessoire Trimless
TRANS	Transparent		Diffuseur
D	Dimensions (en mm)		Diffuseur
V	Tension de sortie d'alimentation		Contrôle par bluetooth
220 V- 240 V	Tension d'alimentation de l'ampoule 220-240V		Type d'installation et direction du faisceau lumineux
48 V	Tension d'alimentation de l'ampoule 48vdc		Confort visuel. UGR (<i>Unified Glare Rating</i>)
24 V	Tension d'alimentation de l'ampoule 24vdc		Fabriqué en
	Lampe LED		Réflecteur

Couleurs

Les valeurs d'éclairage indiquées pour chaque code de référence correspondent aux résultats obtenus lors des essais réalisés sur la première couleur indiquée dans la liste.

	N Noir mat = RAL 9005		MG Or métallique**
	NT Noir texturé = RAL 9005		MC Cuivre métallique**
	W Blanc = RAL 9016		BG Or Brossé**
	WT Blanc texturé = RAL 9016		BC Cuivre Brossé**
	O Orange = RAL 7022*		WTMG Blanc texturé - Or métallique**
	R Rouge = RAL 3018*		NMG Noir mat - Or métallique**
	G Or = RAL 1036*		NTMG Noir texturé - Or métallique**

* Couleur de masse similaire à RAL.
** RAL non disponible. Finition métallique.

ARKOSLIGHT®

Calle N · Pol. Ind. EL OLIVERAL
46394 Ribarroja del Turia · Valencia [Spain]
Tel. +34 961 667 207 · Fax +34 961 667 054
info@arkoslight.com · www.arkoslight.com
France: +33 182 885 200 · Italia: +39 02 9475 0007
Deutschland: +49 22 182 829 313



LIGHT&LIFE
— DESDE 1984 —