



Coffrets réseaux Double Play

4 132 61 - 4 182 61

Notice d'installation



FLASHEZ-MOI



et accédez aux compléments d'informations d'installation

■ PRÉSENTATION COFFRETS

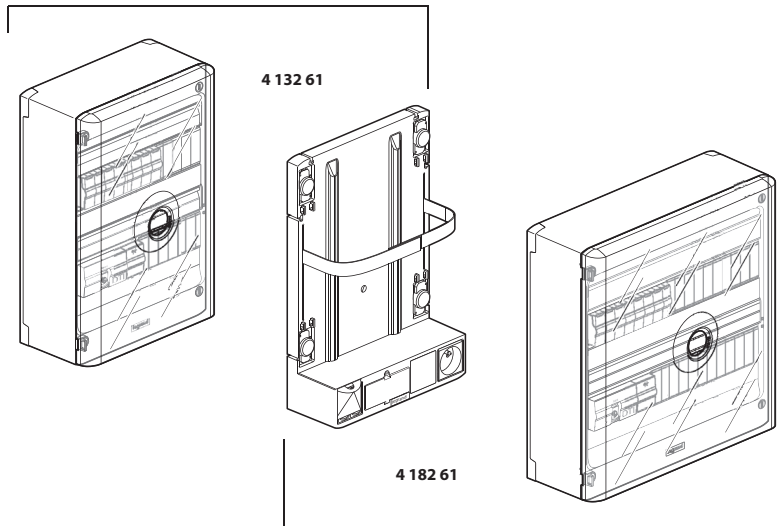

Répond aux exigences de la NF C 15-100 qui prend en compte l'arrêté sur les réseaux de communication

Coffret prêt à recevoir l'arrivée fibre optique

⚠ Consignes de sécurité

Ce produit doit être installé conformément aux règles d'installation et de préférence par un électricien qualifié. Une installation et une utilisation incorrectes peuvent entraîner des risques de choc électrique ou d'incendie. Avant d'effectuer l'installation, lire la notice, tenir compte du lieu de montage spécifique au produit.

Ne pas ouvrir, démonter, altérer ou modifier l'appareil sauf mention particulière indiquée dans la notice. Tous les produits Legrand doivent exclusivement être ouverts et réparés par du personnel formé et habilité par Legrand. Toute ouverture ou réparation non autorisée annule l'intégralité des responsabilités, droits à remplacement et garanties.

Utiliser exclusivement les accessoires de la marque Legrand.

⚠ إرشادات الأمان:

يجب تركيب هذا المنتج طبقاً لقواعد التركيب ويفضل أن يقوم بالتركيب كهربائي مؤهل. فقد يؤدي التركيب والاستخدام غير لصحيح إلى مخاطر التعرض لصدمة كهربائية أو نشوب حريق. اقرأ النشرة قبل التركيب. وأقر مكاناً لتركيب المنتج خاصاً به. لا تفتح أو تفك أو تعدل أو تخوّر المنتج ما لم يُشير إلى ذلك بشكل محدد في النشرة. فكل منتجات Legrand يجب فتحها وإصلاحها حصراً من قبل فنيين مدربين ومؤهلين لدى Legrand. وكل فتح أو إصلاح غير مسموح به يُبطل المسؤوليات وحقوق الاستبدال والضمانات. لا تستخدم سوى إكسسوارات من ماركة Legrand حصراً.



Ce symbole indique qu'en fin de vie, le produit doit être collecté séparément des autres déchets et remis à un centre de collecte agréé dans le respect des normes et dispositions légales en vigueur dans les pays de l'UE, pour prévenir les effets indésirables sur l'environnement et la santé des personnes. L'élimination abusive du produit est passible des sanctions prévues par la loi. Il est recommandé de s'assurer que dans le pays où le produit est utilisé, ce dernier est soumis aux réglementations WEEE/DEEE.

• Nota :

- La sécurité de cet appareil n'est assurée que si l'utilisateur respecte l'ensemble des instructions fournies dans cette notice.
- Il est très fortement recommandé d'installer systématiquement un parafoudre de puissance dans le tableau d'abonné (NFC 15-100 § 444.3.3), ainsi qu'un parafoudre téléphonique analogique.
- L'installation doit être conforme à la norme NFC 15-100 (et au guide 15-443 pour les parafoudres) :
- cet appareil doit être installé dans un circuit protégé par un disjoncteur 10A (ou 16A)
- parafoudre de puissance dans le tableau d'abonné
- parafoudre téléphonique analogique

■ COMPOSITION DES COFFRETS

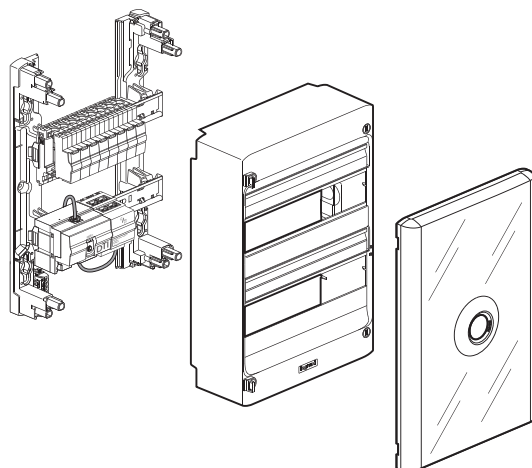

■ COMPOSANTS PRE-INSTALLÉS

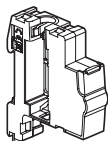

x 8

Modules de brassage

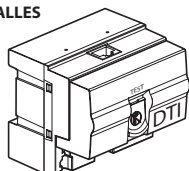

DTI RJ 45 modulaire

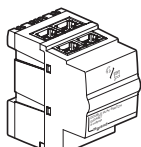

Centrale Double Play Gigabit



Cordon de liaison DTI/
centrale Double Play
(0,18 m)

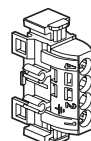

Bornier de terre

■ COMPOSANTS A INSTALLER

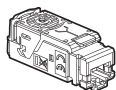

x 8

Connecteurs RJ 45
Cat 6 STP

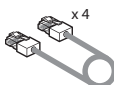

x 4

Cordons de brassage RJ 45
F/UTP



Cordon quadruple

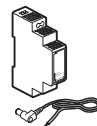

Alimentation 9 V
+ cordon d'alimentation

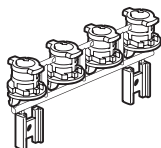

Grappe de fixation

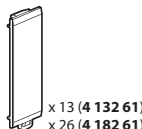

x 13 (4 132 61)
x 26 (4 182 61)

Obturbateurs

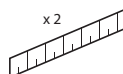

x 2

Bandes d'étiquettes
de plastron

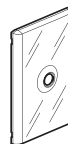

Porte de coffret

■ ACCESSOIRES POUR BOX OPÉRATEUR

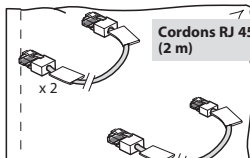

Cordons RJ 45/RJ 45
(2 m)

x 2

x 2

Cordons RJ 45/RJ 11
(2 m)

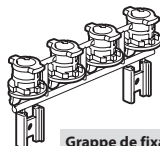

Grappe de fixation

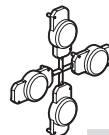

Grappe de
bouchons

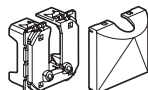

Sortie de câble



Obturbateur



Prise 2 P+T - 16 A

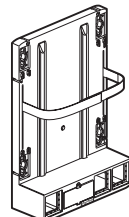

Support box
opérateur

■ SCHEMAS DE PRINCIPE

Position Phone / Box en ambiance

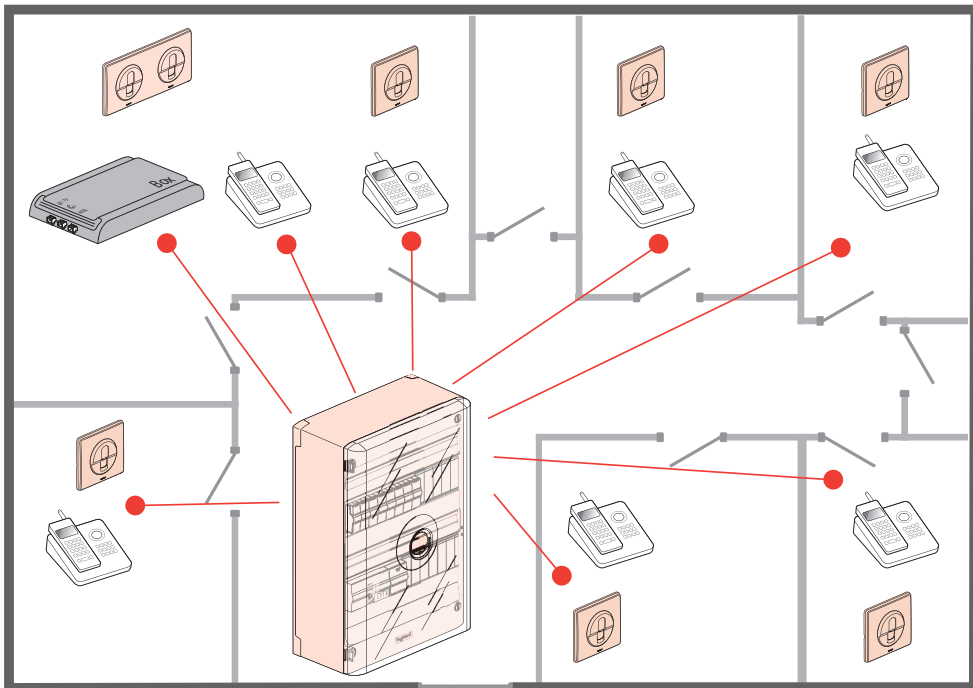

Position LAN@ / Box dans support box

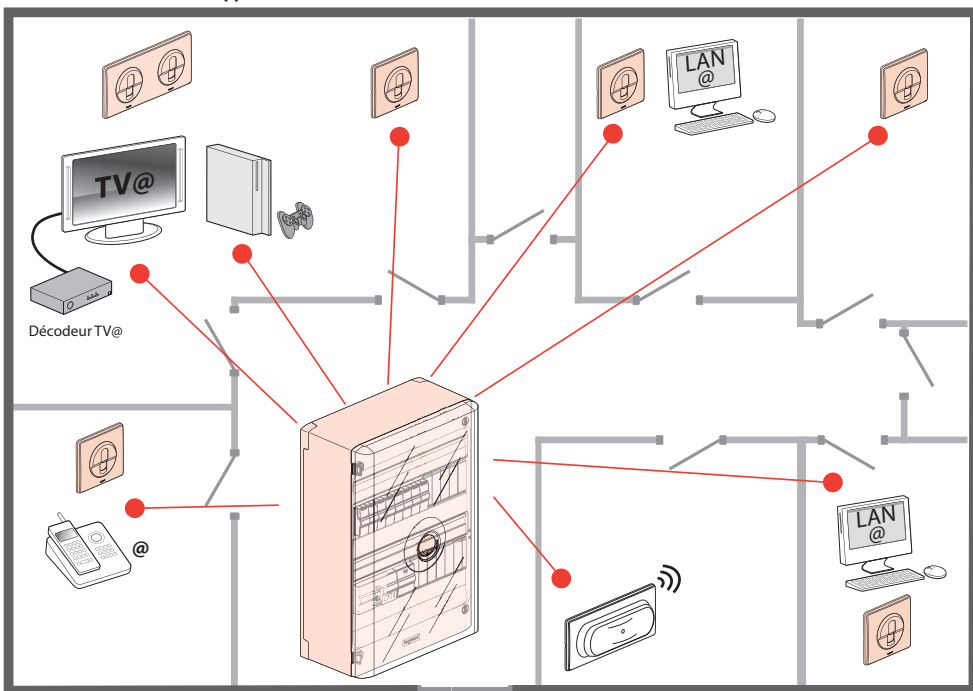

■ FIXATION

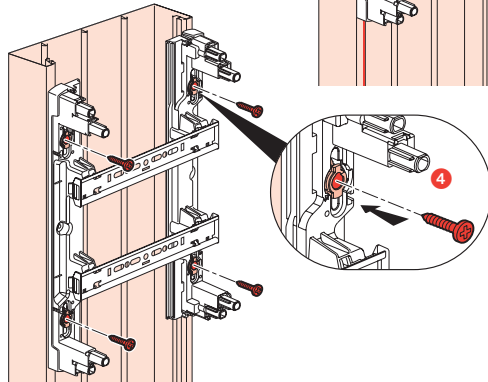
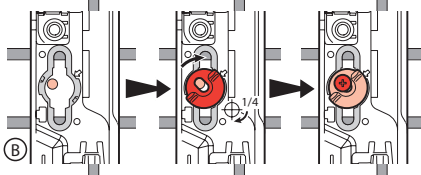
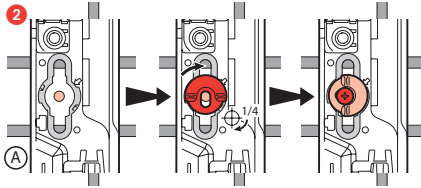
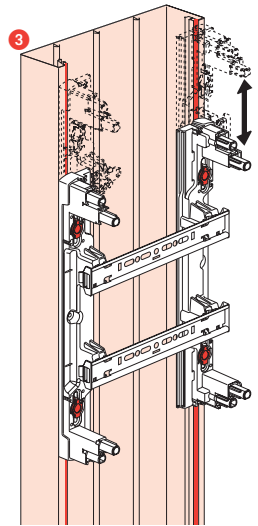
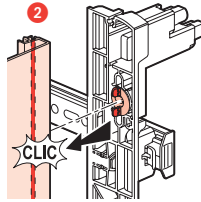
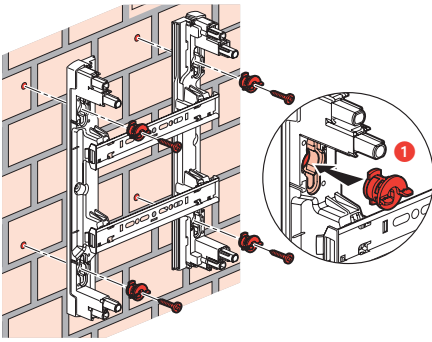
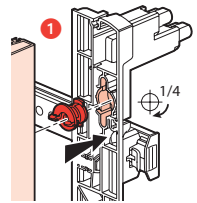
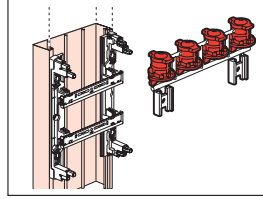
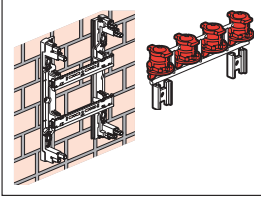
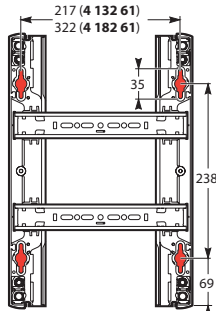

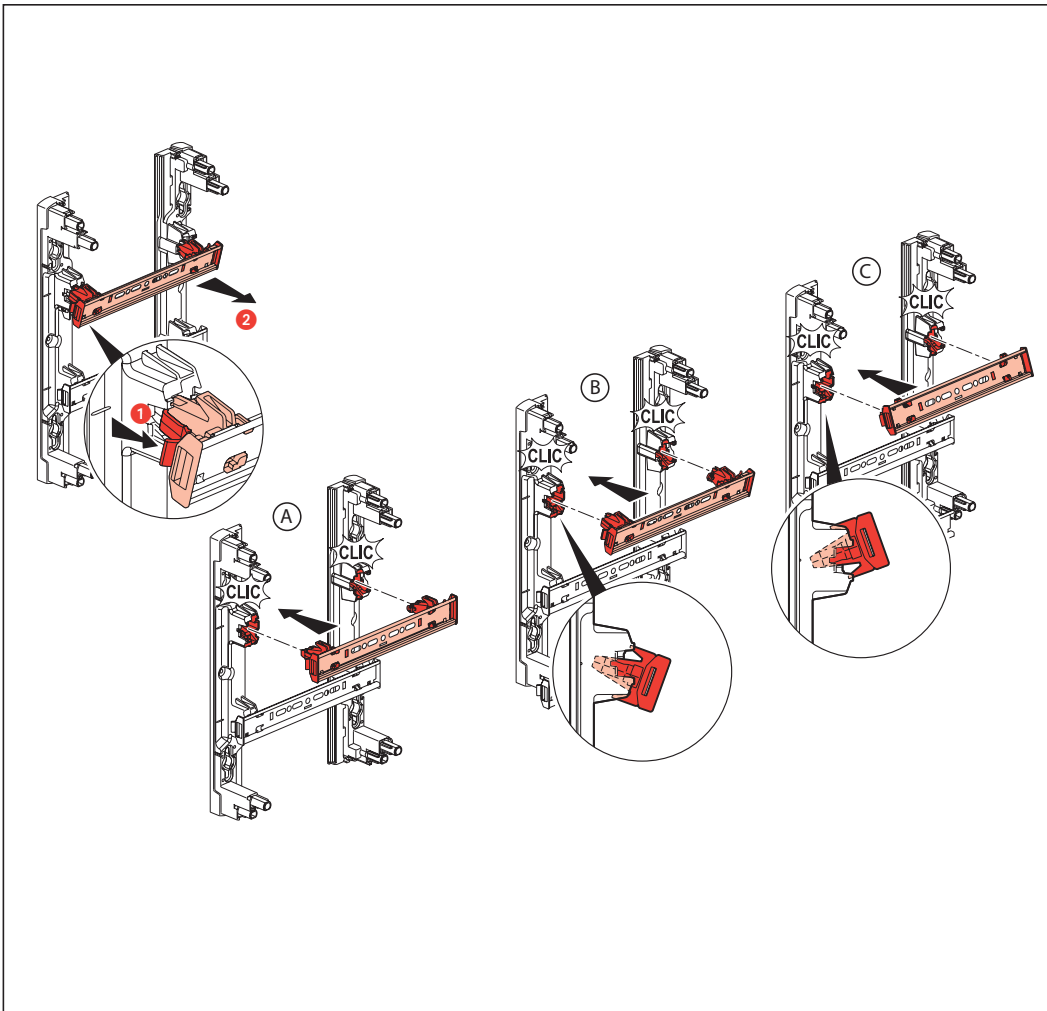

■ DISPOSITION DES DÉPARTS RJ 45

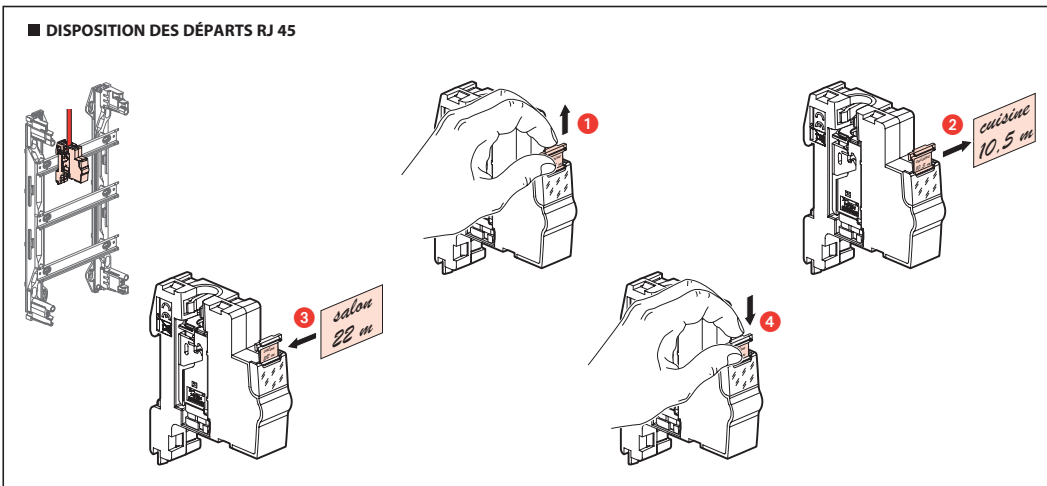

■ CABLAGE

Câble Grade 2 TV réf. 0 327 88

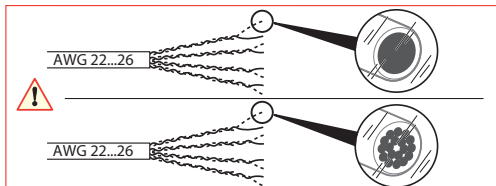
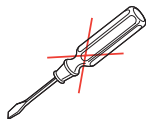
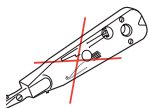
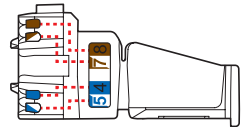
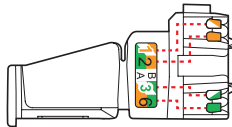
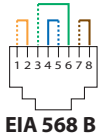
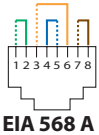
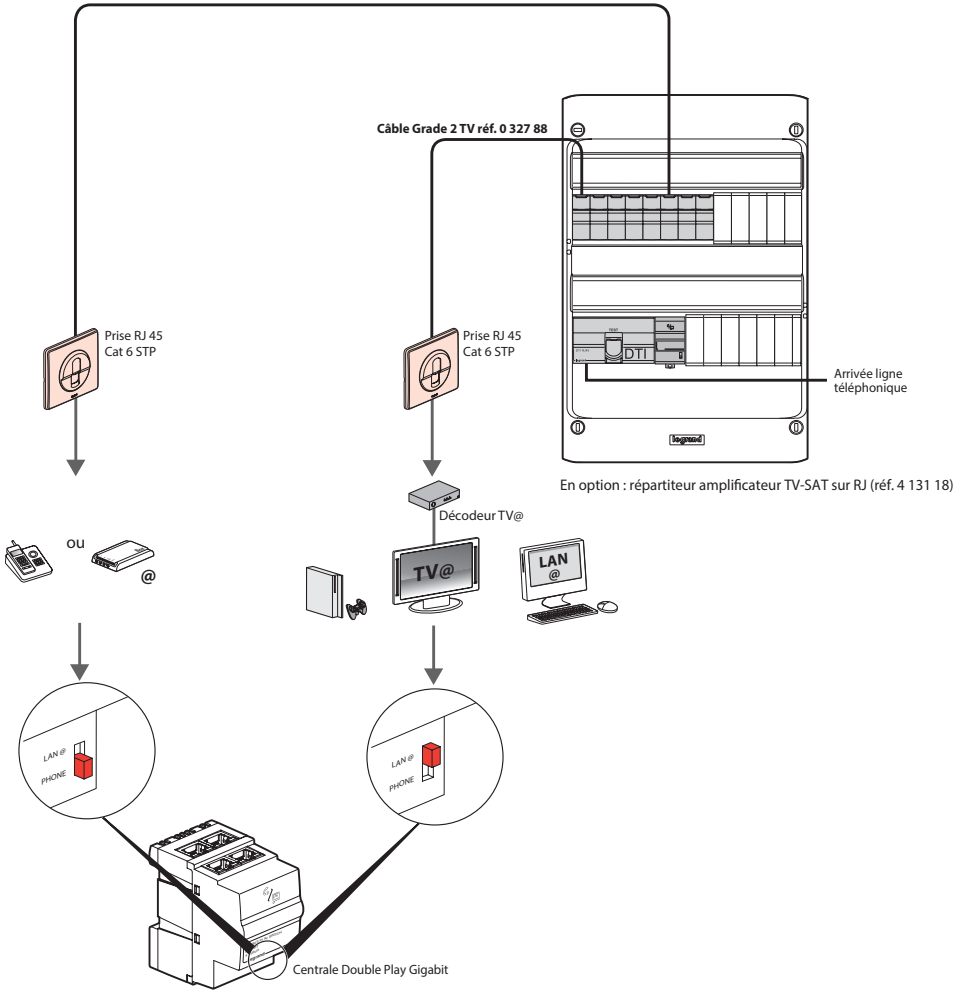

■ PREPARATION DU CÂBLE GRADE 2 TV RÉF. 0 327 88

0 332 62

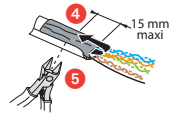
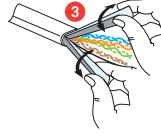
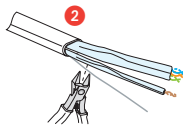
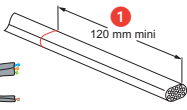

0 327 88
Câble Grade 2 TV
F/UTP dont 1 paire écrantée

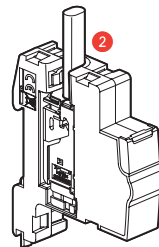
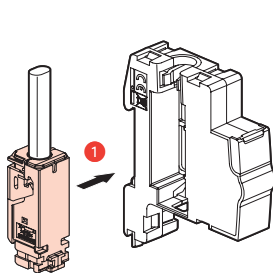
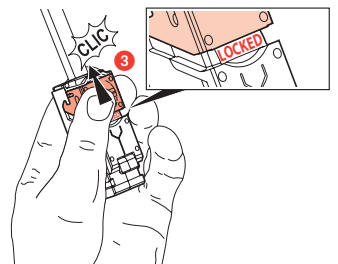
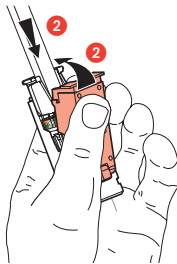
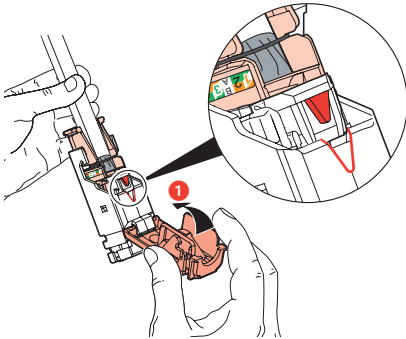
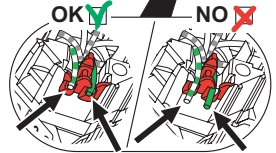
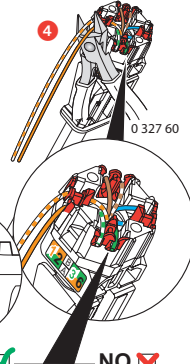
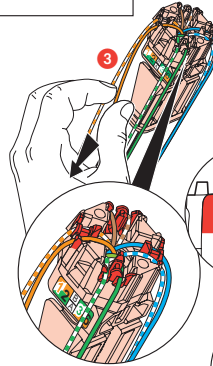
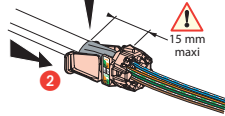
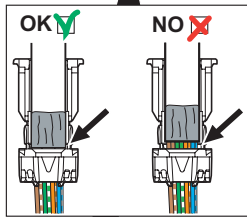
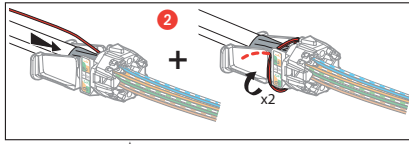
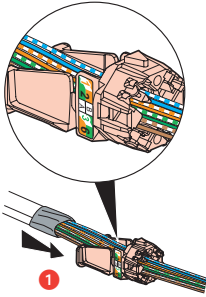

■ MISE EN OEUVRE DE LA CENTRALE DOUBLE PLAY

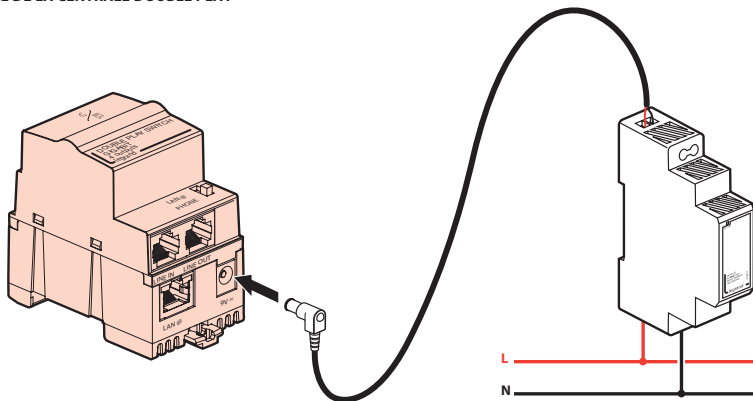

Installer l'alimentation dans le tableau électrique.
Respecter une distance d'aération de 5 mm à gauche
et à droite, 40 mm au-dessus et 20 mm en dessous.

■ MISE EN OEUVRE DU DTI

