



# WL8G-P1131S03

W8G

MINIATURE PHOTOELECTRIC SENSORS

**SICK**  
Sensor Intelligence.



Illustration may differ



## Ordering information

Type	Part no.
WL8G-P1131S03	6052330

**Included in delivery:** BEF-W100-A (1), P250F (1)

Other models and accessories → [www.sick.com/W8G](http://www.sick.com/W8G)

## Detailed technical data

### Features

<b>Functional principle</b>	Photoelectric retro-reflective sensor
<b>Functional principle detail</b>	Autocollimation
<b>Dimensions (W x H x D)</b>	11 mm x 31 mm x 20 mm
<b>Housing design (light emission)</b>	Rectangular
<b>Sensing range max.</b>	0 m ... 3 m <sup>1)</sup>
<b>Sensing range</b>	0 m ... 1.7 m <sup>1)</sup>
<b>Type of light</b>	Visible red light
<b>Light source</b>	LED <sup>2)</sup>
<b>Light spot size (distance)</b>	Ø 70 mm (2 m)
<b>Wave length</b>	650 nm
<b>Adjustment</b>	Potentiometer, 270°
<b>Special feature</b>	Detecting transparent objects
<b>Special applications</b>	Detecting transparent objects

<sup>1)</sup> Reflector PL80A.

<sup>2)</sup> Average service life: 100,000 h at T<sub>J</sub> = +25 °C.

### Mechanics/electronics

<b>Supply voltage U<sub>B</sub></b>	10 V DC ... 30 V DC <sup>1)</sup>
<b>Ripple</b>	± 10 % <sup>2)</sup>

<sup>1)</sup> Limit values when operated in short-circuit protected network: max. 8 A.

<sup>2)</sup> May not exceed or fall below U<sub>V</sub> tolerances.

<sup>3)</sup> Without load.

<sup>4)</sup> Signal transit time with resistive load.

<sup>5)</sup> With light/dark ratio 1:1.

<sup>6)</sup> Do not bend below 0 °C.

<sup>7)</sup> A = V<sub>S</sub> connections reverse-polarity protected.

<sup>8)</sup> B = inputs and output reverse-polarity protected.

<sup>9)</sup> D = outputs overcurrent and short-circuit protected.

<b>Current consumption</b>	30 mA <sup>3)</sup>
<b>Switching output</b>	PNP
<b>Switching mode</b>	Light/dark switching
<b>Switching mode selector</b>	Selectable via light/dark rotary switch
<b>Signal voltage PNP HIGH/LOW</b>	Approx. $V_S - 1.8 \text{ V} / 0 \text{ V}$
<b>Output current <math>I_{\text{max}}</math></b>	$\leq 100 \text{ mA}$
<b>Response time</b>	$\leq 0.5 \text{ ms}$ <sup>4)</sup>
<b>Switching frequency</b>	1,000 Hz <sup>5)</sup>
<b>Attenuation along light beam</b>	$\leq 20 \%$
<b>Connection type</b>	Cable with M12 male connector, 4-pin, 300 mm <sup>6)</sup>
<b>Cable material</b>	PVC
<b>Circuit protection</b>	A <sup>7)</sup> B <sup>8)</sup> D <sup>9)</sup>
<b>Weight</b>	50 g
<b>Polarisation filter</b>	✓
<b>Special device</b>	✓
<b>Housing material</b>	Plastic, ABS
<b>Optics material</b>	Plastic, PMMA
<b>Enclosure rating</b>	IP67
<b>Items supplied</b>	Stainless steel mounting bracket (1.4301/304) BEF-W100-A
<b>Special feature</b>	Detecting transparent objects
<b>Ambient operating temperature</b>	-25 °C ... +55 °C
<b>Ambient temperature, storage</b>	-40 °C ... +70 °C

<sup>1)</sup> Limit values when operated in short-circuit protected network: max. 8 A.

<sup>2)</sup> May not exceed or fall below  $U_V$  tolerances.

<sup>3)</sup> Without load.

<sup>4)</sup> Signal transit time with resistive load.

<sup>5)</sup> With light/dark ratio 1:1.

<sup>6)</sup> Do not bend below 0 °C.

<sup>7)</sup> A =  $V_S$  connections reverse-polarity protected.

<sup>8)</sup> B = inputs and output reverse-polarity protected.

<sup>9)</sup> D = outputs overcurrent and short-circuit protected.

### Safety-related parameters

<b>MTTF<sub>D</sub></b>	1,028.4 years
<b>DC<sub>avg</sub></b>	0 %

### Classifications

<b>ECLASS 5.0</b>	27270902
<b>ECLASS 5.1.4</b>	27270902
<b>ECLASS 6.0</b>	27270902
<b>ECLASS 6.2</b>	27270902
<b>ECLASS 7.0</b>	27270902
<b>ECLASS 8.0</b>	27270902

<b>ECLASS 8.1</b>	27270902
<b>ECLASS 9.0</b>	27270902
<b>ECLASS 10.0</b>	27270902
<b>ECLASS 11.0</b>	27270902
<b>ECLASS 12.0</b>	27270902
<b>ETIM 5.0</b>	EC002717
<b>ETIM 6.0</b>	EC002717
<b>ETIM 7.0</b>	EC002717
<b>ETIM 8.0</b>	EC002717
<b>UNSPSC 16.0901</b>	39121528

### Dimensional drawing (Dimensions in mm (inch))

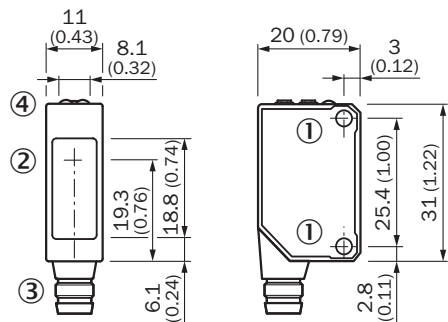

- ① Threaded mounting hole M3, max. tightening torque: 0.6 Nm
- ② Center of optical axis
- ③ Connection
- ④ Orange LED indicator : switching output active

### Adjustments

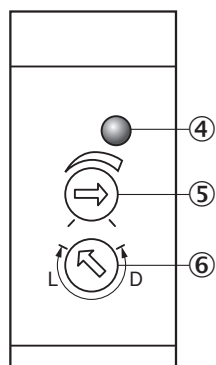

- ④ Orange LED indicator : switching output active
- ⑤ Sensitivity control
- ⑥ Light/ dark rotary switch: L = light switching, D = dark switching

Connection type

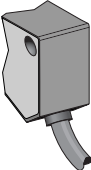

Connection diagram

Cd-066

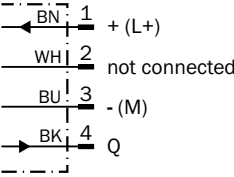

Characteristic curve

WL8G

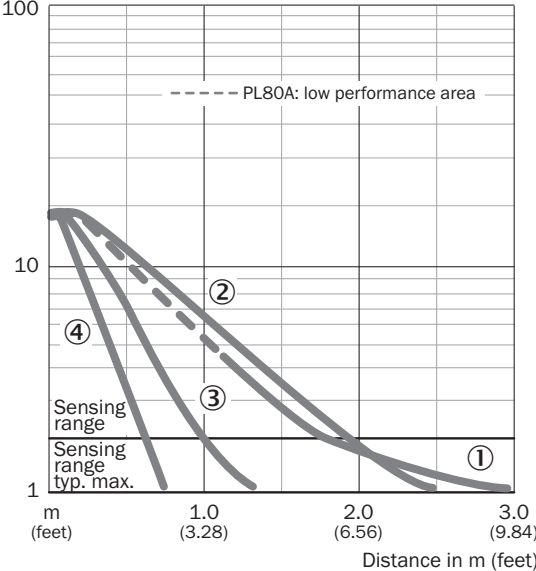

- ① Reflector PL80A
- ② Reflector P250F
- ③ Reflector PL20F
- ④ PL10F reflector

## Sensing range diagram

WL8G

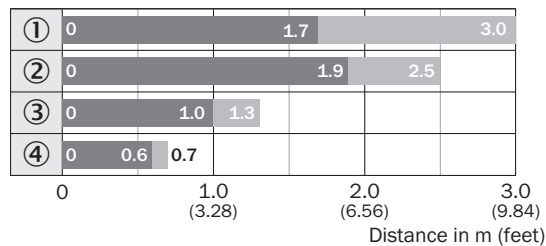





■ Sensing range      ■ Sensing range typ. max.

- ① Reflector PL80A
- ② Reflector P250F
- ③ Reflector PL20F
- ④ PL10F reflector

## Recommended accessories

Other models and accessories → [www.sick.com/W8G](http://www.sick.com/W8G)

	Brief description	Type	Part no.
<b>Mounting brackets and plates</b>			
	Universal mounting bracket for reflectors, steel, zinc coated	BEF-WN-REFX	2064574
<b>Plug connectors and cables</b>			
	<ul style="list-style-type: none"> <li>• <b>Connection type head A:</b> Male connector, M12, 4-pin, straight</li> <li>• <b>Description:</b> Unshielded</li> <li>• <b>Connection systems:</b> Screw-type terminals</li> <li>• <b>Permitted cross-section:</b> ≤ 0.75 mm<sup>2</sup></li> </ul>	STE-1204-G	6009932
<b>Reflectors</b>			
	Fine triple reflector, screw connection, suitable for laser sensors, 52 mm x 62 mm, PM-MA/ABS, Screw-on, 2 hole mounting	P250F	5308843
<b>Others</b>			
	<ul style="list-style-type: none"> <li>• <b>Connection type head A:</b> Female connector, M12, 4-pin, straight, A-coded</li> <li>• <b>Connection type head B:</b> Flying leads</li> <li>• <b>Signal type:</b> Sensor/actuator cable</li> <li>• <b>Cable:</b> 5 m, 4-wire, PVC</li> <li>• <b>Description:</b> Sensor/actuator cable, unshielded</li> <li>• <b>Application:</b> Zones with chemicals</li> </ul>	YF2A14-050VB3XLEAX	2096235

## SICK AT A GLANCE

SICK is one of the leading manufacturers of intelligent sensors and sensor solutions for industrial applications. A unique range of products and services creates the perfect basis for controlling processes securely and efficiently, protecting individuals from accidents and preventing damage to the environment.

We have extensive experience in a wide range of industries and understand their processes and requirements. With intelligent sensors, we can deliver exactly what our customers need. In application centers in Europe, Asia and North America, system solutions are tested and optimized in accordance with customer specifications. All this makes us a reliable supplier and development partner.

Comprehensive services complete our offering: SICK LifeTime Services provide support throughout the machine life cycle and ensure safety and productivity.

For us, that is “Sensor Intelligence.”

## WORLDWIDE PRESENCE:

Contacts and other locations –[www.sick.com](http://www.sick.com)