

⚠ ⚠ DANGER / DANGER / GEFAHR / PELIGRO / PERICOLO / ОПАСНО / 危險

HAZARD OF ELECTRIC SHOCK, EXPLOSION, OR ARC FLASH

Disconnect all power before servicing equipment.

Failure to follow these instructions will result in death or serious injury.

RISQUE D'ÉLECTROCUTION, D'EXPLOSION OU D'ECLAIR D'ARC ELECTRIQUE

Coupez toutes les alimentations avant de travailler sur cet appareil.

Le non-respect de ces instructions provoquera la mort ou des blessures graves.

GEFAHR VON ELEKTRISCHEM SCHLAG, EXPLOSION ODER LICHTBOGEN

Vor dem Arbeiten am Gerät alle Spannungsversorgungen abschalten.

Die Nichtbeachtung dieser Anweisungen führt zu Tod oder schwereren Verletzungen.

PELIGRO DE DESCARGA ELÉCTRICA, EXPLOSIÓN O ARCO ELECTRICO

Desconecte todas las alimentaciones antes de manipular el producto.

Si no se siguen estas instrucciones provocará lesiones graves o incluso la muerte.

RISCHIO DI SCARICA ELETTRICA , ESPLOSIONE O ARCO ELETTRICO

Scollegare l'apparecchio da tutti i circuiti di alimentazione prima di qualsiasi intervento.

Il mancato rispetto di queste istruzioni provocherà morte o gravi infortuni.

Опасность поражением электрическим током, опасностью взрыва или вспышки дуги.

Перед обслуживанием или ремонтом убедитесь, что питание отключено.

Несоблюдение этих инструкций приведет к смерти или серьезной травме.

可能有触电、爆炸或者电弧灼伤的危险

在此电力设备上进行操作时，请先断开所有电源，不遵循上述规定将可能导致人员伤亡。



W916395460111



A

LUB12 / LUB32

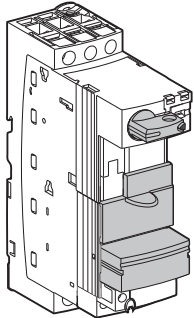

LUB120 / LUB320

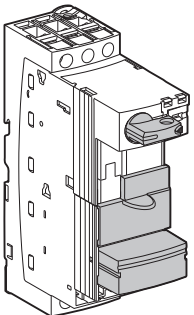

LU9BN11

B

LUB12/32 +LULC15

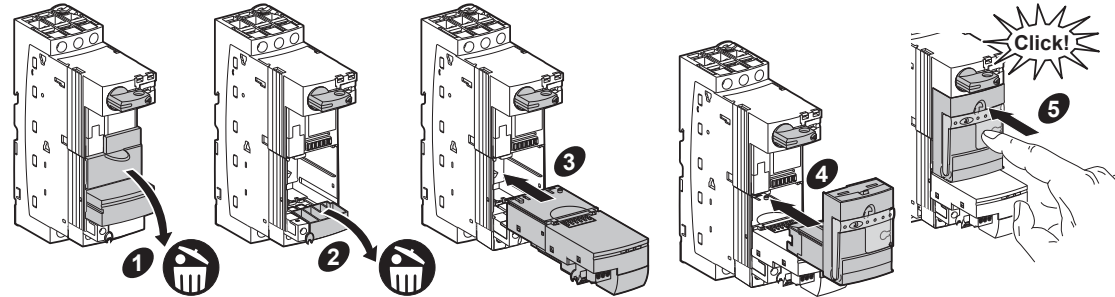
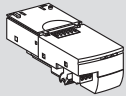

B'

LUB120/320 +LULC15

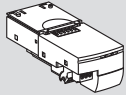

+LU9BN11L

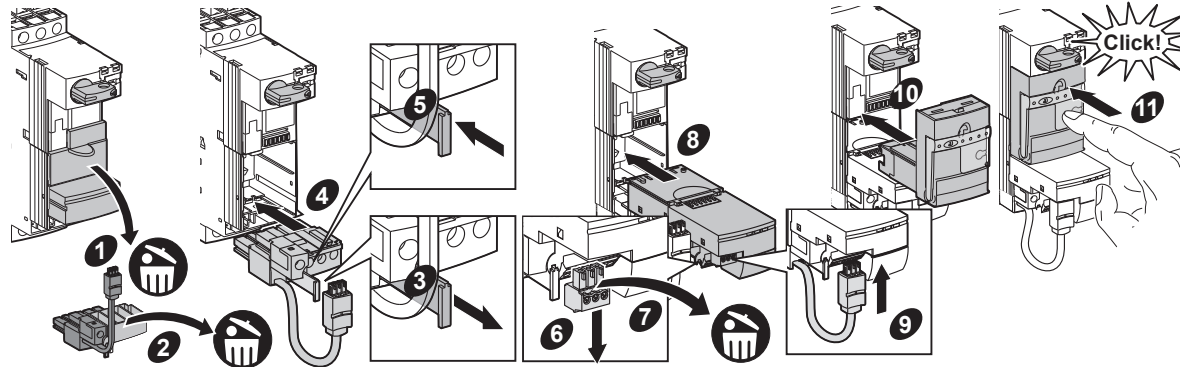

B''

LUB120/320 +LULC15

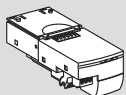

+LU9BN11

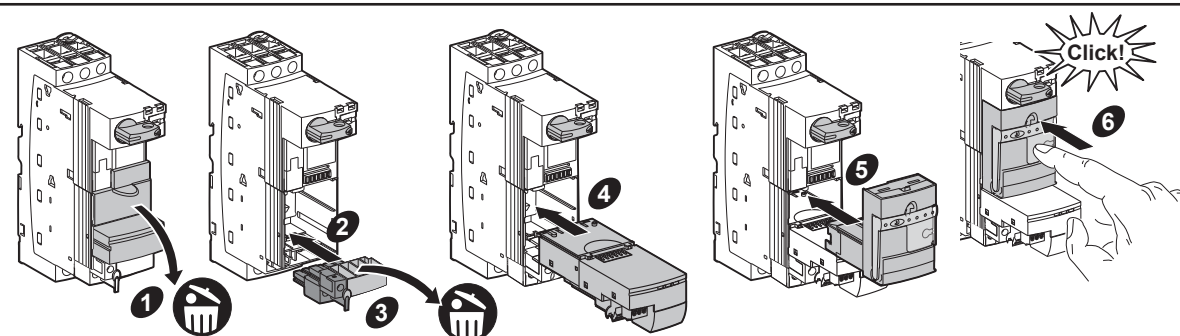

C

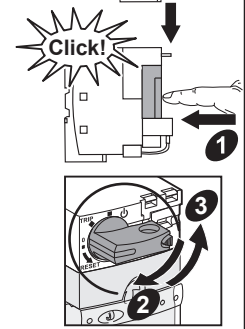
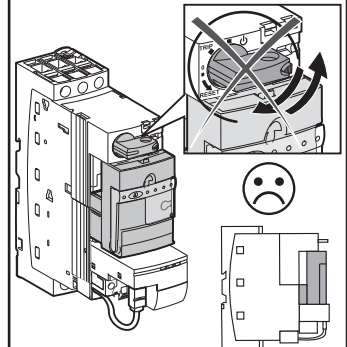
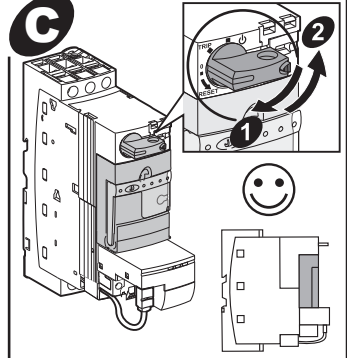

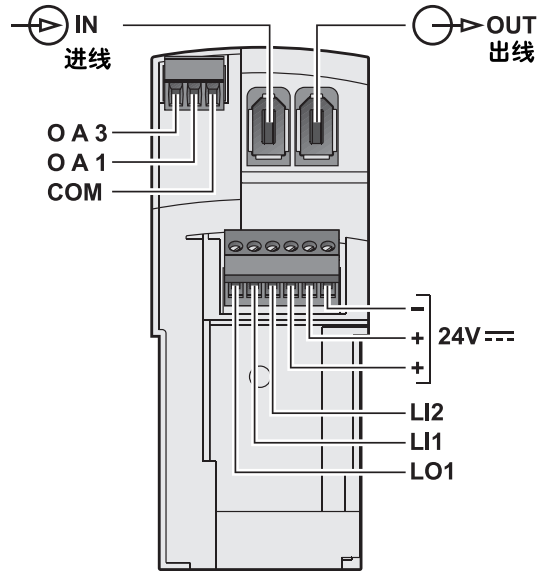
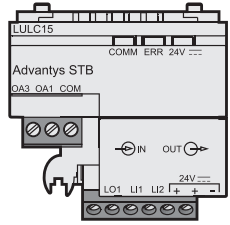

7 mm	Ø2,5 mm	Ø2 mm	0,25 N.m
0.27 in.	Ø0.09 in.	Ø0.07 in.	2.2 lb-in.

0,25...0,5 mm ²	0,14...1 mm ²	0,14...0,75 mm ²	0,14...1 mm ²	0,14...0,5 mm ²
AWG 24...20	AWG 26...18	AWG 26...20	AWG 26...18	AWG 26...20

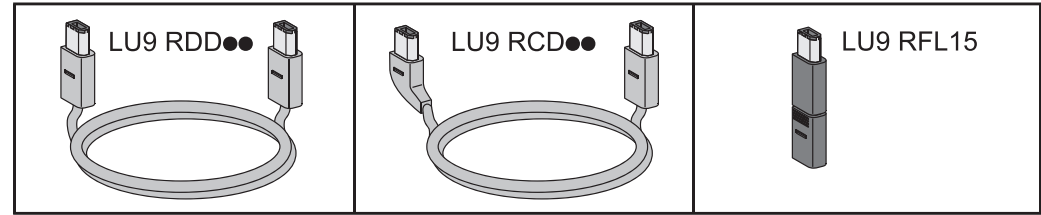

www.schneider-electric.com
 TeSys U LULC15 Advantys STB
 ref : 1744083

