



ARS60-H1K04096

ARS60

ABSOLUTE ENCODERS

SICK
Sensor Intelligence.



Illustration may differ



Ordering information

| Type | Part no. |
|----------------|----------|
| ARS60-H1K04096 | 1031700 |

Other models and accessories → www.sick.com/ARS60

Detailed technical data

Performance

| | |
|---|--|
| Number of steps per revolution (max. resolution) | 4,096 (12 bit) |
| Measuring step | 360° / number of steps |
| Measuring step deviation | 0.005° binary number of steps 0.016° non-binary number of steps |
| Error limits G | 0.035° (binary number of steps) ¹⁾ 0.046° (non-binary number of steps) ¹⁾ |
| Repeatability standard deviation σ_r | 0.005° ²⁾ |

¹⁾ In accordance with DIN ISO 1319-1, position of the upper and lower error limit depends on the installation situation, specified value refers to a symmetrical position, i.e. deviation in upper and lower direction is the same.

²⁾ In accordance with DIN ISO 55350-13; 68.3% of the measured values are inside the specified area.

Interfaces

| | |
|---|---|
| Communication interface | Parallel data world |
| Initialization time | 80 ms ¹⁾ |
| Code type | Binary |
| Code sequence parameter adjustable | CW (clockwise) increasing when viewing the clockwise rotating shaft |
| Measured value backlash | 0.005° |
| Response threshold | 0.003° |

¹⁾ Valid positional data can be read once this time has elapsed.

Electrical data

| | |
|--|---|
| Connection type | Cable, 22-wire, radial, 1.5 m |
| Supply voltage | 10 ... 32 V |
| Operating current | Typ. 90 mA |
| MTTFd: mean time to dangerous failure | 300 years (EN ISO 13849-1) ¹⁾ |
| Switching level of control inputs | Logic H = 0.7 x U _S , Logic L = 0 V ... 0.3 x U _S |

¹⁾ This product is a standard product and does not constitute a safety component as defined in the Machinery Directive. Calculation based on nominal load of components, average ambient temperature 40°C, frequency of use 8760 h/a. All electronic failures are considered hazardous. For more information, see document no. 8015532.

²⁾ Only with shaft stationary (note initialisation time).

| | |
|--------------------------------|--------------------------|
| Actuation of set button | $\geq 100 \text{ ms}^2)$ |
|--------------------------------|--------------------------|

¹⁾ This product is a standard product and does not constitute a safety component as defined in the Machinery Directive. Calculation based on nominal load of components, average ambient temperature 40 °C, frequency of use 8760 h/a. All electronic failures are considered hazardous. For more information, see document no. 8015532.

²⁾ Only with shaft stationary (note initialisation time).

Mechanical data

| | |
|---------------------------------------|--|
| Mechanical design | Solid shaft, Servo flange |
| Shaft diameter | 6 mm |
| Shaft length | 10 mm |
| Weight | Approx. 0.3 kg ¹⁾ |
| Housing material | Aluminum die cast |
| Start up torque | Typ. 0.25 Ncm |
| Operating torque | Typ. 0.2 Ncm |
| Permissible shaft loading | 20 N (radial) 10 N (axial) |
| Operating speed | $\leq 6,000 \text{ min}^{-1}$ with shaft seal $\leq 10,000 \text{ min}^{-1}$ without shaft seal ²⁾ |
| Moment of inertia of the rotor | 48 gcm ² |
| Bearing lifetime | 3.6×10^9 revolutions |
| Angular acceleration | $\leq 500,000 \text{ rad/s}^2$ |

¹⁾ Based on devices with male connector.

²⁾ If the shaft seal has been removed by the customer.

Ambient data

| | |
|--------------------------------------|---|
| EMC | According to EN 61000-6-2 and EN 61000-6-3 ¹⁾ |
| Enclosure rating | IP65, male connector (IEC 60529) ²⁾ IP66, cable (IEC 60529) |
| Permissible relative humidity | 90 % (Condensation not permitted) |
| Operating temperature range | -20 °C ... +85 °C |
| Storage temperature range | -40 °C ... +100 °C, without package |
| Resistance to shocks | 50 g, 11 ms (EN 60068-2-27) |
| Resistance to vibration | 20 g, 10 Hz ... 2,000 Hz (EN 60068-2-6) |

¹⁾ EMC according to the standards quoted is achieved if shielded cables are used.

²⁾ With mating connector fitted.

Classifications

| | |
|---------------------|----------|
| ECLASS 5.0 | 27270502 |
| ECLASS 5.1.4 | 27270502 |
| ECLASS 6.0 | 27270590 |
| ECLASS 6.2 | 27270590 |
| ECLASS 7.0 | 27270502 |
| ECLASS 8.0 | 27270502 |
| ECLASS 8.1 | 27270502 |
| ECLASS 9.0 | 27270502 |

| | |
|-----------------------|----------|
| ECLASS 10.0 | 27270502 |
| ECLASS 11.0 | 27270502 |
| ECLASS 12.0 | 27270502 |
| ETIM 5.0 | EC001486 |
| ETIM 6.0 | EC001486 |
| ETIM 7.0 | EC001486 |
| ETIM 8.0 | EC001486 |
| UNSPSC 16.0901 | 41112113 |

Dimensional drawing (Dimensions in mm (inch))

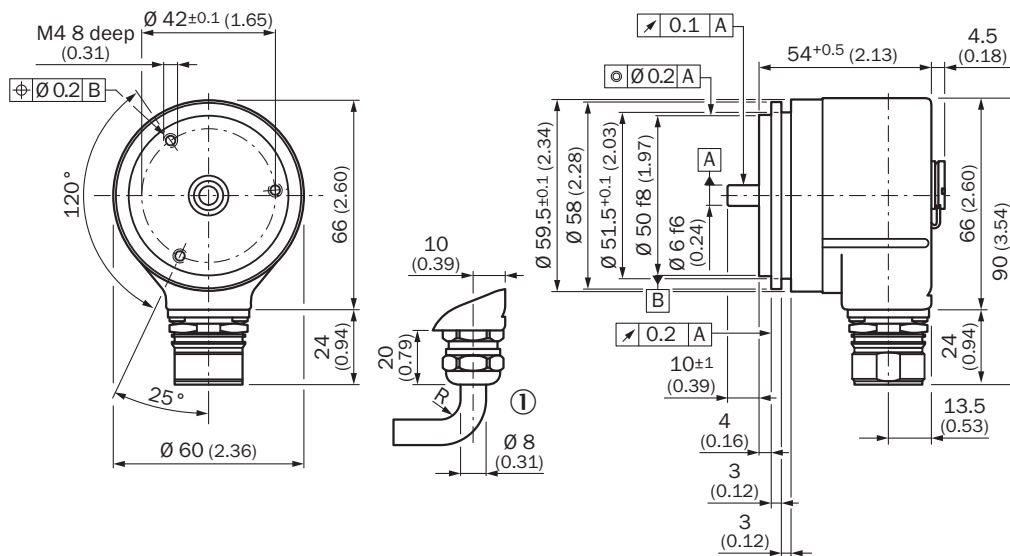

General tolerances according to DIN ISO 2768-mk

① R = min. bending radius 40 mm

PIN assignment

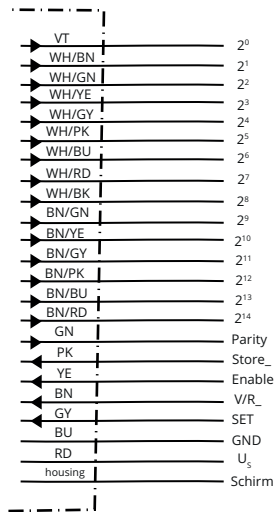





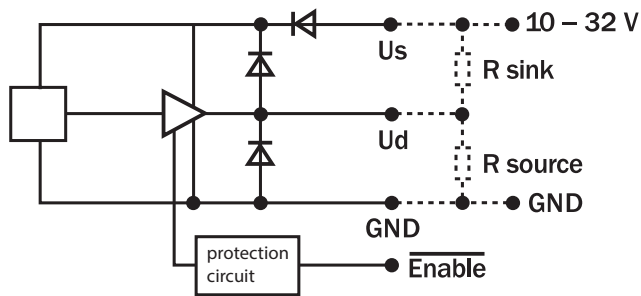

| PIN | Wire colors (cable connection) | Signal Binary | Signal Gray | Signal BCD | |
|-----|--------------------------------|---------------|-------------|-----------------|--|
| 1 | Violet | 2^0 | G^0 | 2^0 v. 10^0 | |
| 2 | White/brown | 2^1 | G^1 | 2^1 v. 10^0 | |
| 3 | White/green | 2^2 | G^2 | 2^2 v. 10^0 | |
| 4 | White/yellow | 2^3 | G^3 | 2^3 v. 10^0 | |
| 5 | White/grey | 2^4 | G^4 | 2^0 v. 10^1 | |
| 6 | White/pink | 2^5 | G^5 | 2^1 v. 10^1 | |
| 7 | White/blue | 2^6 | G^6 | 2^2 v. 10^1 | |
| 8 | White/red | 2^7 | G^7 | 2^3 v. 10^1 | |
| 9 | White/black | 2^8 | G^8 | 2^0 v. 10^2 | |
| 10 | Brown/green | 2^9 | G^9 | 2^1 v. 10^2 | |
| 11 | Brown/yellow | 2^{10} | G^{10} | 2^2 v. 10^2 | |
| 12 | Brown/gray | 2^{11} | G^{11} | 2^3 v. 10^2 | |
| 13 | Brown/pink | 2^{12} | G^{12} | 2^0 v. 10^3 | |
| 14 | Brown/blue | 2^{13} | G^{13} | 2^1 v. 10^3 | |
| 15 | Brown/red | 2^{14} | G^{14} | 2^2 v. 10^3 | |
| 16 | Green | Parity | Parity | | |
| 17 | Pink | Store | | | |
| 18 | Yellow | Enable | | | |
| 19 | Brown | CW/CCW (V/R) | | | |
| * | Gray | SET | | | |
| 20 | Blue | GND | | | |
| 21 | Red | U_s | | | |

Diagrams

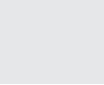

Recommended accessories

Other models and accessories → www.sick.com/ARS60

| | Brief description | Type | Part no. |
|---|---|--------------|----------|
| Other mounting accessories | | | |
|  | Mounting bell for encoder with servo flange, 50 mm spigot, mounting kit included | BEF-MG-50 | 5312987 |
|  | Half-shell servo clamps (2 pcs.) for servo flanges with a 50 mm centering hub | BEF-WG-SF050 | 2029165 |
|  | Servo clamps, large, for servo flange (clamps, eccentric fastener), 3 pcs, without mounting material, without mounting hardware | BEF-WK-SF | 2029166 |
| Plug connectors and cables | | | |
|  | Head A: cable Head B: Flying leads Cable: parallel, PUR, halogen-free, shielded | LTG-2622-MW | 6027532 |
| Shaft adaptation | | | |
|  | Bellows coupling, shaft diameter 6 mm / 6 mm, maximum shaft offset: radial ± 0.25 mm, axial ± 0.4 mm, angular +/- 4°; max. speed 10,000 rpm, -30 °C to +120 °C, max. torque 120 Ncm; material: stainless steel bellows, aluminum hub | KUP-0606-B | 5312981 |
|  | Bellows coupling, shaft diameter 6 mm / 10 mm, maximum shaft offset: radial ± 0.25 mm, axial ± 0.4 mm, angular +/- 4°; max. speed 10,000 rpm, -30 °C to +120 °C, max. torque 120 Ncm; material: stainless steel bellows, aluminum hub | KUP-0610-B | 5312982 |
|  | Spring washer coupling, shaft diameter 6 mm / 10 mm, Maximum shaft offset: radial +/- 0.3 mm, axial +/- 0.4 mm, angular +/- 2.5°; max. speed 12,000 rpm, -10° to +80 °C, max. torque 60 Ncm; material: aluminum flange, glass fiber-reinforced polyamide membrane and hardened steel coupling pin | KUP-0610-F | 5312985 |

SICK AT A GLANCE

SICK is one of the leading manufacturers of intelligent sensors and sensor solutions for industrial applications. A unique range of products and services creates the perfect basis for controlling processes securely and efficiently, protecting individuals from accidents and preventing damage to the environment.

We have extensive experience in a wide range of industries and understand their processes and requirements. With intelligent sensors, we can deliver exactly what our customers need. In application centers in Europe, Asia and North America, system solutions are tested and optimized in accordance with customer specifications. All this makes us a reliable supplier and development partner.

Comprehensive services complete our offering: SICK LifeTime Services provide support throughout the machine life cycle and ensure safety and productivity.

For us, that is “Sensor Intelligence.”

WORLDWIDE PRESENCE:

Contacts and other locations –www.sick.com