



Product designation

Signal tower
Ø70mm/2.75"
8LT7S - Sound
modules

Product type designation

General characteristics

Diameter	mm - inch	70 / 2.75
Supply voltage (AC)	V	24
Supply voltage (DC)	V	24
Colour		Black
IEC degree of protection		IP54
Sound module consumption (AC)	mA	25
Sound module consumption (DC)	mA	25
Sound intensity	dB	90

Mechanical features

Weight	g	240
--------	---	-----

Ambient conditions

Temperature

Operating temperature

min	°C	-20
max	°C	+50

Dimensions

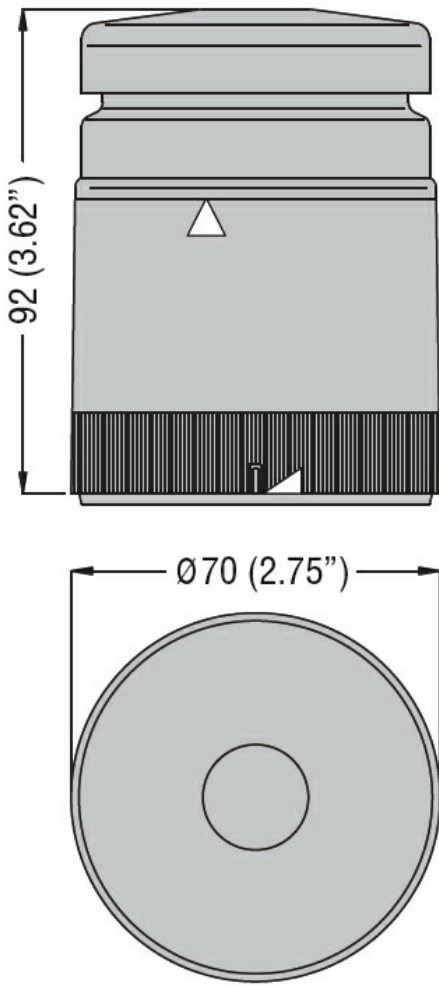

Wiring diagrams

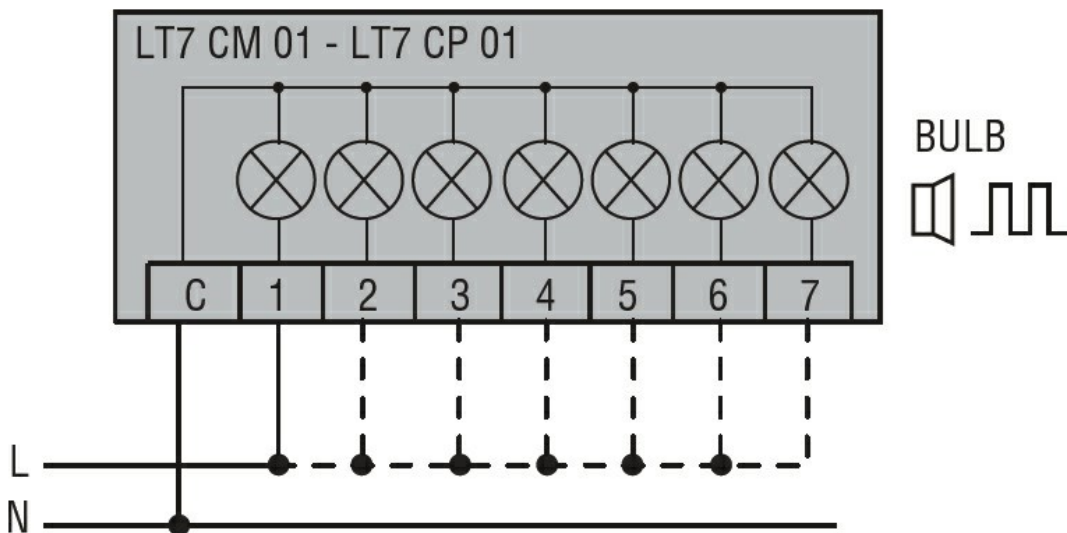

Connect terminals C and 1 as indicated to power the first module. If other modules are fitted, the respective terminals must be connected accordingly.

Certifications and compliance

Compliance

CSA C22.2 n°14

IEC/EN 60947-1

IEC/EN 60947-5-1

UL508

Certificates

cULus

EAC

ETIM classification

ETIM 8.0

EC001261 -
Acoustic module
for signal tower