

Liset 2.0 System

Liset 2.0 is a real multi-purpose lighting system studied to make the best use of the LED technology. Its clean lines and luminous efficiency ensure extraordinary light and colour effects.

Liset 2.0 - DARK LIGHT optics version

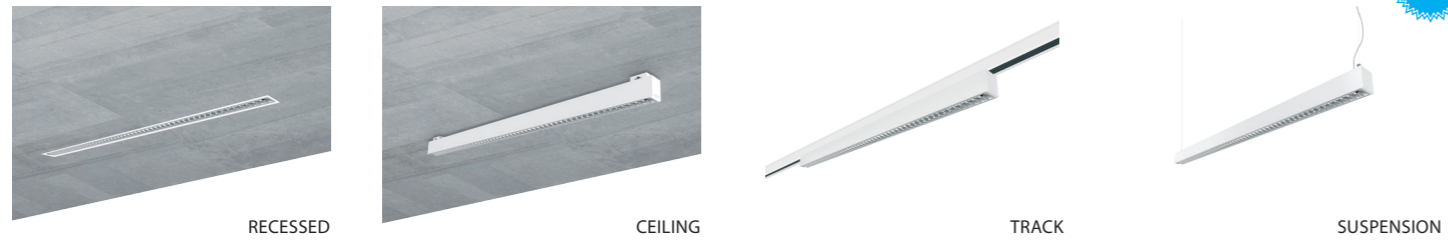

Liset 2.0 - COMFORT optics version

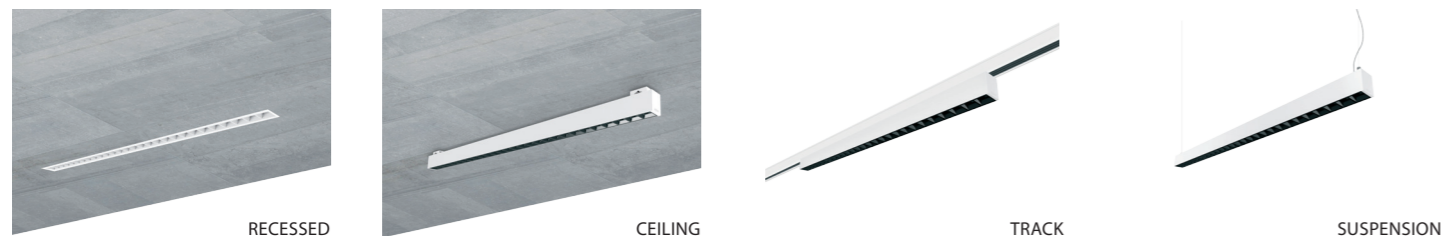

Liset 2.0 - OPAL DIFFUSER version



Liset 2.0 - special compositions with RECESSED lamp

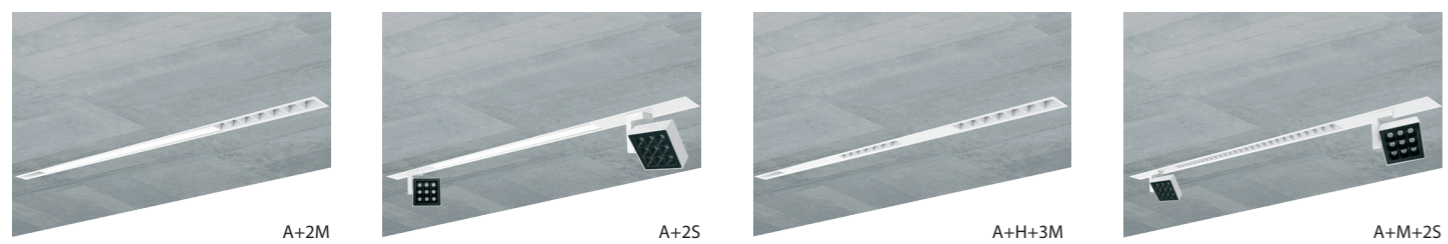

Liset 2.0 - special compositions with CEILING lamp

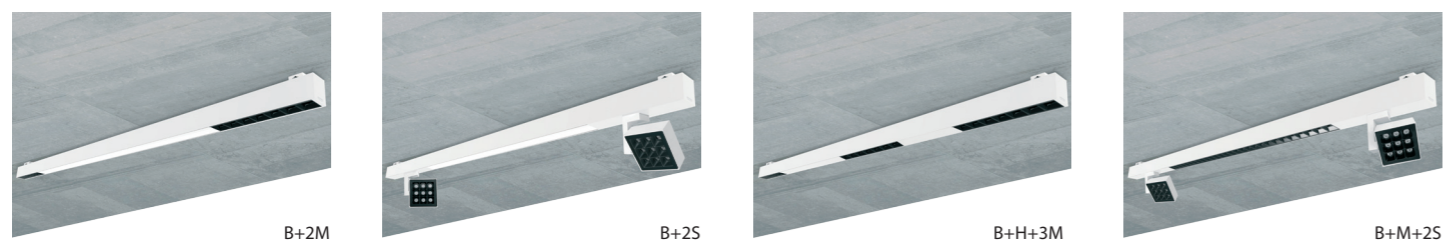

Liset 2.0 - special compositions with SUSPENSION lamp



Liset 2.0 System

The system's extreme flexibility is guaranteed by the numerous compositions that can be made using the angular module to create ALL LIGHT solutions, which can offer uniform lighting of the space and constant visual comfort.

Liset 2.0 - special compositions with SUSPENSION fixtures with acc. "ALL LIGHT" angle module



The system's main feature is the possibility to integrate a wide selection of additional recessed lights, ceiling spotlights and projectors from the Matrix Q series. Thanks to the different combinations of power, lumen, light beams and aesthetic finishes, Liset 2.0 System can perfectly fit into any architectural structure, enhancing both the showroom space and the items on display.

Separate modules - RECESSED DOWNLIGHTS



Separate modules - CEILING SPOTLIGHTS



Floodlights - MATRIX Q DARK series

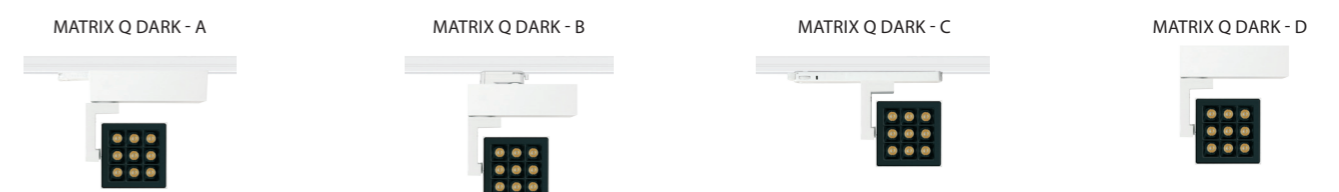

Application with RECESSED lamp

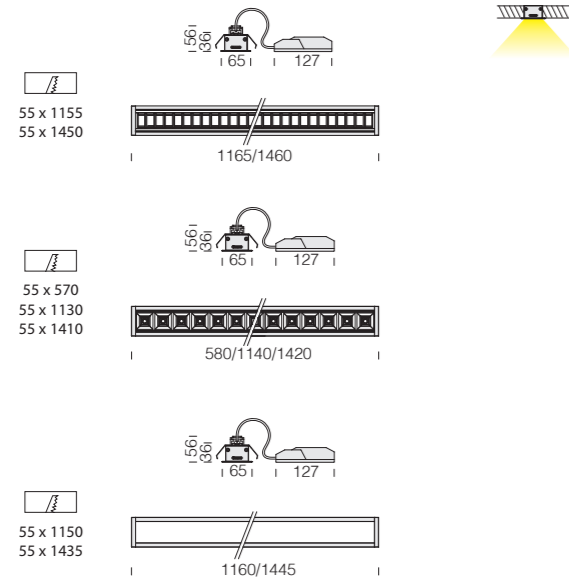

Application with CEILING lamp

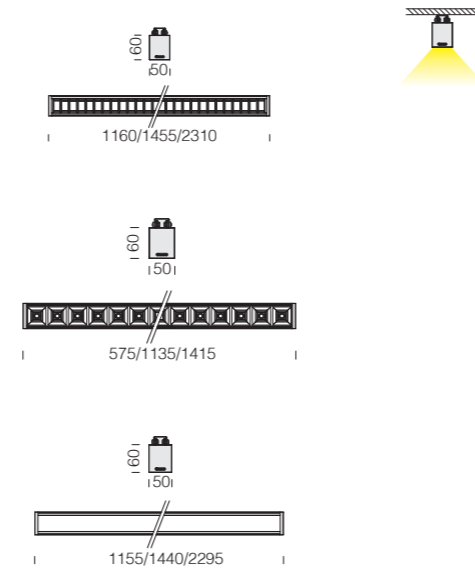

Application with SUSPENSION lamp

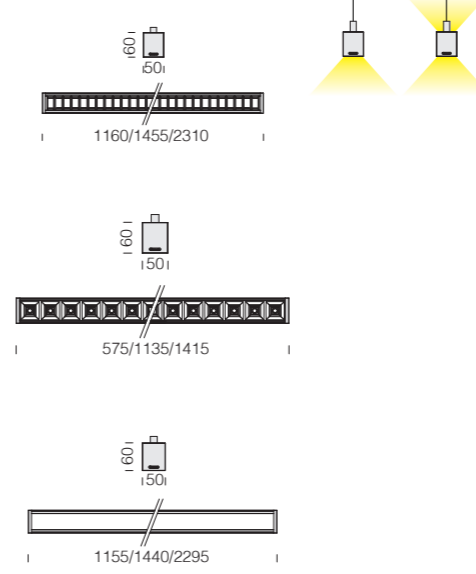

Application with TRACK lamp

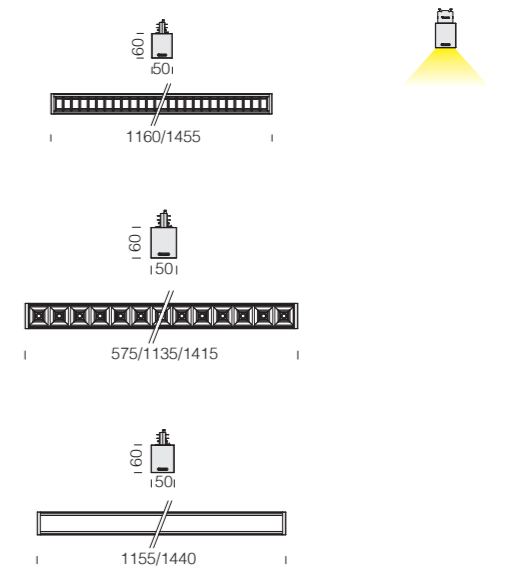

Special compositions with RECESSED lamp

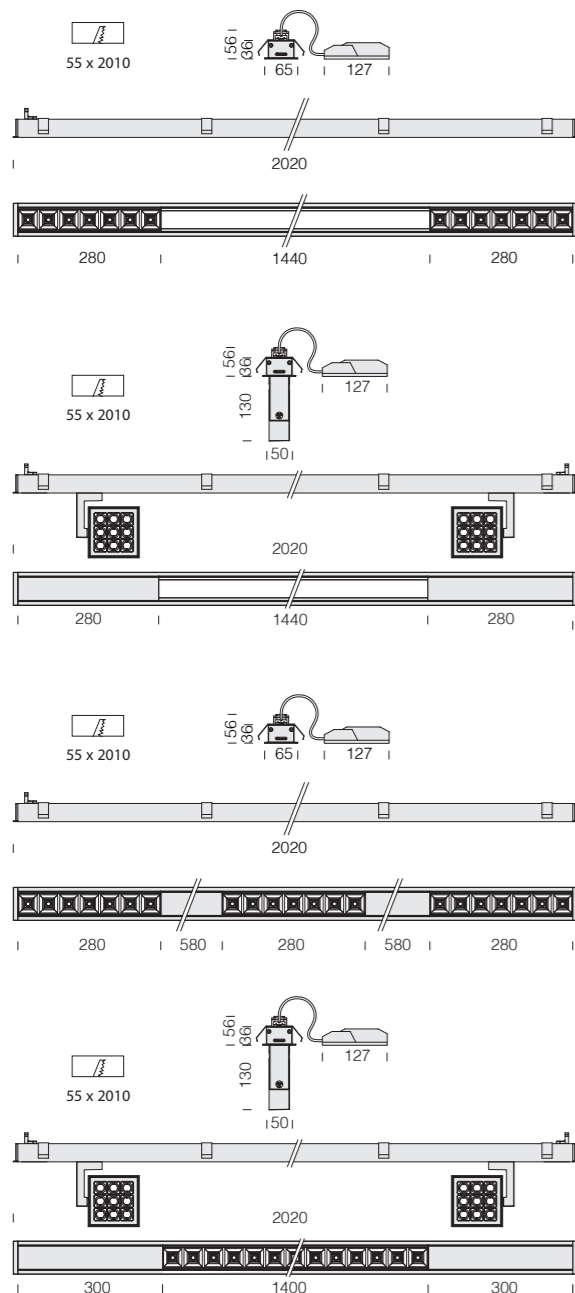

Special compositions with CEILING lamp

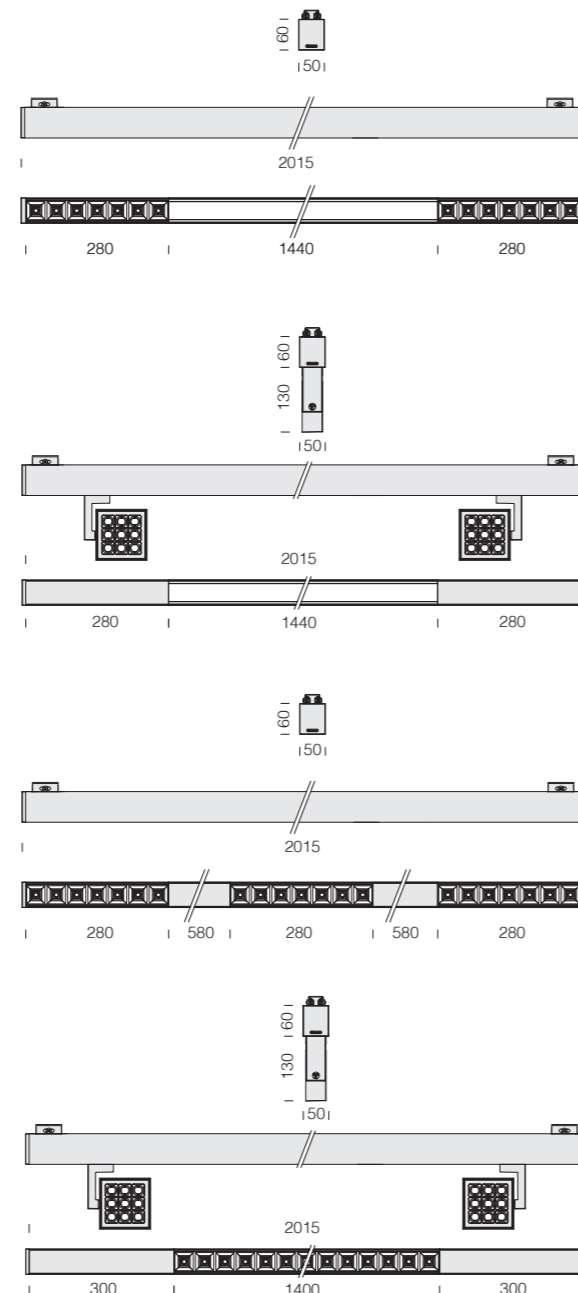

Special compositions with SUSPENSION lamp

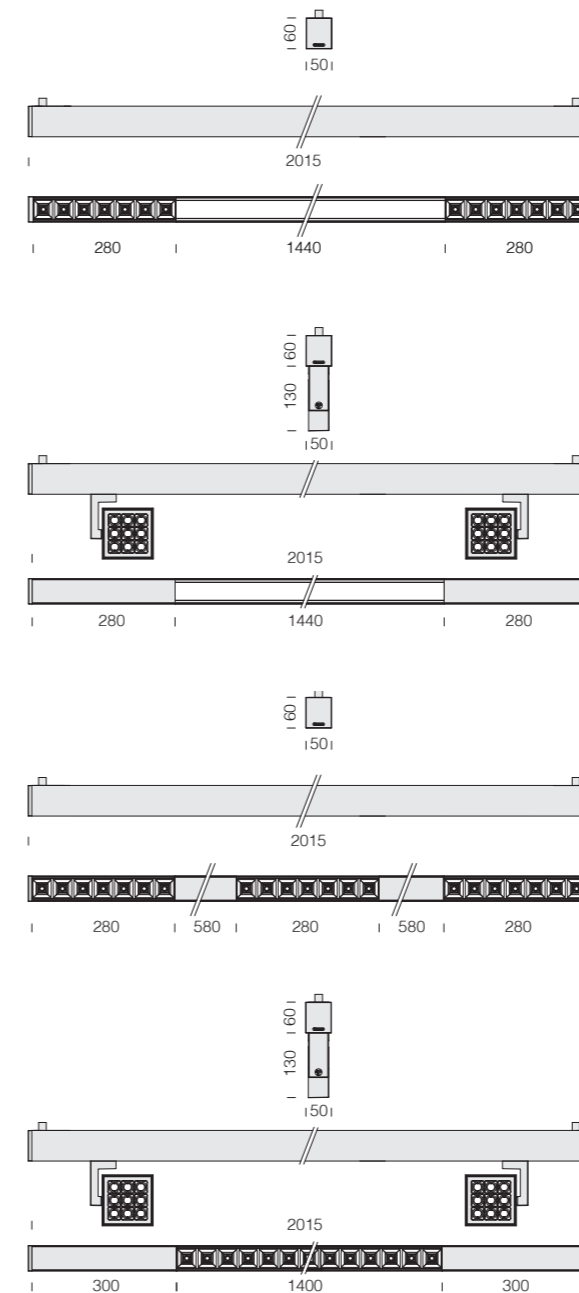

"ALL LIGHT" Angle module	
black	on request
white	on request
It permits angle connection of Liset 2.0.	

