

Part number

# PE 3265 PP



Wall-mounting socket outlet, PLUSO series, 3 poles + N + PE, 6 h (red), 32 A, 380 ÷ 415 V

Product description		Material properties	
<b>Product type</b>	Socket Wall-mounting	<b>Colour</b>	RAL 7035 grey, RAL 3000 red
<b>Series</b>	PE...PP, PLUSO	<b>RoHs conformity</b>	Compliant with exemption 6(c): copper alloy containing up to 4% lead by weight
<b>Connection type</b>	Screw terminal connection	<b>China RoHs - EFUP</b>	50
<b>N. of poles</b>	3 poles + N + 	<b>REACH SVHC substances</b>	Yes Lead
<b>Clock position</b>	6	<b>SCIP number</b>	Ca7de37f-add8-4b77-9861-279c94903ade
Technical data		Approvals / Standards	
<b>Current</b>	32 A	<b>Reference standard</b>	EN 60309-1 and -2
<b>Voltage</b>	380 ÷ 415 V	General ordering information	
<b>IP degree of protection</b>	IP44	<b>EAN13 code</b>	8015747067478
Further technical details		Packaging Information	
<b>Weight</b>	350,00 g	<b>Packaging length</b>	330,00 mm
<b>Operating temperature range (min, max)</b>	-25°C ... +40°C	<b>Packaging height</b>	175,00 mm
		<b>Packaging width</b>	295,00 mm
		<b>Packaging weight</b>	3,90 kg
		<b>Packaging volume</b>	17,04 dm <sup>3</sup>
		<b>Packaging description</b>	Carton box
		<b>Packaging quantity</b>	10 Pcs
		<b>Packaging EAN code</b>	8015747067485

Part number

# PE 3265 PP



Catalogue drawings

(16 / 32A) PE ... PP

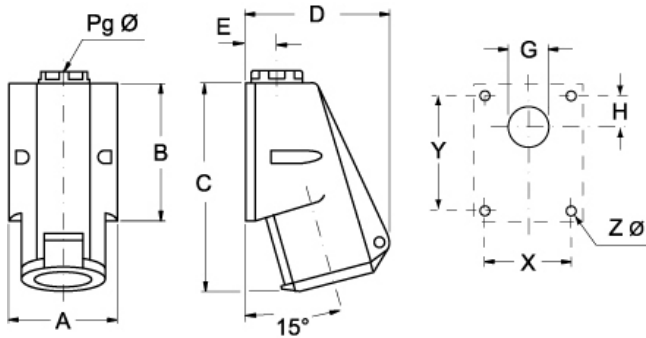

PE ... PP	A	B	C	D	E	G	H	X	Y	Pg Ø	Z Ø
<b>16A</b> 2P+⊕	70	82	126	92	20	Ø22	16	53	65	16	4,5
3P+⊕	70	82	126	92	20	Ø22	16	53	65	16	4,5
3P+N+⊕	70	82	132	106	20	Ø22	16	53	65	16	4,5
<b>32A</b> 2P+⊕	86	104	159	110	24	Ø28	17	61	79	21	6,5
3P+⊕	86	104	159	110	24	Ø28	17	61	79	21	6,5
3P+N+⊕	86	104	159	110	24	Ø28	17	61	79	21	6,5

## Notes

Dimensions shown in mm are not binding and may be changed without notice.

- Compliant with EN 60309-1 and -2
- Enclosure, insert and spring lid in insulating, thermoplastic, self-extinguishing material
- RAL 7035 grey enclosure, spring lid colour coded according to the operating voltage
- PE...PP types (IP44), spring lid, entry with threaded grommet (replaceable with a cable gland)
- PEW...PP types (IP67), spring lid with locking ring and gasket, entry with cable gland
- Terminals with retained screws
- 63A, 125A: with pilot contact
- Nickel-plated contacts, available on request for 16A and 32A (standard on 63A and 125A). For the code of products with nickel-plated contacts (socket holes, plug pins), add "N" to the pre-code of the corresponding standard product code; for example: PE becomes PEN and PEW becomes PEWN.
- 125A: with terminal block for the anchoring of incoming cables, already connected to socket
- IP44 and IP67 degrees of protection (EN 60529)