

# EDWARD WALL SWITCHED

astro

## GENERAL

|                           |                      |
|---------------------------|----------------------|
| LOCATION:                 | Interior             |
| CLASS:                    | CE (Class I)         |
| IP RATING:                | IP20                 |
| BATHROOM ZONE:            | -                    |
| DRIVER REQUIRED:          | No                   |
| INSTALLATION ORIENTATION: | Wall Mount           |
| MAIN MATERIAL:            | Metal - Zinc         |
| DIMENSIONS (mm):          | H: 276 W: 110 D: 262 |
| CUT OUT HOLE :            | -                    |
| RECESS DEPTH (mm):        | -                    |
| FIRE RATING:              | -                    |
| CABLE LENGTH (mm):        | -                    |
| GROSS WEIGHT (kg):        | 1.3                  |

## LAMP

|                                |                    |
|--------------------------------|--------------------|
| LIGHT SOURCE:                  | LED E27/ES         |
| WATTAGE:                       | 12W Max            |
| RECOMMENDED LAMP:              | 12W Max LED E27/ES |
| LAMP INCLUDED:                 | No                 |
| MAXIMUM LAMP LENGTH (mm):      | -                  |
| LUMINOUS FLUX (lm):            | 118                |
| COLOUR TEMP (K):               | Lamp Dependent     |
| CRI (Ra):                      | Lamp Dependent     |
| MACADAM ELLIPSE:               | Lamp Dependent     |
| TILT ADJUSTABLE ANGLE (°):     | 90                 |
| ROTATION ADJUSTABLE ANGLE (°): | 330                |
| LIFETIME (hrs):                | Lamp Dependent     |
| BEAM ANGLE (°):                | Lamp Dependent     |

## ELECTRICAL

|                             |                |
|-----------------------------|----------------|
| SWITCHED:                   | Yes            |
| DIMMABLE:                   | No             |
| DIMMING METHOD:             | -              |
| SUPPLY FREQUENCY (Hz):      | -              |
| DRIVER/BALLAST VOLTAGE (V): | -              |
| DRIVER LIFETIME (hrs):      | -              |
| EFFICACY (lm/W):            | Lamp Dependent |

## ADDITIONAL INFORMATION:

|                          |  |
|--------------------------|--|
| SHADE INCLUDED:          | Shade Sold Separately                        |
| SHADE/DIFFUSER MATERIAL: | -  |
| SHADE/DIFFUSER FINISH    | -  |
| F MARK:                  | Suitable for mounting on flammable materials |



CODE: 1441013  
FINISH: MATT BLACK

TO MAINTAIN THIS PRODUCT TO ITS BEST CONDITION, PLEASE VIEW OUR CARE AND CLEANING GUIDE ON THE SUPPORT SECTION OF THE ASTRO WEBSITE.

Pour entretenir au mieux ce produit, veuillez consulter notre guide d'entretien et de nettoyage, dans la rubrique d'aide sur le site Web d'Astro.

Um dieses Produkt im besten Zustand zu erhalten, beachten Sie bitte unseren Leitfaden zu Pflege und Reinigung im Abschnitt „Support“ auf der Astro-Website.

Per mantenere questo prodotto nelle sue migliori condizioni, consultare la nostra guida per la manutenzione e la pulizia nella sezione dedicata all'assistenza del sito Web Astro.

## Without Shade

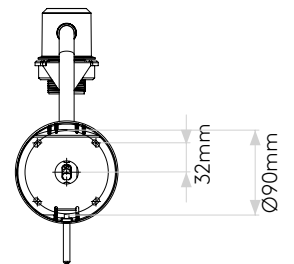
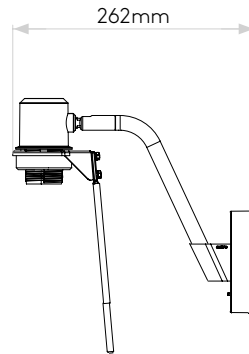
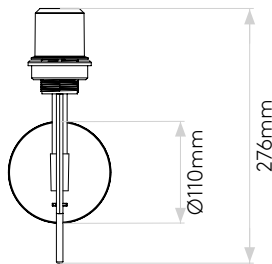
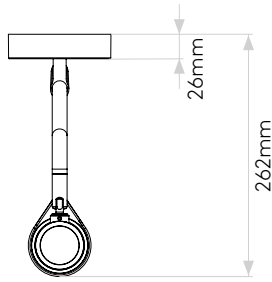

## With Tapered Drum 155 Shade

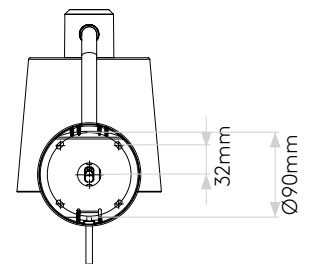
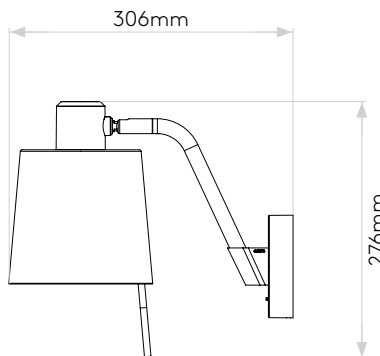
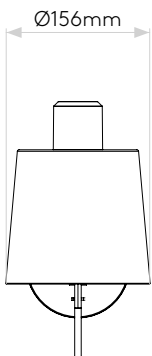
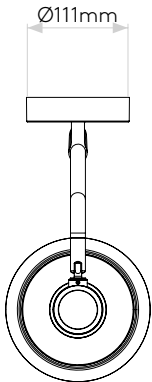

Please note that some dimensions may vary slightly due to manufacturing tolerances, this includes cable entry and fixing holes

Veillez noter que certaines dimensions peuvent varier légèrement en raison des tolérances de fabrication, y compris l'entrée de câble et les trous de fixation.

Bitte beachten Sie, dass die Maße Fertigungstoleranzen unterliegen und daher in geringem Umfang von der angegebenen Größe abweichen können. Dies gilt auch für Kabeingänge und Befestigungslöcher.

Si prega notare che possono esserci piccole variazioni in alcune dimensioni dovute alle tolleranze di produzione, queste includono l'ingresso del cavo e i fori di fissaggio.