



WL4S-3W1132

W4

MINIATURE PHOTOELECTRIC SENSORS

**SICK**  
Sensor Intelligence.



Illustration may differ



### Ordering information

| Type        | Part no. |
|-------------|----------|
| WL4S-3W1132 | 1042083  |

Other models and accessories → [www.sick.com/W4](http://www.sick.com/W4)

### Detailed technical data

#### Features

|                                    |                                       |
|------------------------------------|---------------------------------------|
| <b>Functional principle</b>        | Photoelectric retro-reflective sensor |
| <b>Functional principle detail</b> | Autocollimation                       |
| <b>Sensing range max.</b>          | 0 m ... 5 m <sup>1)</sup>             |
| <b>Sensing range</b>               | 0 m ... 3 m <sup>1)</sup>             |
| <b>Polarisation filters</b>        | Yes                                   |
| <b>Emitted beam</b>                |                                       |
| Light source                       | PinPoint LED <sup>2)</sup>            |
| Type of light                      | Visible red light                     |
| Light spot size (distance)         | Ø 45 mm (1.5 m)                       |
| <b>Key LED figures</b>             |                                       |
| Wave length                        | 650 nm                                |
| <b>Adjustment</b>                  | Single teach-in button                |

<sup>1)</sup> Reflector PL80A.

<sup>2)</sup> Average service life: 100,000 h at T<sub>J</sub> = +25 °C.

#### Safety-related parameters

|                                     |             |
|-------------------------------------|-------------|
| <b>MTTF<sub>D</sub></b>             | 1,530 years |
| <b>DC<sub>avg</sub></b>             | 0 %         |
| <b>T<sub>M</sub> (mission time)</b> | 20 years    |

## Electrical data

|  |   |
|--|---|
| <b>Supply voltage <math>U_B</math></b> | 10 V DC ... 30 V DC <sup>1)</sup>                     |
| <b>Ripple</b>                          | < 5 V <sub>pp</sub> <sup>2)</sup>                     |
| <b>Current consumption</b>             | 20 mA <sup>3)</sup>                                   |
| <b>Protection class</b>                | III   |
| <b>Digital output</b>                  |   |
| Type                                   | NPN   |
| Switching mode                         | Dark switching  |
| Output current $I_{max}$               | ≤ 100 mA  |
| Response time                          | < 0.5 ms <sup>4)</sup>                                |
| Switching frequency                    | 1,000 Hz <sup>5)</sup>                                |
| <b>Circuit protection</b>              | A <sup>6)</sup><br>C <sup>7)</sup><br>D <sup>8)</sup> |

<sup>1)</sup> Limit values.

<sup>2)</sup> May not exceed or fall below  $U_V$  tolerances.

<sup>3)</sup> Without load.

<sup>4)</sup> Signal transit time with resistive load.

<sup>5)</sup> With light/dark ratio 1:1.

<sup>6)</sup> A =  $V_S$  connections reverse-polarity protected.

<sup>7)</sup> C = interference suppression.

<sup>8)</sup> D = outputs overcurrent and short-circuit protected.

## Mechanical data

|                               |                                  |
|-------------------------------|----------------------------------|
| <b>Housing</b>                | Rectangular                      |
| <b>Design detail</b>          | Slim                             |
| <b>Dimensions (W x H x D)</b> | 12.2 mm x 41.8 mm x 17.3 mm      |
| <b>Connection</b>             | Cable, 4-wire, 2 m <sup>1)</sup> |
| <b>Connection detail</b>      |                                  |
| Conductor size                | 0.14 mm <sup>2</sup>             |
| Cable diameter                | Ø 3.4 mm                         |
| Length of cable (L)           | 2 m <sup>1)</sup>                |
| <b>Material</b>               |                                  |
| Housing                       | Plastic, ABS                     |
| Front screen                  | Plastic, PMMA                    |
| Cable                         | PVC                              |
| <b>Weight</b>                 | 30 g                             |

<sup>1)</sup> Do not bend below 0 °C.

## Ambient data

|                                      |                              |
|--------------------------------------|------------------------------|
| <b>Enclosure rating</b>              | IP67<br>IP66                 |
| <b>Ambient operating temperature</b> | -40 °C ... +60 °C            |
| <b>Ambient temperature, storage</b>  | -40 °C ... +75 °C            |
| <b>UL File No.</b>                   | NRKH.E181493 & NRKH7.E181493 |

### Classifications

|                       |          |
|-----------------------|----------|
| <b>ECLASS 5.0</b>     | 27270902 |
| <b>ECLASS 5.1.4</b>   | 27270902 |
| <b>ECLASS 6.0</b>     | 27270902 |
| <b>ECLASS 6.2</b>     | 27270902 |
| <b>ECLASS 7.0</b>     | 27270902 |
| <b>ECLASS 8.0</b>     | 27270902 |
| <b>ECLASS 8.1</b>     | 27270902 |
| <b>ECLASS 9.0</b>     | 27270902 |
| <b>ECLASS 10.0</b>    | 27270902 |
| <b>ECLASS 11.0</b>    | 27270902 |
| <b>ECLASS 12.0</b>    | 27270902 |
| <b>ETIM 5.0</b>       | EC002717 |
| <b>ETIM 6.0</b>       | EC002717 |
| <b>ETIM 7.0</b>       | EC002717 |
| <b>ETIM 8.0</b>       | EC002717 |
| <b>UNSPSC 16.0901</b> | 39121528 |

### Connection type

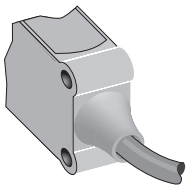

### Connection diagram

Cd-107

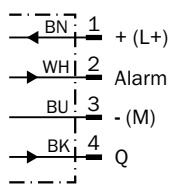

### Light spot size

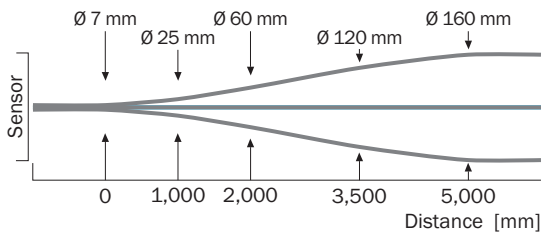

### Sensing range diagram

WL4S-3, WLG4S-3, 5 m

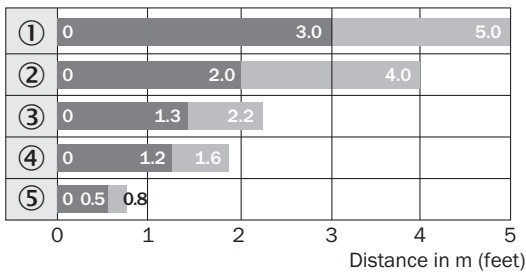

■ Sensing range      ■ Sensing range max.

- ① Reflector PL80A
- ② Reflector PL40A
- ③ Reflector PL20A
- ④ PL10F reflector
- ⑤ Reflective tape REF-IRF-56

### Dimensional drawing (Dimensions in mm (inch))

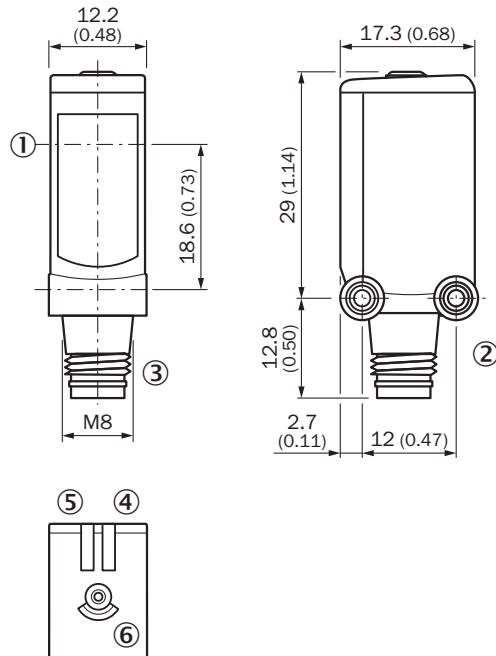

WL4S-3, WLG4S-3, single teach-in button



- ① Center of optical axis
- ② Threaded mounting hole M3
- ③ Connection
- ④ LED indicator green: Supply voltage active
- ⑤ Orange LED indicator: status of received light beam
- ⑥ Teach-in button

### Recommended accessories

Other models and accessories → [www.sick.com/W4](http://www.sick.com/W4)

|   | Brief description   | Type       | Part no. |
|---|---|------------|----------|
| Mounting brackets and plates  |   |            |          |
|  | Mounting bracket for wall mounting, Stainless steel 1.4571, mounting hardware included  | BEF-W4-A   | 2051628  |
| Plug connectors and cables  |   |            |          |
|  | <ul style="list-style-type: none"> <li>• <b>Connection type head A:</b> Male connector, M8, 4-pin, straight</li> <li>• <b>Description:</b> Unshielded</li> <li>• <b>Connection systems:</b> Screw-type terminals</li> <li>• <b>Permitted cross-section:</b> 0.14 mm<sup>2</sup> ... 0.5 mm<sup>2</sup></li> </ul> | STE-0804-G | 6037323  |
| Reflectors  |   |            |          |
|  | Fine triple reflector, screw connection, suitable for laser sensors, 20 mm x 32 mm, PM-MA/ABS, Screw-on, 2 hole mounting  | PL10F      | 5311210  |

## SICK AT A GLANCE

SICK is one of the leading manufacturers of intelligent sensors and sensor solutions for industrial applications. A unique range of products and services creates the perfect basis for controlling processes securely and efficiently, protecting individuals from accidents and preventing damage to the environment.

We have extensive experience in a wide range of industries and understand their processes and requirements. With intelligent sensors, we can deliver exactly what our customers need. In application centers in Europe, Asia and North America, system solutions are tested and optimized in accordance with customer specifications. All this makes us a reliable supplier and development partner.

Comprehensive services complete our offering: SICK LifeTime Services provide support throughout the machine life cycle and ensure safety and productivity.

For us, that is “Sensor Intelligence.”

## WORLDWIDE PRESENCE:

Contacts and other locations –[www.sick.com](http://www.sick.com)