

TeSys[®] U LUTM Controller User's Manual

03/2009



Schneider Electric assumes no responsibility for any errors that may appear in this document. If you have any suggestions for improvements or amendments or have found errors in this publication, please notify us.

No part of this document may be reproduced in any form or by any means, electronic or mechanical, including photocopying, without express written permission of Schneider Electric.

All pertinent state, regional, and local safety regulations must be observed when installing and using this product. For reasons of safety and to help ensure compliance with documented system data, only the manufacturer should perform repairs to components.

When devices are used for applications with technical safety requirements, the relevant instructions must be followed.

Failure to use Schneider Electric software or approved software with our hardware products may result in injury, harm, or improper operating results.

Failure to observe this information can result in injury or equipment damage.

© 2009 Schneider Electric. All rights reserved.

Table of Contents



	Safety Information	5
	About the Book	7
Chapter 1	LUTM Controller Setup	9
	Safety Instructions	10
	Presentation of the LUTM Controller	11
	Description of the LUTM Controller	12
	Presentation of the Power Unit	16
	Assembly of the LUTM controller	17
	Connection	18
	Starting Up the LUTM Controller	22
Chapter 2	Operation of the LUTM controller	25
	Operating Modes	26
	Fault Management and Reset Mode	32
Chapter 3	Technical characteristics of the LUTM controller	37
	Technical Characteristics	37
Glossary	39
Index	41

Safety Information

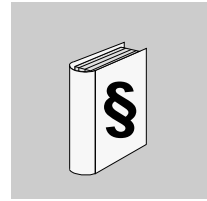

Important Information

NOTICE

Read these instructions carefully, and look at the equipment to become familiar with the device before trying to install, operate, or maintain it. The following special messages may appear throughout this documentation or on the equipment to warn of potential hazards or to call attention to information that clarifies or simplifies a procedure.



L'apposition de ce symbole à un panneau de sécurité Danger ou Avertissement signale un risque électrique pouvant entraîner des lésions corporelles en cas de non-respect des consignes.



Ceci est le symbole d'une alerte de sécurité. Il vous avertit d'un risque de blessures corporelles. Respectez scrupuleusement les consignes de sécurité associées à ce symbole pour éviter de vous blesser ou de mettre votre vie en danger.

DANGER

DANGER indique une situation immédiatement dangereuse qui, si elle n'est pas évitée, **entraînera** la mort ou des blessures graves.

AVERTISSEMENT

L'indication **AVERTISSEMENT** signale une situation potentiellement dangereuse et susceptible **d'entraîner** la mort ou des blessures graves.

ATTENTION

L'indication **ATTENTION** signale une situation potentiellement dangereuse et susceptible **d'entraîner des** blessures d'ampleur mineure à modérée.

ATTENTION

L'indication **ATTENTION**, utilisée avec le symbole d'alerte de sécurité, signale une situation potentiellement dangereuse et susceptible **d'entraîner des** dommages aux équipements.

PLEASE NOTE

Electrical equipment should be installed, operated, serviced, and maintained only by qualified personnel. No responsibility is assumed by Schneider Electric for any consequences arising out of the use of this material.

A qualified person is one who has skills and knowledge related to the construction and operation of electrical equipment and the installation, and has received safety training to recognize and avoid the hazards involved.

About the Book

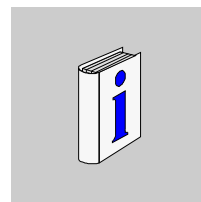

At a Glance

Document Scope

This manual describes the setup, functions and operation of the TeSys U LUTM controller.
Area of application: installers, design office, maintenance staff.

Validity Note

The availability of some functions depends on the TeSys U LUTM controller software version.

Related Documents

Title of Documentation	Reference Number
LU•B/LU•S• TeSys U Starters - Instruction Sheet	1629984
LUTM• Tesys U Controller - Instruction Sheet	1743236
LUCM/LUCMT Multifunction Control Units - User's Manual	1743237
LUCM/LUCMT/LUCBT/LUCDT Control Units - Instruction Sheet	AAV40504

You can download these technical publications and other technical information from our website at www.schneider-electric.com.

User Comments

We welcome your comments about this document. You can reach us by e-mail at techcomm@schneider-electric.com.

LUTM Controller Setup



What's in this Chapter?

This chapter contains the following topics:

Topic	Page
Safety Instructions	10
Presentation of the LUTM Controller	11
Description of the LUTM Controller	12
Presentation of the Power Unit	16
Assembly of the LUTM controller	17
Connection	18
Starting Up the LUTM Controller	22

Safety Instructions

General Instructions

WARNING

HAZARDOUS OPERATION

These devices must be installed, configured and used by qualified staff only.

Users must follow all current instructions, standards and regulations.

Check the function settings before starting the motor.

Do not downgrade or modify these devices.

Failure to follow these instructions can result in death, serious injury, or equipment damage.

WARNING

SETTING ERROR

Data relating to motor-starter states and load current values must not be used to control safety devices and emergency stops.

Check the function settings before starting the motor.

Failure to follow these instructions can result in death, serious injury, or equipment damage.

Presentation of the LUTM Controller

Aim of the Product

When used with a short-circuit protection device and a contactor, the LUTM controller creates a motor starter that provides protection against overloads and permits control of motor starter functions. Functions include:

- Direct control via its output relays of the coils of reversing and non-reversing contactors up to 250 kW (F500)
- Control of the coils of reversing and non-reversing contactors above 250 kW using an interface relay between the controller output relays and the contactor coils
- Monitoring and protection of nominal currents up to 800 A

NOTE: In an installation containing TeSys U starter-controllers and TeSys U controllers, motor-starter management is identical from the point of view of the PLC.

Conditions of Use

Irrespective of the nominal current value of the motor it is supposed to control, the LUTM controller is always used with external current transformers in which:

- The secondary is at 1 A nominal.
- The primary is selected according to the motor nominal current.

Typical Composition

Typical composition of a motor-starter unit

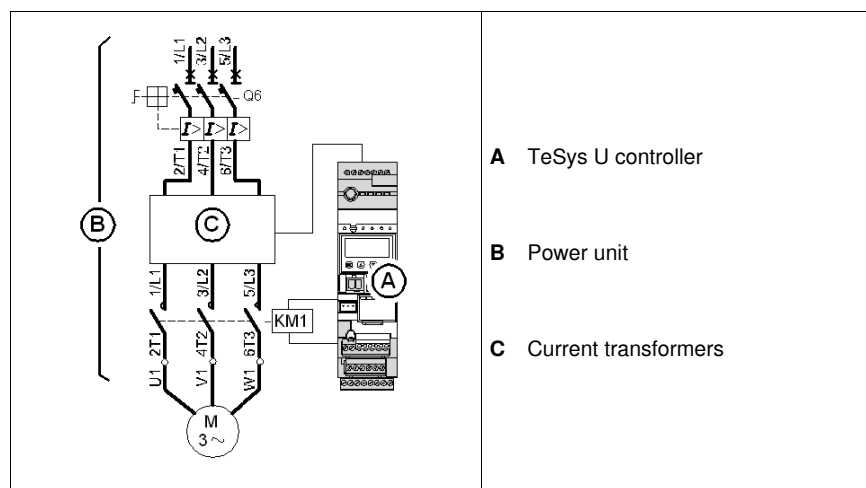

Description of the LUTM Controller

The LUTM controller consists of:

- A controller base
- An advanced or multifunction control unit
- And, if required, a function module or communication module

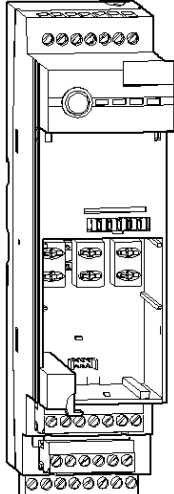
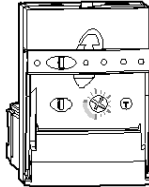
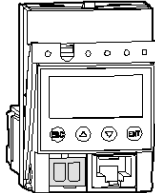
LUTM-•BL Controller Base	LUCBT1BL or LUCDT1BL Advanced Control Unit	LUCMT1BL Multifunction Control Unit
		
<p>Module (Optional)</p> <ul style="list-style-type: none"> • Function module: <ul style="list-style-type: none"> - LUFV2 motor-load indication - LUFW10 thermal-overload alarm • Communication module: <ul style="list-style-type: none"> - Modbus LULC032-033 - CANopen LULC08 - DeviceNet LULC09 - Advantys STB LULC15 		



Configuration

There are two main configurations:

- Controller **without** communication module
(Protection of a motor > 32A, stand-alone operation)
- Controller **with** communication module
(Control and protection of a motor in a control panel)

Composition of a Controller WITHOUT Communication

Five possible combinations.

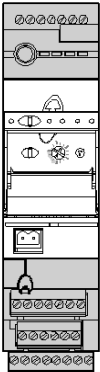
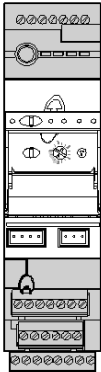
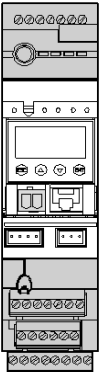
LUTM-•BL Controller Base		Control Unit		
Advanced LUCBT1BL/LUCDT1 BL	Multifunction LUCMT1BL	Advanced LUCBT1BL/LUCDT1BL		Multifunction LUCMT1BL
				
---	---	Function module (optional)		
		LUFW10	LUFV2	

Composition of a Controller WITH Communication

Two possible combinations.

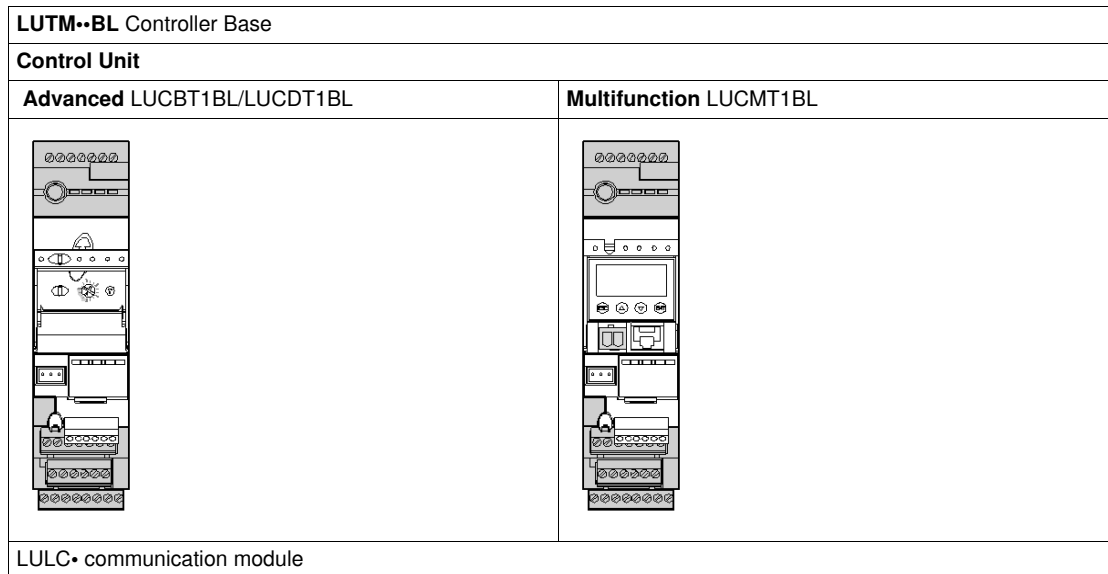

LUTM••BL Controller Base

There are two controller bases depending on the model of contactor to be controlled: **LUTM10BL** and **LUTM20BL**.

Table of LUTM/contactor combinations.

LUTM10BL		LUTM20BL	
Voltage	Contactor	Voltage	Contactor
24 <=> 250 V ~	TeSys d	24 <=> 250 V ~	TeSys d
24 V ---	TeSys d 09 <=> 95	24 V ---	TeSys d 09 <=> 95
		110 <=> 250 V ~	TeSys f

Composition of the LUTM••BL Controller Base

Components in the controller base.

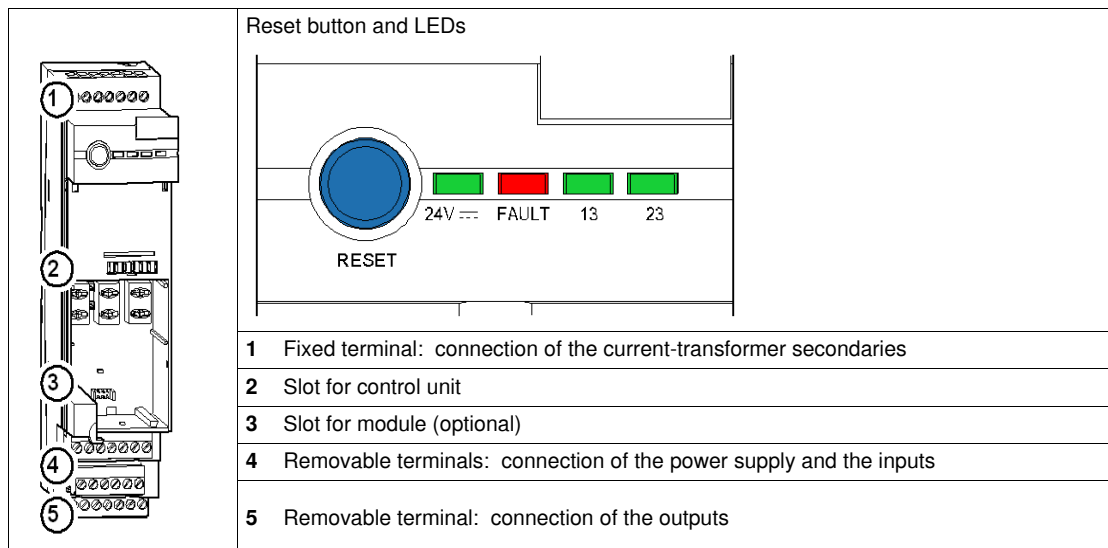

LEDs on the LUTM-BL Controller Base

Description of the various states of the LEDs on the controller base.

Light-Emitting Diodes		Comment
Green "24V ---" LED	Red "FAULT" LED	
On	Off	Normal operation
Off	On or off	Possible fault
Flashing		See <i>State of the LEDs on the Controller Base, page 33</i>

Light-Emitting Diodes		Comment
Green "13" LED	On	
	Off	Possible fault
Green "23" LED	Off	See <i>State of the LEDs on the Controller Base, page 33</i>
	On	Contact for output 23 "closed"

LUC-T Advanced Control Unit

Functions performed by the advanced control unit.

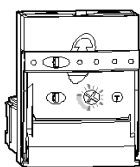
	<ul style="list-style-type: none"> ● Protection: <ul style="list-style-type: none"> - against overloads, class 10 (LUCBT1BL) or 20 (LUCDT1BL) - against loss of phase and phase imbalance ● Current setting on front panel ● Thermal trip test ● Reset: <ul style="list-style-type: none"> - manual - remote or automatic in conjunction with a function module or a communication module ● Display (motor load) with a function module or a communication module ● Alarm: with a function module (e.g., LUFW10) <p><i>Setting the Advanced Control Unit, page 22</i></p>
------------------------------------------------------------------------------------	---------------------------------------------------------------------------------------------------------------------------------------------------------------------------------------------------------------------------------------------------------------------------------------------------------------------------------------------------------------------------------------------------------------------------------------------------------------------------------------------------------------------------------------------------------------------------------------------------------------------------------------------------------------------------------------------------------------------------------------------------------------

LUCMT Multifunction Control Unit

Functions performed by the multifunction control unit.

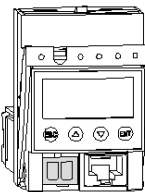
	<ul style="list-style-type: none"> ● Protection ● Alarm ● Diagnostics <p>These three functions can be configured and monitored.</p> <ul style="list-style-type: none"> ● Reset: <ul style="list-style-type: none"> - manual - remote or automatic <p><i>Refer to the documentation for this product.</i></p>
-------------------------------------------------------------------------------------	-------------------------------------------------------------------------------------------------------------------------------------------------------------------------------------------------------------------------------------------------------------------------------------------------------------------------------------------------------------------------------------------------------------------

LUFW10 Function Module

Functions performed by the "Alarm on thermal overload" function module.

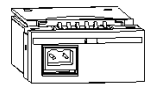
	<ul style="list-style-type: none"> ● Determination of the motor thermal state ● Alarm signaling for: <ul style="list-style-type: none"> - improving the performance of the controlled motor - anticipating complete stop due to a thermal overload ● Avoiding, by load shedding, interruptions in use due to tripping on overloads. <p>All the data processed by this module can be accessed on discrete contacts.</p>
-------------------------------------------------------------------------------------	--------------------------------------------------------------------------------------------------------------------------------------------------------------------------------------------------------------------------------------------------------------------------------------------------------------------------------------------------------------------------------------------------------------------------------------------------------------------------------------------------------------

NOTE: Can only be used with the advanced control unit.

LUFV2 Function Module

Functions performed by the "Indication of the motor load (analog)" function module.

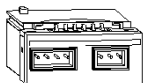
	<ul style="list-style-type: none"> • Determination of the state of the motor load (I mean/FLA) <ul style="list-style-type: none"> - I mean = mean value of the rms currents in all 3 phases - FLA = value of the setting current <p>It delivers an analog signal of 4 to 20 mA (0% to 200%) proportional to the motor load.</p>
-----------------------------------------------------------------------------------	-----------------------------------------------------------------------------------------------------------------------------------------------------------------------------------------------------------------------------------------------------------------------------------------------------------------------------------------------------------------------------------

NOTE: Can be used with an advanced or multifunction control unit.

LULC- Communication Module

Functions performed by the communication module.

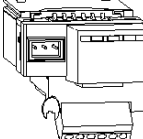
	<ul style="list-style-type: none"> • Network connection of the LUTM controller • Alarm • Diagnostics <p>Processed data is exchanged via the serial link. <i>Refer to the documentation for this product.</i></p>
-----------------------------------------------------------------------------------	-------------------------------------------------------------------------------------------------------------------------------------------------------------------------------------------------------------------------------------------------------

The protection and control data available depend on the control unit with which the communication module is used.

Data - Commands	Control Unit	
	Advanced LUCBT/CDT1BL	Multifunction LUCMT1BL
Start and stop commands	X	X
Status (ready, running, fault condition)	X	X
Alarm	X	X
Automatic reset and remote reset via the bus	X	X
Indication of the motor load	X	X
Differentiation of faults		X
Remote parameter setting and viewing of all functions		X
"Statistics" function		X
"Monitoring" function		X

Presentation of the Power Unit

Description

The power unit consists of:

- Three current transformers (see *Transformer Characteristics, page 19*):
 - Supplied by **Schneider Electric** ==> LUTC••01
 - Other suppliers ==> characteristics to be adhered to
- A contactor
- A short-circuit protection device

NOTE: In combination with LUTC••01 current transformers, the LUTM••BL controller base must only be used with motors from 0.75 kW to 450 kW/800 A nominal.

Current Transformer and Contactor

Product reference (**Schneider Electric**) for the current transformers and contactor.

Current transformers	3 * LUTC••01	
Contactor	Non-reversing LC1••••	Reversing LC2••••

Protection Against Short-Circuits

Protection against short-circuits is provided by one of the following:

- Magnetic circuit-breaker
- Fuses

⚠ WARNING

VALIDITY OF THERMAL PROTECTION

Thermal-magnetic motor circuit-breakers are prohibited since they incorporate an overload protection function, which would duplicate that in the modules and interfere with the control-unit analysis.

Failure to follow these instructions can result in death, serious injury, or equipment damage.

Protection Via a Magnetic Circuit-Breaker

Magnetic circuit-breaker

Power (1)		Circuit-Breaker		
P (kW)	I _e (A)	Reference	Rating (A)	FLAm (A) (2)
0.75 to 400	2 to 710	NS•••H	2.5 to 800	25 to 8000
0.75 to 15	2 to 32	GV2-L2•	2 to 32	33 to 420

(1) Standard power ratings for 50/60 Hz 400/415 V 3-phase motors

(2) FLAm = Magnetic circuit-breaker setting current

Protection with Fuses

Fuses with disconnect switch.

Power (1)		aM fuse		Disconnect Switch
P (kW)	I _e (A)	Size	Rating (A)	Reference
0.75 to 315	2 to 555	10.3x38 to T3	4 to 630	GS1-DD to GS1-S

Fuses with holder.

Power (1)		aM fuse		Holder
P (kW)	I _e (A)	Size	Rating (A)	Reference
0.75 to 15	2 to 32	10.3x38	4 to 32	LS1•
0.75 to 55	2 to 105	14x51 to 22x58	4 to 125	GK1•

(1) Standard power ratings for 50/60 Hz 400/415 V 3-phase motors

Assembly of the LUTM controller

Principle

The function module or communication module (optional) is installed in the controller base beneath the control unit, which locks it in position.

Installation

You must proceed as follows when assembling the controller:

Step	Action
1	Install the module (optional): <ul style="list-style-type: none"> ● Function module: <ul style="list-style-type: none"> - LUFW10 thermal-overload alarm - LUFV2 motor-load indication ● LULC• communication module
2	Install the control unit: <ul style="list-style-type: none"> ● Advanced LUCBT1BL/LUCDT1BL ● Multifunction LUCMT1BL

Location of the components.

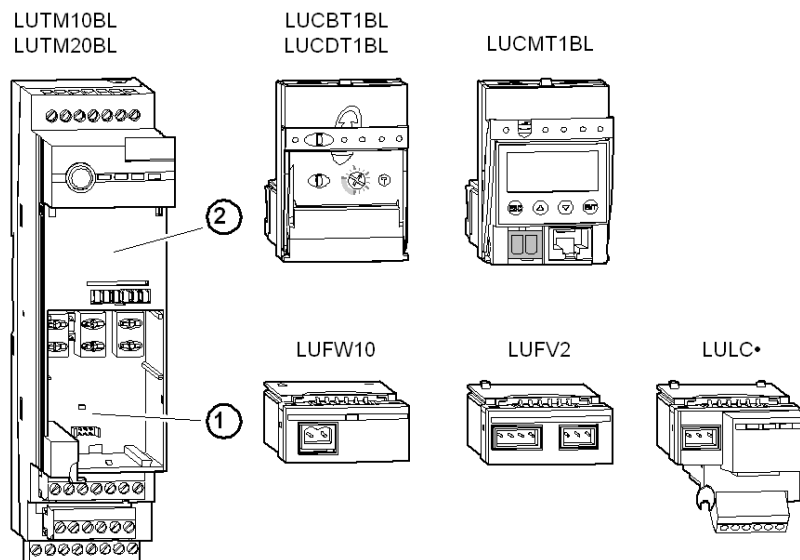

Connection

Connecting the Transformers

⚠ WARNING

LOSS OF THERMAL PROTECTION

Switch off the power supply before disconnecting the current transformers.

Do not disconnect the current transformers during operation.

Failure to follow these instructions can result in death, serious injury, or equipment damage.

Disconnecting the current transformers during use will disable controller protection.

The three current transformers are connected to the fixed terminals.

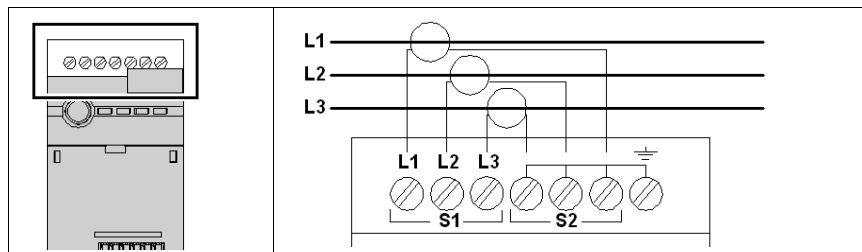

These terminals can be used to measure the current in all three phases:

- 2 x 3 terminals for connecting the current-transformer secondaries placed in each of the 3 power phases: L1 - L2 - L3
- One ground terminal for connecting the center point

NOTE: Use of the ground terminal is not compulsory.

Transformers to be Used

In order to operate correctly, the LUTM controller requires an accurate current value received from the current-transformer secondary.

It is **essential to use "motor protection"** transformers, which accept up to 10 times the nominal current with accuracy of at least 5% (5P10).

NOTE: Typical "measurement" type transformers are prohibited as their operating range is too limited and therefore they are not sufficiently accurate.

Transformer Characteristics

If the transformer supplier is **Telemecanique**: the references to be ordered are as follows.

Motor In	Primary (A)	Secondary (A)	No. of Pass(es)	Reference
3.5 to 10.5	30	1	3	LUTC0301
5.2 to 16	30	1	2	LUTC0301
10.5 to 32	30	1	1	LUTC0301
17.5 to 3	50	1	1	LUTC0501
35 to 105	100	1	1	LUTC1001
70 to 210	200	1	1	LUTC2001
140 to 420	400	1	1	LUTC4001
280 to 840	800	1	1	LUTC8001

Illustration showing how current transformers are set up.

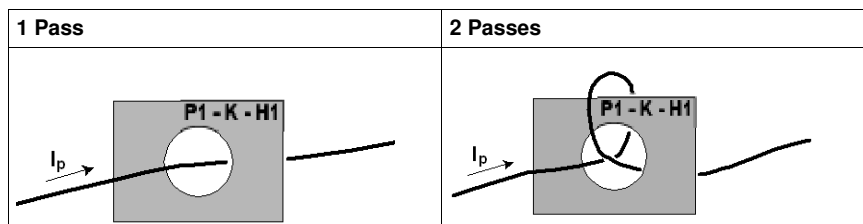

All three CTs must be connected in the same way in order to ensure **identical relative polarity**: the cable must be routed in the same direction for the three current transformers (entering via the side marked P1-K-H1).

Connecting the Power Supply and the Control Inputs

In order to operate, the LUTM controller must be powered by a 24 V $\overline{\text{---}}$ source.

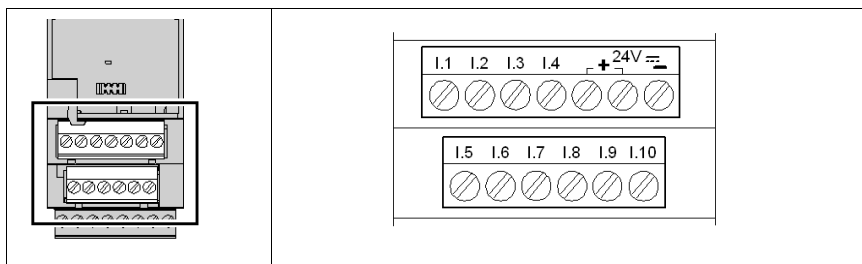

Both these terminal blocks are removable.

- 2 terminals for 24 V $\overline{\text{---}}$ power supply
- 1 terminal for the power-supply connection to the inputs
- 10 terminals for the control inputs

NOTE: The LUTM controller is rated IP20 or higher. However, for best protection from electric shock and consistent product performance, do not touch the connections during product operation.

The 24 V $\overline{\text{---}}$ is distributed internally in order to supply power directly (without additional customer wiring) to:

- The advanced (LUCBT or LUCDT) or multifunction (LUCMT) control unit
- The LULC• communication module

NOTE: Power is supplied to the control unit, the function module and the communication module automatically once they are installed in the controller base.

Particular Feature of the LULC• Communication Module

In "remote via the bus" or "mixed" mode.

Example of connection of the 24 V --- power supply to an LULC033 module:

The use of outputs OA1, OA3 and LO1 on an LULC• communication module requires a 24 V --- power supply connected to the controller.
Inputs LI1 and LI2 do not require an external power supply.
 Use a cable shorter than 5 cm to connect the LUTM controller's 24 V(-) to the LULC• communication module's 24 V(-).
 Do not connect the LULC• communication module's AUX 24 V (+) when the module is mounted on the LUTM controller.

Connecting the Outputs

Relay outputs - 24 V --- or 24 V to 250 V \sim .

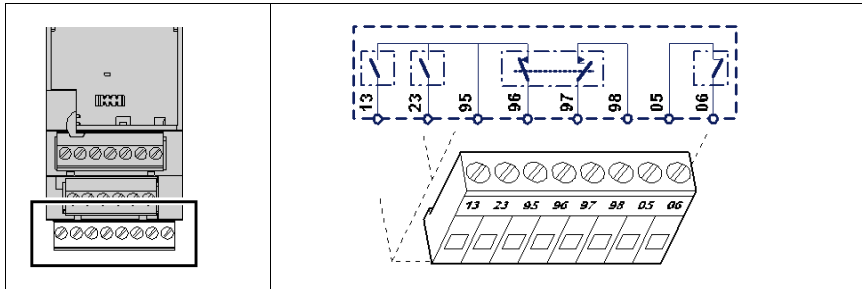

NOTE: The contacts (95 - 96) and (97 - 98) are shown with the controller powered up, input I.6 at 1 and in the absence of any fault condition.

This terminal is removable.

- 2 NO contacts (13 and 23) for controlling the contactors
- 1 NO contact (95 - 96) and NC contact (97 - 98): "Any fault" relay
- 1 NC contact (05 - 06): "Control-unit fault" relay.

State of the Output Relays

Before power-up.

	Output	Relay	Status
	05 - 06	"Control unit fault"	Closed
	95 - 96	"Any fault"	Open
	97 - 98		Closed

After power-up (24 V ---) with input I.6 at 1 and in the absence of any fault condition.

	Output	Relay	Status
	05 - 06	"Control unit fault"	Closed
	95 - 96	"Any fault"	Closed
	97 - 98		Open

NOTE: See also *Fault Management and Reset Mode*, page 32.

Connection Capacities

Table showing conductor cross-sections to be used.

Connection	Type of Conductor	Cross-Section (min. - max.)	
		mm ²	AWG
1 conductor	Solid conductor	0.2 ... 2.5 mm ²	AWG 24 ... AWG 12
	Stranded conductor	0.2 ... 2.5 mm ²	AWG 24 ... AWG 12
	Stranded conductor with cable end: - Non-insulated - Insulated	0.25 ... 2.5 mm ² 0.25 ... 2.5 mm ²	AWG 24 ... AWG 12 AWG 24 ... AWG 12
2 conductors (same cross-section)	2 solid conductors	0.2 ... 1 mm ²	AWG 24 ... AWG 18
	2 stranded conductors	0.2 ... 1.5 mm ²	AWG 24 ... AWG 16
	2 stranded conductors with cable end, non-insulated	0.25 ... 1 mm ²	AWG 24 ... AWG 18
	2 stranded conductors with TWIN cable end, insulated	0.5 ... 1.5 mm ²	AWG 20 ... AWG 16

Connectors	6, 7 and 8 pts	
Pitch	5 mm	0.2 in.
Tightening torque	0.5/0.6 N.m.	4.43/5.31 lb.in.
Flat screwdriver	3.5 mm	0.14 in.

Starting Up the LUTM Controller

Principle

Certain settings must be made before starting up the controller.

Current Transformers

Before attempting to start up the controller, the characteristics of the current transformers used must be specified for each control unit.

 WARNING
<p>INADEQUATE THERMAL PROTECTION</p> <p>The transformer ratio must be set in order to:</p> <ul style="list-style-type: none"> ● Indicate the characteristics of the current transformers used ● Determine the default value of the adjustment range for the current threshold required for setting the thermal protection ● Connect the current transformers to the LUTM prior to starting the LUTM controller <p>Failure to follow these instructions can result in death, serious injury, or equipment damage.</p>

Setting the Advanced Control Unit

The characteristic of the current transformers used must be indicated before any attempt to power up the controller, by setting the thermal protection on the front panel of the advanced control unit: range from 35% to 105%.

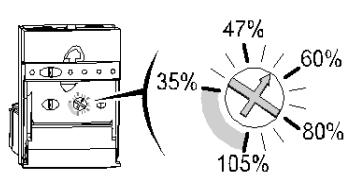
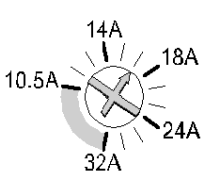
	<p>A set of 8 self-adhesive labels is supplied with each TeSys U controller, enabling the user to set the current value directly in Amps. Example></p>	
------------------------------------------------------------------------------------	-----------------------------------------------------------------------------------------------------------------------------------------------------------------	--------------------------------------------------------------------------------------

Method of calculating the percentage to be applied:

$$\text{Equivalent CT transformer ratio} = \frac{I_{\text{primary of CT (current transformer)}}}{I_{\text{secondary of CT} \times \text{no. of pass(es) in the primary}}$$

$$\% \text{ setting} = \frac{\text{Motor In}}{\text{Equivalent CT transformer ratio}} \times 100$$

Example 1 (I secondary = 1A in all cases):

3 kW motor at 400 V motor In of 6.5 A	Motor In	Primary (A)	No. of passes
Current transformer (CT) selected from one of the 2 options (see <i>Transformer Characteristics, page 19</i>): CT = 30:1 Number of passes = 2	3.5 to 10.5	30	3
	5.2 to 16	30	2
Calculation to be performed to determine the percentage to be applied in order to set the thermal protection			
<ul style="list-style-type: none"> ● Equivalent CT transformer ratio = 30/(1 x 2) = 15 ● % setting = (6.5 x 100)/15 = 43% 			

Example 2:

90 kW motor at 400 V motor In of 165 A	Motor In	Primary (A)	No. of passes
Current transformer (CT) selected from one of the 2 options (see <i>Transformer Characteristics, page 19</i>): CT = 200:1 Number of passes = 1	70 to 210	200	1
	140 to 420	400	1
Calculation to be performed to determine the percentage to be applied in order to set the thermal protection			
<ul style="list-style-type: none"> ● Equivalent CT transformer ratio = 200/(1 x 1) = 200 ● % setting = (165 x 100)/200 = 83% 			

No. of passes = Number of pass(es) in the current-transformer primary.

Setting the LUCMT Multifunction Control Unit

The characteristic of the current transformers used is selected when the controller is first powered up in the "CT_Ratio" function of the "Configure" menu.

The protection, alarm and diagnostic functions can be configured and monitored:

- Locally via the built-in keypad and display unit
- Remotely via the Modbus RS 485 RJ-45 communication port, using:
 - A PC equipped with PowerSuite software (VW3A8104)
 - A PDA equipped with PowerSuite software (VW3A8104)
 - An XBT NU 400 operator dialog terminal mounted on a cabinet door

Refer to the documentation for this product.

Operation of the LUTM controller

2

This chapter describes the operating modes in each of the two configurations (with or without the communication module) and the inputs used.

Operation also covers the management of faults and the various reset modes.

What's in this Chapter?

This chapter contains the following topics:

Topic	Page
Operating Modes	26
Fault Management and Reset Mode	32

Operating Modes

Presentation

Operating modes and inputs used for each configuration.

Configuration	Operation		Inputs used
Without communication module	"Local" mode		I.1, I.2, I.6 + I.5
With communication module	"Local" mode (default)	"Mixed" mode (if I.10 = 1)	I.1, I.2, I.3, I.4, I.6 + I.10 + I.5 I.7, I.8 and I.9
	"Remote via the bus" mode.	"Mixed" mode (if I.10 = 0)	I.1, I.2, I.3, I.4, I.6 + I.10 + I.5 I.7, I.8 and I.9

NOTE: The operating mode ("local", "remote via the bus" or "mixed") must be configured in the communication module. (*Refer to the documentation for this product*)

In the PLC, the user can read the word reflecting the state of the I/O at any time.

Inputs Used WITHOUT a Communication Module

4 inputs are used in a configuration **without** a communication module.

Input	Function	Output	Comment
I.1	Each input controls the output relay.	13	= state of the input
I.2		23	= state of the input
Note: If the voltage is too low, the output opens. An external fault or control unit fault has no effect on the state of these relays.			
I.5 RST (Reset)	This input is dedicated. It is used for remote "manual" reset of the controller following a control unit fault.	- - -	Using a reset button on the front of the rack or control panel
I.6 SF (System Fault)	This input is dedicated. It is used to feed back trip data from an additional protection device to the controller. This input must be connected to 24 V(+) to enable LUTM controller operation in the absence of a data signal from an additional protection device.	- - -	<i>Example:</i> Receipt of the data provided by the "Trip" NC contact: => For a circuit-breaker, a sensor relay, a voltage relay => For a string of these contacts

NOTE: Inputs I.3, I.4 and I.7 to I.10 are only used in a configuration **with** a communication module.

Examples of Applications

Machines with manual local control.

2-wire control by the controller I/O (non-reversing)

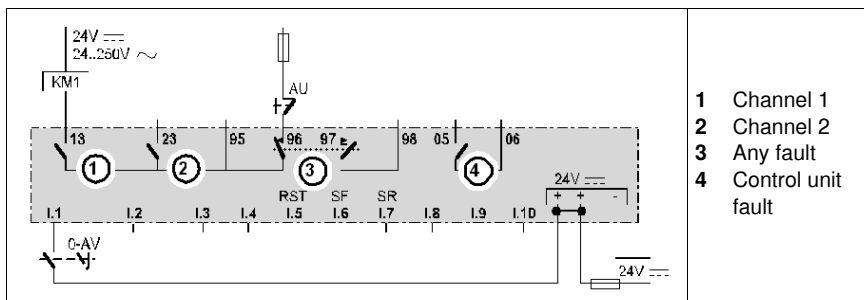

2-wire control by the controller I/O (reversing)

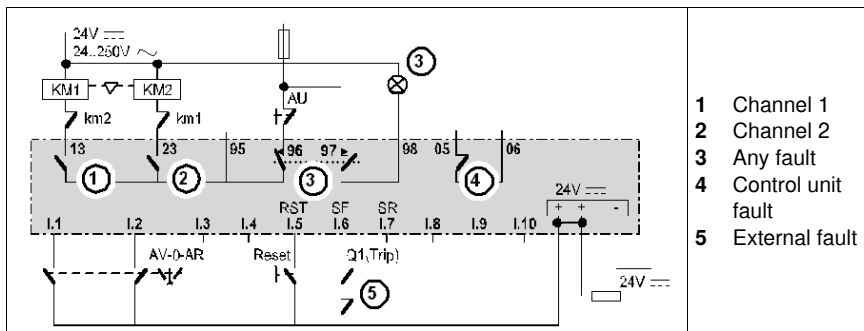

3-wire control by the controller I/O (reversing)

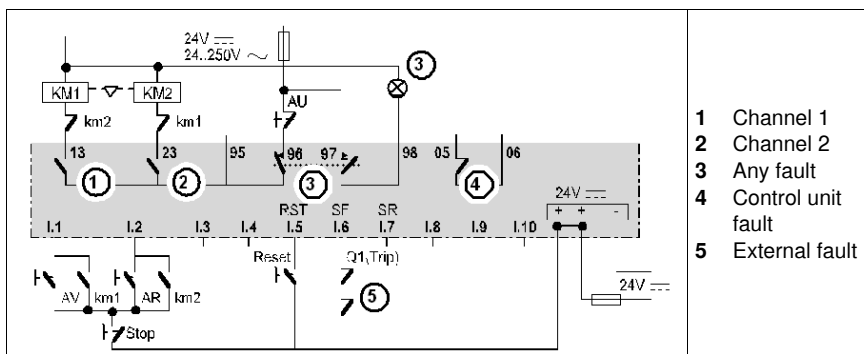

Inputs Used WITH a Communication Module

7 inputs are used in a configuration **with** a communication module.

Input	Function	Output	Comment
I.1	In " local " mode: Each input controls the output relay.	13	= state of the input
I.2		23	= state of the input
I.1	In " remote via the bus " mode: These inputs are available for sending back external data via the communication bus (writing to a register).	13	= state of the register
I.2		23	= state of the register
Note: If the voltage is too low, the output opens. An external fault or control unit fault has no effect on the state of these relays.			
I.3 or I.4	These inputs are dedicated to feeding back the state of the contactor controlled by the output relay.	- - -	
I.5 RST (Reset)	This input is dedicated. It is used for remote " manual " reset of the controller following a control unit fault.	- - -	Using a reset button on the front of the rack or control panel
I.6 SF (System Fault)	This input is dedicated. It is used to feed back trip data from an additional protection device to the controller.	- - -	<i>Example:</i> Receipt of the data provided by the "Trip" NC contact: => For a circuit-breaker, a sensor relay, a voltage relay => For a string of these contacts
I.10	In " local " or " remote via the bus " mode This input is used to send back external data via the communication bus (writing to a register).		
	In " local " mode.	Output	= state of the input
	In " remote via the bus " mode.	Output	= state of the register
	In " mixed " mode. This input feeds back the " local " or " remote via the bus " data and enables the controller to manage the command priorities.		
	If I.10 = 1 then: " local " mode.	Output	= state of the input
	If I.10 = 0 then: " remote via the bus " mode.	Output	= state of the register

Additional Inputs

3 inputs can be used in addition to those already mentioned during operation **with** a communication module.

Input	Function	Comment
I.7 SR (System Ready)	This input is dedicated. It is used to communicate the system availability via the bus. However if the mapping "Ready" bit is not used, I.7 is available for feeding back any other data item.	<i>Example:</i> receipt of the data provided by the circuit-breaker "Ready" NO contact.
I.8	This input is used to send back external data via the communication bus (writing to a register). It has no effect on controller operation.	<i>Example:</i> "emergency stop button status".
I.9		<i>Example:</i> in the case of a control panel with "rack in test position".

Control of Outputs 13 and 23

Control of outputs 13 and 23 of the LUTM controller depends on the selected operating mode. (*Refer to the documentation for the communication module*)

Operation	Comment
"Local" mode	Outputs 13 and 23 are only controlled by inputs I.1 and I.2. <i>Commands via the bus are not taken into account.</i>
"Remote via the bus" mode.	Outputs 13 and 23 are only controlled by the bus. <i>The state of inputs I.1 and I.2 does not affect outputs 13 and 23.</i>
"Mixed" mode (input I.10 manages the priorities)	"Local" mode if I.10 = 1 Outputs 13 and 23 are only controlled by inputs I.1 and I.2. <i>Commands via the bus are not taken into account.</i>
	"Remote via the bus" mode if I.10 = 0 Outputs 13 and 23 are only controlled by the bus, from the PLC. <i>The state of inputs I.1 and I.2 does not affect outputs 13 and 23.</i>

NOTE: Commands transmitted during communication are passed directly to the output relays, without wiring between the communication module outputs and inputs I.1 and I.2.

NOTE: Even when there is a control unit fault or external fault condition, outputs 13 and 23 can still be controlled. Their state is not necessarily "open", even if the communication module is faulty.

Examples of Applications

Control with "remote via the bus" operating mode.

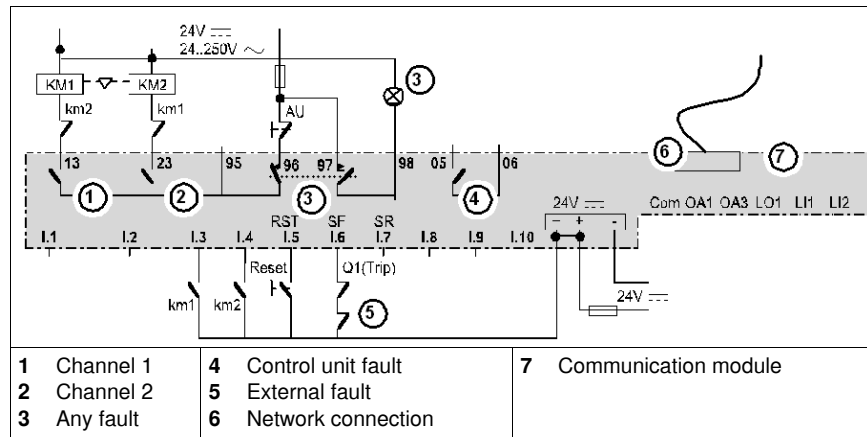

NOTE: To feed back external data via the communication bus (write to a register) using inputs I.1 and I.2, operation must be configured in "remote via the bus" mode. (Refer to the documentation for the communication module)

3-wire control with "local" or "remote via the bus" operating mode and data feedback (pushbutton voltage: 24 V DC).

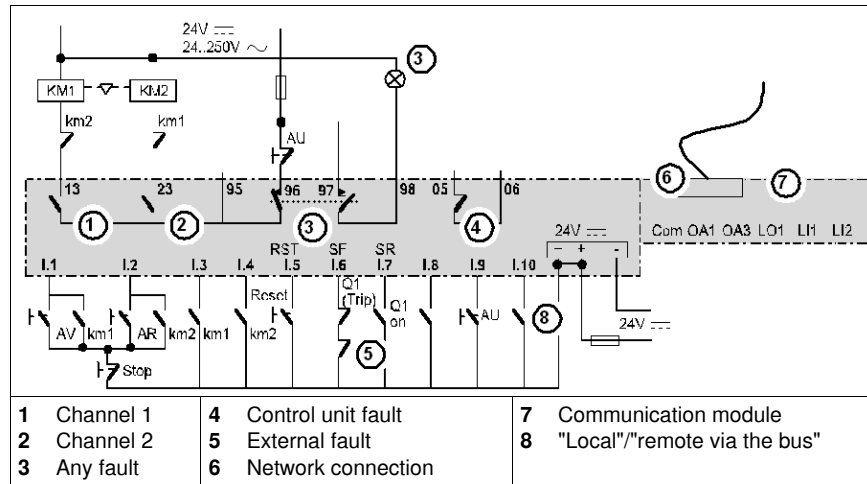

3-wire control with local operation, "remote via the bus" operating mode and data feedback (voltage local control > 24 V).

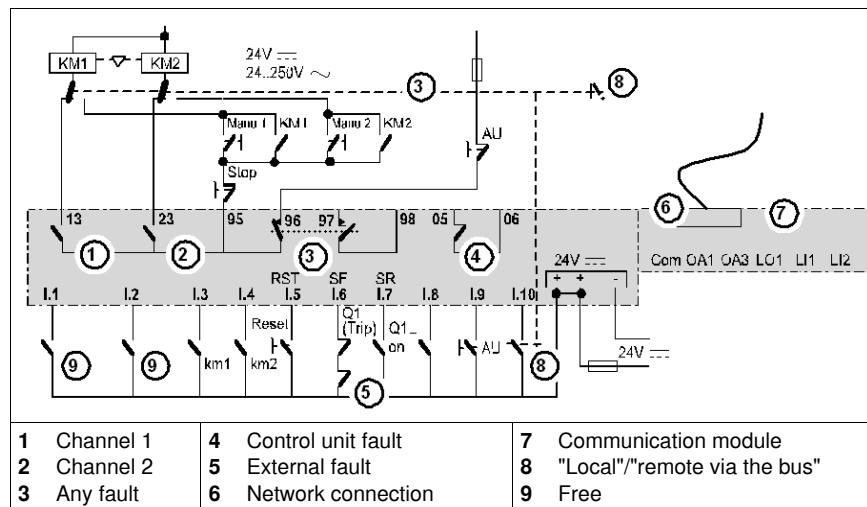

NOTE: To feed back external data via the communication bus (write to a register) using inputs I.1 and I.2, operation must be configured in "remote via the bus" mode. (Refer to the documentation for the communication module)

Three Examples of Fault Management

Safety of operation.

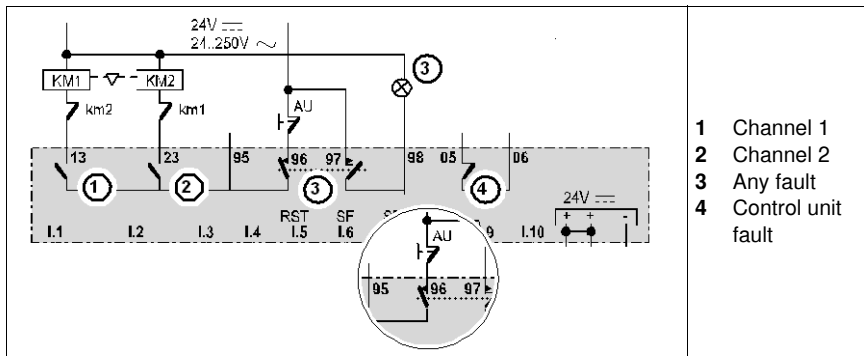

Motors stop in the event of:

- Tripping of the control unit
- Internal fault
- External fault

Motor stops only on tripping of the control unit.

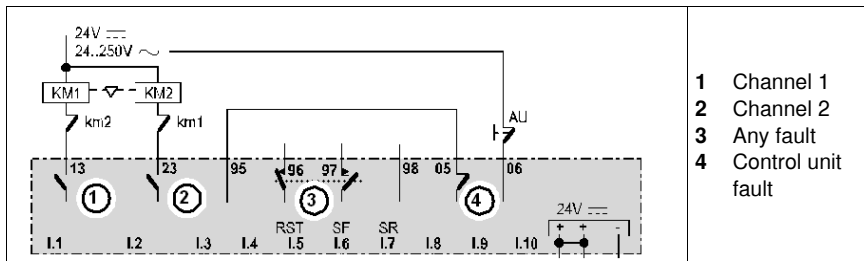

Continuity of service.

⚠ DANGER

LOSS OF OVERLOAD PROTECTION AND PROTECTION AGAINST OTHER FAULTS MONITORED.

If the controller base is connected in "continuity of service" mode, the motor will not stop in the event of a thermal overload or any other type of fault.

Failure to follow these instructions will result in death or serious injury.

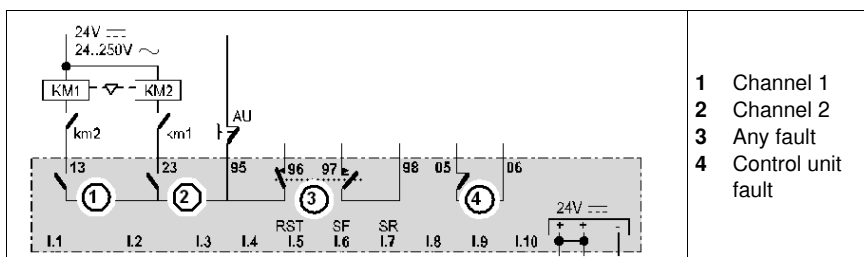

There is no longer a fault contact in series with the contactor coils.

The motors will not stop in the event of the control unit tripping or an external fault.

The controller simply tells the PLC why it is taking the necessary measures:

- Branch circuit
- Starting up the fans

If used with a multifunction control unit, continuity of service is detected on detection of a fault current; all the detected alarms are set to zero and are no longer managed.

Fault Management and Reset Mode

Presence of a Fault

The presence of a fault is indicated by:

- The state of the LEDs on the controller base
- The state of the LEDs on the communication module (see specific documentation)
- The alarm on the multifunction control unit (see specific documentation)
- The display of a message on the multifunction control unit screen
- The alarm on the advanced control unit used with a function module
- The state of the output relays on the controller base

Fault Reset

Following a control unit fault, the acknowledgment method is determined by which reset mode has been configured and by the type of fault. The operating mode ("local" or "remote via the bus") has no effect on the acknowledgment method used.

Configuration with advanced control unit:

Reset (acknowledgment)	Presence of a communication module	Can be reset using the following methods			
		LUTM pushbutton	Input I.5	Remote via the bus	Automatic
Manual	No	YES	YES	-	-
Manual	YES	YES	YES	No	No
Remote	YES	After delay	After delay	After delay	No
Automatic	YES	No	No	No	After delay

Configuration with multifunction control unit (with or without LULC• communication module).

Specifically for thermal overload faults:

Reset (acknowledgment)	Can be reset using the following methods			
	LUTM pushbutton	Input I.5	Remote via the bus	Automatic
Manual	YES	YES	No	No
Remote	After delay	After delay	After delay	No
Automatic	No	No	No	After delay

Other faults (e.g., jam, underload, ground fault):

Reset (acknowledgment)	Can be reset using the following methods			
	LUTM pushbutton	Input I.5	Remote via the bus	Automatic
Manual	YES	YES	No	No
Remote	YES	YES	YES	No
Automatic	YES	YES	YES	No

NOTE: The reset mode ("manual", "remote" or "automatic") must be configured beforehand in the multifunction control unit or communication module. (Refer to the documentation for the communication module)

State of the LEDs on the Controller Base

Measures to be taken according to the status of the "24 V $\overline{\text{---}}$ " and "FAULT" LEDs.

Status		Cause	Measure to be taken	The reset occurs
Green "24 V $\overline{\text{---}}$ " LED	Red "FAULT" LED	Controller status		
Off	Off	No 24 V $\overline{\text{---}}$ Voltage too low	Connect the controller to 24 V $\overline{\text{---}}$	On power-up (if no faults are present)
	On	Internal fault in the multifunction control unit	Power down and then power up the controller	
		Communication fault between the module and the controller		
		Internal controller fault		
Flashing (500 ms)	On	<ul style="list-style-type: none"> No control unit Control unit not locked 	Disconnect the controller from the power supply then install the control unit or check that the handle is locked. Then reconnect the controller.	On power-up (if the control unit is installed and locked correctly)
On	On	Control unit waiting for manual reset	Reset the control unit (see <i>Fault Reset, page 32</i>)	As soon as the power poles close after the reset
		Control unit waiting for reset via the bus	Reset the control unit (see <i>Fault Reset, page 32</i>)	After the reset command is accepted
	Flashing (500 ms)	All the controller output relays are in fault mode Control unit waiting for automatic reset	Wait for automatic reset	After the end of the delay
		External fault	Null	As soon as the external fault has disappeared

NOTE: A fault requiring a manual reset cannot be reset by powering down and then powering up the controller.

Measures to be taken according to the status of the LEDs on the output relay (13-23).

Status	Cause	Measure to be taken
Green LED (13) Off (relay "13" "open")	No run command	Issue a run command
Green LED (13) On (relay "13" "closed")	Contactors "closed"	Trouble-free operation
	Contactors "open" and red "FAULT" LED on	See <i>State of the LEDs on the Controller Base, page 33</i>
Green LED (23) Off (relay "23" "open")	No run command	Issue a run command
Green LED (23) On (relay "23" "closed")	Contactors "closed"	Trouble-free operation
	Contactors "open" and red "FAULT" LED on	See <i>State of the LEDs on the Controller Base, page 33</i>

Fault According to the State of the Output Relays on the Controller Base

After tripping, a control unit fault is declared if the state of the output relays is as follows:

Output	Relay	Status	Comment	Measure to be taken
05 - 06	"Control unit fault"	Open	Only on tripping of the control unit	Reset control unit fault (see <i>Fault Reset, page 32</i>)
95 - 96	"Any fault"	Open	All faults detected by the controller	
97 - 98		Closed		

Activation of I.5 (Reset) clears faults from the control unit.

After tripping, an **internal fault** is declared if the state of the output relays is as follows:

Output	Relay	Status	Comment	Measure to be taken
05 - 06	"Control unit fault"	Closed	Not affected	Switch off the controller 24 V $\overline{\text{---}}$ power supply by:
95 - 96	"Any fault"	Open	If a signal is present on I.6	<ul style="list-style-type: none"> ● Unplugging the 24 V $\overline{\text{---}}$ connector ● Disconnecting the control circuit
97 - 98		Closed		



After tripping, an **external fault** is declared if the state of the output relays is as follows:

Output	Relay	Status	Comment	Measure to be taken
05 - 06	"Control unit fault"	Closed	Not affected	Reset the product concerned after identification (it is not necessary to reset the controller)
95 - 96	"Any fault"	Open	If a signal is missing on I.6	
97 - 98		Closed		

NOTE: An external fault can come from a sensor relay, a protection module (e.g., voltage)

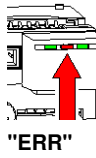

Acknowledgement of Application Faults

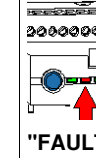
List of possible application faults.

Application faults	Registers		LULC•	LUCM•	LUTM	Fault acknowledgment
	451 Fault number	452 Fault bit	 "ERR"	 (line 2)	 "FAULT"	
Thermal overload fault	4	$\overline{\text{---}}_3 = 1$	Off	Overload	-	According to the reset mode configured in register 602
Application fault in the LUCM• multifunction control unit	3, and 5 to 12	Refer to the User's Manual for the LUCM••BL or LUCMT1BL multifunction control unit.				

Acknowledgement of Internal Faults

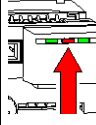

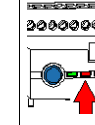
List of possible internal faults.

Internal faults	Registers		LULC•	LUCM•	LUTM	Fault acknowledgment
	451 Fault number	452 Fault bit	 "ERR"	 (line 2)	 "FAULT"	
Fault in the LULC• communication module	14	-	Off	M14	-	Power down and then power up the LULC• and the LUCM•
LULC• communication module not installed or not supplied with power	15	-		M15	-	
Internal fault in the LUC•• control unit	54	_.11 = 1		M54	-	
Fault in the LUCM• multifunction control unit	51 to 53, 55 to 63	Refer to the User's Manual for the LUCM••BL or LUCMT1BL multifunction control unit.				
Write-to-EEPROM fault	100	_.13 = 1	On	M100	-	Power down and then power up the LULC•
Communication fault with the LUCM• multifunction control unit	101	_. = 1	On	M101	Flashing	Power down and then power up the LULC•
Checksum fault in EEPROM	102	_.13 = 1	On	M102		Write: 704.3=1
EEPROM configuration fault	104	_.13 = 1	On	M104		Write: 704.3=1
Communication fault with the LUTM controller base	105	_.13 = 1	On	-		Power down and then power up the LULC•
Identification of the LUC•• control unit by the LULC• communication module	110	-	Off	-	Flashing	
LUTM internal fault	200	(not applicable)	-	-	See <i>State of the LEDs on the Controller Base, page 33</i>	Power down and then power up the LUTM
LUTM internal fault: Communication fault with the LULC• module	205	_.13 = 1	-	-		Power down and then power up the LUTM
LUTM internal fault: No control unit	206	_.13 = 1	-	-		Power down and then power up the LUTM

Alarm Acknowledgment

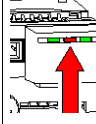
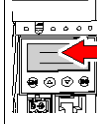
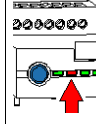
List of possible alarms.

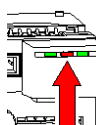
Alarms	Registers		LULC•	LUCM•	LUTM	Alarm acknowledgement
	460 Alarm number	461 Alarm bit	 "ERR"	 (line 1)	 "FAULT"	
Thermal overload alarm	3	_3 = 1	-	Overload alarm	-	Automatic when the overload is less than 85%
Loss of communication with the LULC• communication module alarm	109	(not applicable)	Flashing	Comm loss	Flashing	Write: 703.3=1
LUCM• multifunction control unit alarm	2, 4 to 13	Refer to the User's Manual for the LUCM••BL or LUCMT1BL multifunction control unit.				

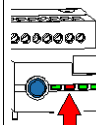
Alarms	Registers		LULC•	LUCM•	LUTM	Alarm acknowledgement
	460 Alarm number	461 Alarm bit	 "ERR"	 (line 1)	 "FAULT"	
LUTM external alarm indicated by I.6 changing to 0 (with LULC•)	201	_15 = 1	-	Warn-M201	Flashing	Automatic with I.6 returning to 1

Restart Following Loss of Communication

After acknowledgment by setting bit 703.3 to 1, restart according to the states of control bits 704.0 and 704.1.

Technical characteristics of the LUTM controller

3

Technical Characteristics

Environment

Table of the LUTM controller technical characteristics.

Certification			UL, CSA
Conformity to standards	IEC/EN 60947-4-1, UL 508, CSA C22-2 No. 14		
European community directives	CE marking. Satisfies the essential requirements of the low voltage (LV) machinery and electromagnetic compatibility (EMC) directives.		
Rated insulation voltage (Ui)	According to IEC/EN 60947-1, overvoltage category III, degree of pollution: 3	V	240
	According to UL 508, CSA C22-2 no. 14	V	240
Rated impulse withstand voltage (Uimp)	According to IEC/EN 60947-4-1	kV	4
Degree of protection according to IEC/EN 60947-1 (protection against direct finger contact)	Front panel (outside connection zone)		IP 40
	Front panel and wired terminals		IP 20
	Other sides		IP 20
Protective treatment	According to IEC/EN 60068		"TH"
	According to IEC/EN 60068-2-30	Cycles	12
	According to IEC/EN 60068-2-11	hrs	48
Ambient air temperature around the device	Storage	°C °F	- 40 + 85 - 40 + 185
	Operation	°C °F °C °F	- 25 + 70 (LUCBT/DT/LUTM) - 13 + 160 (LUCBT/DT/LUTM) - 25 + 60 (LUCMT, LULC•) - 13 + 140 (LUCMT, LULC•)
Maximum operating altitude		m ft	2000 6560
Fire resistance	According to UL 94		V2
	According to IEC/EN 60695-2-1	°C °F	960 1760 (parts supporting live components)
		°C °F	650 1200
Half-sine mechanical shock pulse = 11 ms	According to IEC/EN 60068-2-27 (1)		15 gn
Resistance to vibration 5...300 Hz	According to IEC/EN 60068-2-6 (1)		4 gn
Immunity to electrostatic discharge	According to IEC/EN 61000-4-2	kV	In the air: 8 - Level 3
		kV	On contact: 8 - Level 4
Immunity to radiated fields	According to IEC/EN 61000-4-3	V/m	10 - Level 3

Immunity to fast transient bursts	According to IEC/EN 61000-4-4	kV	Current-transformer inputs and outputs: 4 - Level 4
	According to IEC/EN 61000-4-4	kV	Inputs and power supply: 2 - Level 3
Immunity to radio-electric fields	According to IEC/EN 61000-4-6	V	10

(1) Without modifying the state of the contacts in the least favorable direction.

Controller base and control unit relays.

Surge immunity	According to IEC/EN 61000-4-5 Control voltage 24 V c		Common mode	Differential mode
	Output relay	kV	4	2
	Inputs	kV	2	1
	Serial communication	kV	2	-

Characteristics of the Control Power Supply

Table of the LUTM controller technical characteristics.

Supply voltage		V	24
Power consumed	According to IEC/EN 60947-1	W	2
Power-supply voltage range	According to IEC/EN 60947-1	V	20 to 29
Overcurrent protection	24 V fuse		0.5A gG
Resistance to microbreaks		ms	Compatible with Phaseo power supply
Resistance to voltage dips	According to IEC/EN 61000-4-11		70% of UC min. for 500 ms

Input Characteristics

Table of the LUTM controller technical characteristics.

Nominal input values	Voltage	V	24 V (positive logic)	
	Current	mA	7	
Input limit values	At state 1	Voltage	V	16
		Current	mA	6
	At state 0	Voltage	V	5
		Current	mA	2
Response time	Change to state 1	ms	10 +/- 30%	
	Change to state 0	ms	10 +/- 30%	
IEC 1131-2 conformity		A	Type 1	
Type of input			Resistive	

Characteristics of Discrete Outputs

Table of the LUTM controller technical characteristics.

Type		Single-break contacts	
Load	Alternating current		C 300 (LUTM10BL) B 300 (LUTM20BL)
	Direct current		24 V/5 A
Maximum power in AC-15 (for 500,000 operating cycles)	VA		180 (LUTM10BL) 500 (LUTM20BL)
			30 (LUTM10BL) 30 (LUTM20BL)
Maximum power in DC-13 (for 500,000 operating cycles)	W		
Protection against output overcurrents			4 A gG

- 500,000 operating cycles on F500 contactors
- U_e AC max: 240 V
- U_e DC max: 30 V

Glossary

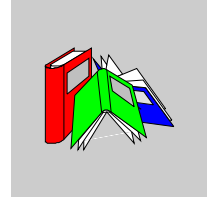

A

Any fault

"Any fault" relay:

This relay has 2 contacts: NO 95-96 and NC 97-98.

For optimum protection, contact 95-96 should be wired in series with the contactor coils.

Contact 97-98 is a signaling contact.

The relay is energized (95-96 closed and 97-98 open) if and only if:

- The controller is powered with 24 V DC
- The controller "external fault" input I.6 is at 1
- There is no control unit, base or module fault

C

Control unit fault

"Control unit fault" relay:

This relay has 1 NC contact (05-06).

The relay is energized (05-06 open) when the control unit trips on a thermal overload, phase loss, phase imbalance or ground fault.

NOTE: The multifunction control unit also trips in the event of: underload, overtorque, prolonged start.

E

External fault

The tripping of a protection device on the motor starter, other than the controller, is known as an "external fault".

For example, tripping of the circuit-breaker in the event of a short-circuit, tripping of a PTC sensor relay in the event of a winding or bearing overheating.

This data can be fed back to the controller by connecting the fault contacts on the devices in question to input I.6 on the controller. In this case, a product trip will cause contact 95-96 to open and contact 97-98 to close. The states of these contacts will change back automatically as soon as the tripped product has been reset.

I

Internal fault

Any malfunction of the controller/control unit/module assembly, other than application problems, is known as an "internal fault".

Examples: Internal fault in the base, the control unit or the communication module, or communication fault between the base and the module

L

Local

Operation in "local" mode:
The contactors are controlled by pushbuttons.

R

Remote via the bus

Operation in "remote via the bus" mode:
Contactors controlled via the communication bus, by changing the values of the command registers.

Index



A

Acknowledgement
 application fault, 34
 internal fault, 35
Advanced control unit
 Setting, 22
Alarm, 36
Application fault, 34
Assembly, 17

C

Characteristics, 37
Circuit-breaker, 16
Composition of a controller
 with communication, 13
 without communication, 12
Conditions of use, 11
Conductor, 21
Connection, 18
Controller bases, 13
CT_Ratio, 23

F

Fault, 34
Fault management, 32
Fault reset, 32
Fuses, 16

I

Inputs, 26, 28, 29
Internal fault, 35

L

LEDs, 14
Light-emitting diodes, 14
LULC•, 15

M

Multifunction control unit
 Setting, 23

P

Power, 16
Protection against short-circuits, 16

R

Restart, 36

S

Secondary, 11
Setting
 Advanced control unit, 22
 Multifunction control unit, 23
Startup, 22
State of relays, 20
State of the LEDs, 33

T

Terminal, 20
Terminal block, 19
Terminals, 18
Transformer, 16, 18, 22
Transformer ratio, 22

