

		3P/4P												
		A	B	C	D	E	F	G	H	I	J	K	L	M
(mm)		17,7	125	93	83	63	45	16	44	66	22,5	24	6	22

$2,5 \text{ mm}^2 \leq S \leq 55 \text{ mm}^2$

$2,5 \text{ mm}^2 \leq S \leq 35 \text{ mm}^2$

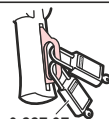
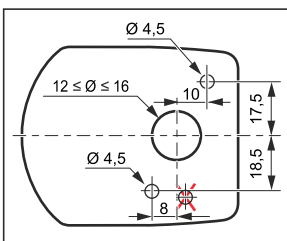
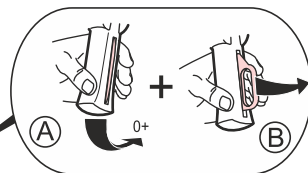
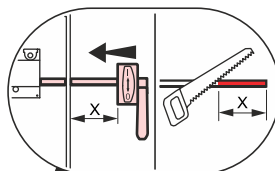
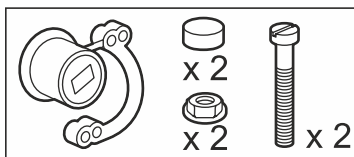
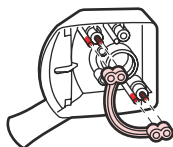
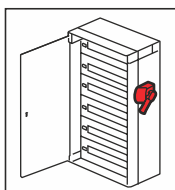
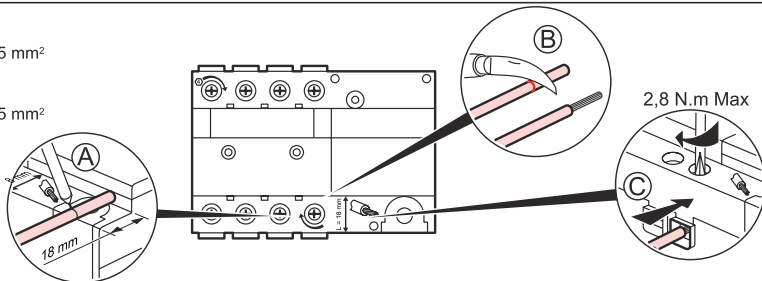

0 227 97

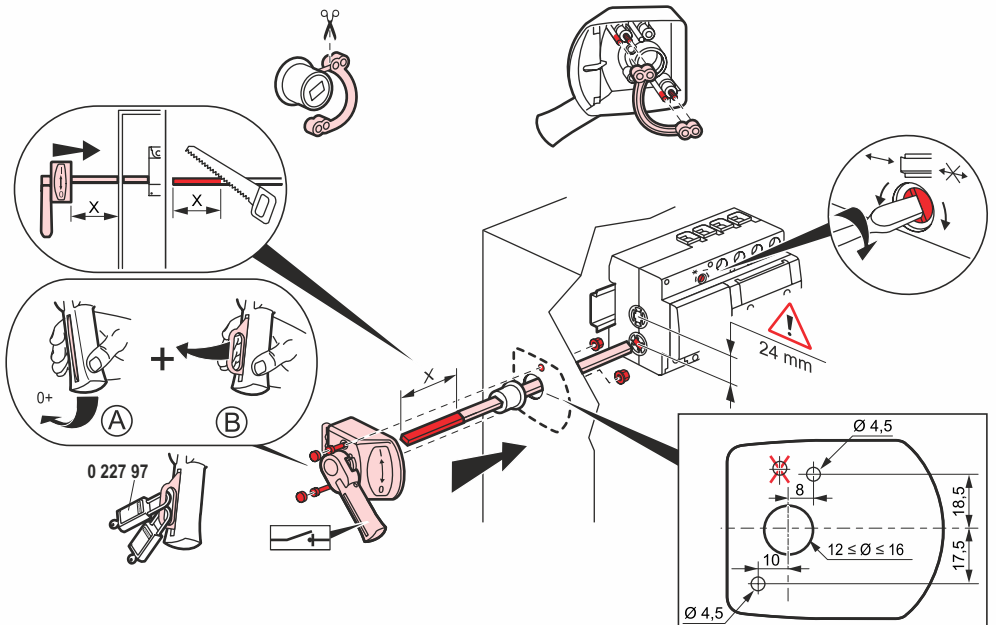
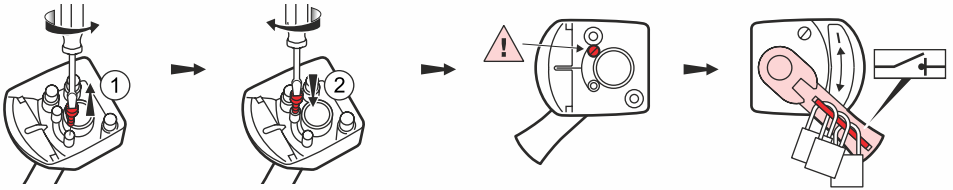
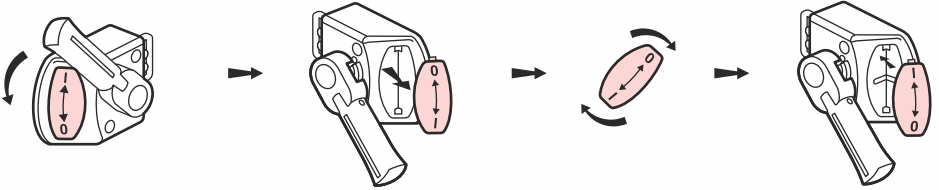
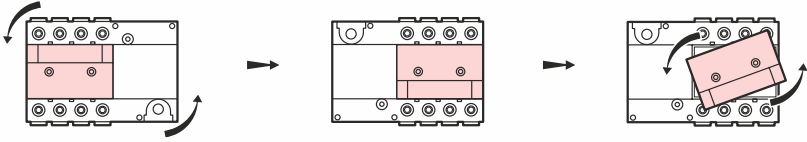
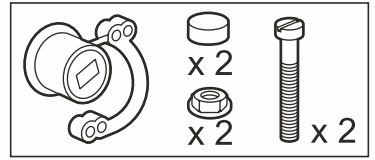
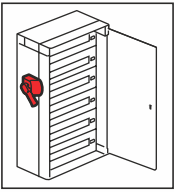

- Cas particulier :possibilité de verrouillage circuit fermé
- Bijzonder geval :mogelijkheid tot vergrendeling bij gesloten kring
- Special case :facility for closed circuit locking
- Sonderfall :Einrichtung zur Sperrung eines geschlossenen Stromkreises
- Caso particular :Posibilidad de bloqueo circuito cerrado
- Caso particular :possibilidade de encravamento em circuito fechado
- Ειδική Περίπτωση : δυνατότητα κλειδώματος με το κύκλωμα κλειστό
- Szczególny przypadek : możliwość zablokowania dźwigni przy zamkniętym obwodzie

- Poignée à droite
- Handgriep rechts
- Handle to right
- Griff nach rechts
- Maneta a la derecha
- Manipulo à direita
- Λαβή δεξιά
- Dźwignia z prawej strony

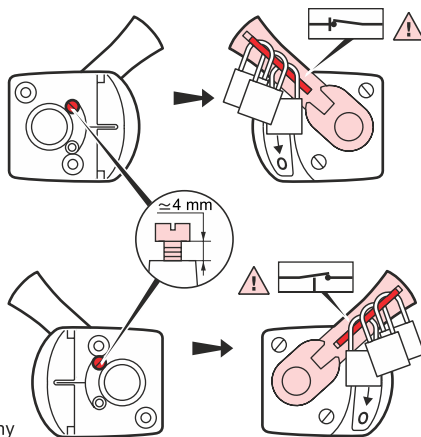

- Poignée à gauche
- Handgriep links
- Handle to left
- Griff nach links
- Maneta a la izquierda
- Manipulo à esquerda
- Λαβή αριστερά
- Dźwignia z lewej strony

- Montage des contacts auxiliaires
- Montage van de hulpcontacten
- Installing the auxiliary contacts
- Installation der Hilfskontakte
- Montaje de los contactos auxiliares
- Montagem de contactos auxiliares
- Συναρμολόγηση βοηθητικών επαφών
- Montaż styków pomocniczych

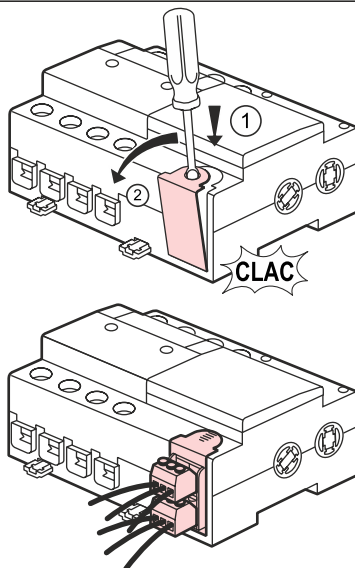
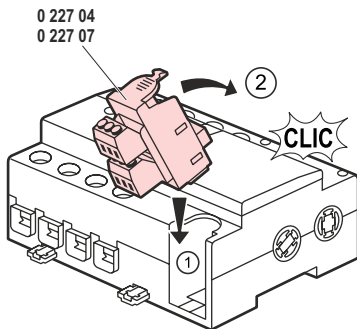

Ne pas respecter strictement les conditions d'installation et d'utilisation peut entraîner des risques de choc électrique ou d'incendie. (FR) (BE) (CA) (LU) (CH)

Door de installatie- en gebruiksvoorwaarden niet strikt na te leven, kan er gevaar voor elektrische schokken of brand ontstaan. (NL) (BE)

The instructions for installation and use must be strictly observed in order to avoid the risk of electric shock or fire. (GB) (CA) (IN) (IE) (US) (AU) (NZ)

Bei Nichtbeachtung der Einbau- und Nutzungsvorschriften besteht Stromschlag- bzw. Brandgefahr. (DE)

El no cumplimiento estricto de las instrucciones de instalación y uso puede implicar riesgos de choque eléctrico o incendio. (ES) (CL) (CO) (CR) (MX) (PE) (US) (VE)

Não respeitar estritamente as condições de instalação e de utilização poderá proocar riscos de choque eléctrico ou de incêndio. (PT) (BR)

Niezastosowanie się ściśle do warunków instalacji i użytkowania może grozić porażeniem prądem lub pożarem. (PL)

Η μη αυστηρή τήρηση των συνθηκών εγκατάστασης και χρήσης μπορεί να επιφέρει κινδύνους ηλεκτροπληξίας ή πυρκαγιάς. (GR) (CY)

(ARB)

قد يتسبب عدم احترام شروط التركيب والاستعمال احتراماً تاماً في التعرض إلى صدمة كهربائية أو نشوب حريق.

XL³ 160/400 □

