



Product designation				Power contactor
Product type designation				BGP09
Contact characteristics				
Number of poles	Nr.			3
Rated insulation voltage U_i IEC/EN	V			500
Rated impulse withstand voltage U_{imp}	kV			6
Operational frequency	min	Hz	25	
	max	Hz	400	
IEC Conventional free air thermal current I_{th}	A			20
Operational current I_e	AC-1 ($\leq 40^\circ\text{C}$)	A	20	
	AC-1 ($\leq 55^\circ\text{C}$)	A	18	
	AC-1 ($\leq 70^\circ\text{C}$)	A	15	
	AC-3 ($\leq 440\text{V} \leq 55^\circ\text{C}$)	A	9	
	AC-4 (400V)	A	4	
Rated operational power AC-3 ($T \leq 55^\circ\text{C}$)	230V	kW	2.2	
	400V	kW	4	
	415V	kW	4.3	
	440V	kW	4.5	
	500V	kW	5	
Rated operational power AC-1 ($T \leq 40^\circ\text{C}$)	230V	kW	8	
	400V	kW	14	
	500V	kW	16	
Short-time allowable current for 10s (IEC/EN60947-1)	A			96
Protection fuse	gG (IEC)	A	20	
	aM (IEC)	A	10	
Making capacity (RMS value)	A			92
Breaking capacity at voltage	440V	A	72	
	500V	A	72	
Resistance per pole (average value)	m Ω			10
Power dissipation per pole (average value)	I_{th}	W	4	
	AC-3	W	0.81	
Tightening torque for terminals	min	Nm	0.8	
	max	Nm	1	
	min	lbin	9	
	max	lbin	9	
Tightening torque for coil terminal	min	Nm	0.8	

		max	Nm	1
		min	lbin	9
		max	lbin	9
Max number of wires simultaneously connectable			Nr.	2
Conductor section	AWG/Kcmil	max		12
	Flexible w/o lug conductor section	min	mm ²	0.8
		max	mm ²	2.5
	Flexible c/w lug conductor section	min	mm ²	1.5
		max	mm ²	2.5
	Flexible with insulated spade lug conductor section	min	mm ²	1.5
		max	mm ²	2.5
Power terminal protection according to IEC/EN 60529				IP00
Mechanical features				
Operating position		normal allowable		Vertical plan ±30°
Fixing				Screw / DIN rail 35mm
Weight			g	240
Conductor section	AWG/kcmil conductor section	max		12
Auxiliary contact characteristics				
Thermal current I _{th}		A		10
IEC/EN 60947-5-1 designation				A600 - Q600
Operating current AC15		230V	A	3
		400V	A	1.9
		500V	A	1.4
Operating current DC12		110V	A	2.9
Operating current DC13		24V	A	2.9
		48V	A	1.4
		60V	A	1.1
		125V	A	0.3
		220V	A	0.1
		600V	A	0.6
Operations				
Mechanical life		cycles		20000000
Electrical life		cycles		500000
Safety related data				
Performance level B10d according to EN/ISO 13489-1		rated load	cycles	500000
		mechanical load	cycles	20000000
Mirror contacts according to IEC/EN 60947-4-1				yes
EMC compatibility				yes
DC coil operating				

DC rated control voltage		V	60
DC operating voltage			
	pick-up	min	%Us 75
		max	%Us 115
	drop-out	min	%Us 10
		max	%Us 25
Average coil consumption ≤20°C			
	in-rush	W	3.2
	holding	W	3.2

Max cycles frequency

Mechanical operation		cycles/h	3600
----------------------	--	----------	------

Operating times

Average time for Us control			
	in AC		
	Closing NO	min	ms 12
		max	ms 21
	Opening NO	min	ms 9
		max	ms 18
	Closing NC	min	ms 17
		max	ms 26
	Opening NC	min	ms 7
		max	ms 17
	in DC		
	Closing NO	min	ms 18
		max	ms 25
	Opening NO	min	ms 2
		max	ms 3
	Closing NC	min	ms 3
		max	ms 5
	Opening NC	min	ms 11
		max	ms 17

UL technical data

Full-load current (FLA) for three-phase AC motor			
	at 480V	A	7.6
	at 600V	A	6.1

Yielded mechanical performance			
	for single-phase AC motor		
	110/120V	HP	0.5
	230V	HP	1.5
	for three-phase AC motor		
	200/208V	HP	2
	220/230V	HP	3
	460/480V	HP	5
	575/600V	HP	5

General USE

Contactor

AC current A 20

Contact rating of auxiliary contacts according to UL

A600 - Q600

Ambient conditions

Temperature

Operating temperature

min °C -50
max °C +70

Storage temperature

min °C -60
max °C +80

Max altitude

m 3000

Resistance & Protection

Pollution degree

3

Dimensions

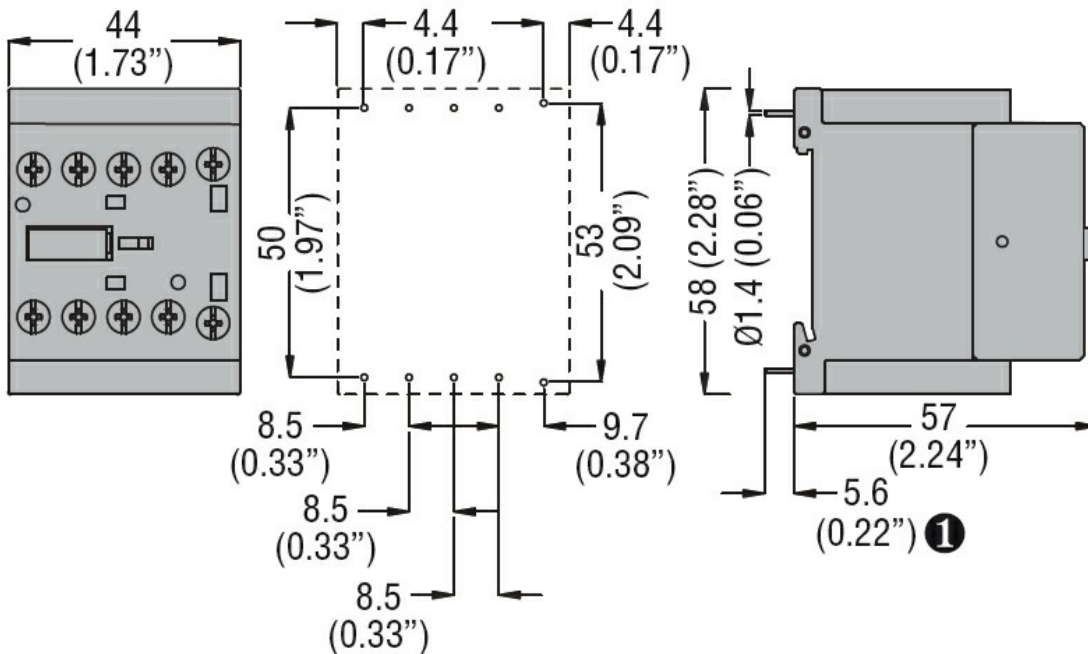

① Recommended PCB drillings 1.7-2mm.

Wiring diagrams

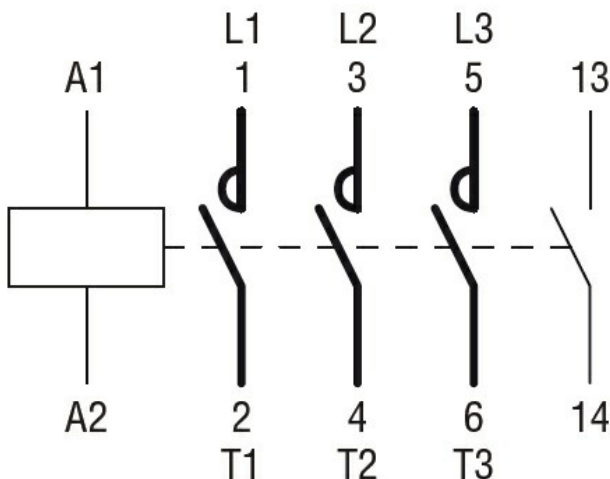

Certifications and compliance

Compliance

CSA C22.2 n° 60947-1

CSA C22.2 n° 60947-4-1

IEC/EN 60947-1

IEC/EN 60947-4-1

UL 60947-1

UL 60947-4-1

Certificates

cURus

EAC

ETIM classification

ETIM 8.0

EC000066 -
Power contactor,
AC switching