

Inductive proximity sensors / Détecteurs de proximité inductifs
 Induktive Näherungsschalter / Detectores de proximidad inductivos
 Interruttori di prossimità induttivi / Detectores de proximidade indutivos

XSD-.....8

XSD-.....9

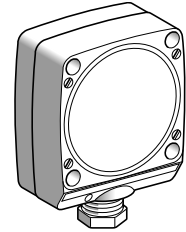
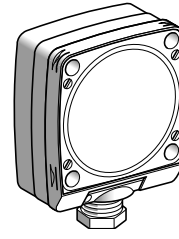

⚠ DANGER / PELIGRO / DANGER

HAZARDOUS VOLTAGE Disconnect all power before servicing equipment. Electric shock will result in death or serious injury.	TENSION PELIGROSA Desenergice el equipo antes de realizarle servicio. Una descarga eléctrica podrá causar la muerte o lesiones serias.	TENSION DANGEREUSE Couper l'alimentation avant de travailler sur cet appareil. Une électrocution entrainera la mort ou des blessures graves.
---	--	--

Mechanical installation
 Mise en œuvre mécanique
 Mechanische Installation
 Instalación mecánica
 Messa in opera meccanica
 Instalação mecânica

mm / in

XSD-.....8

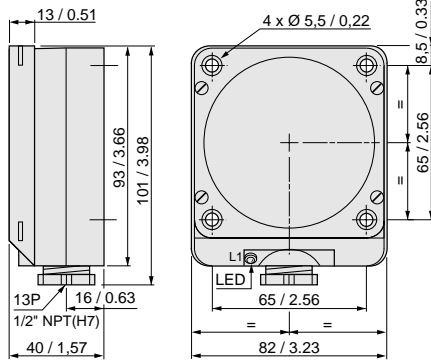

XSD-.....9

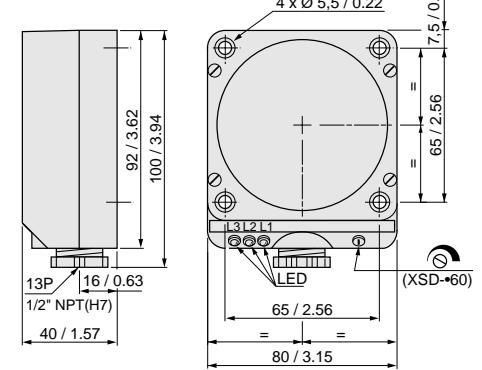

Operating temperature
 Température de fonctionnement
 Betriebstemperatur
 Temperatura de funcionamiento
 Temperatura di funzionamento
 Temperatura de funcionamento
 - 25 ... + 70 °C / - 13 ... + 158 °F

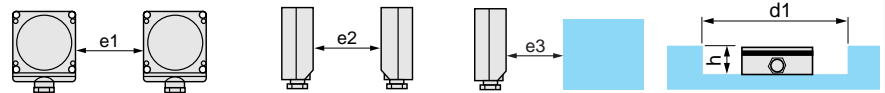

	Sn	e1 ≥	e2 ≥	e3 ≥	d1 ≥, h ≤
	XSD-40***8 40 / 1.57	200 / 7.87	400 / 15.74	200 / 7.87	82 / 3.23, 40 / 1.57
	XSD-50***8 50 / 1.97	250 / 9.84	500 / 19.68	200 / 7.87	82 / 3.23, 40 / 1.57
	XSD-40***9 40 / 1.57	200 / 7.87	400 / 15.74	200 / 7.87	400 / 15.74, 40 / 1.57
	XSD-50***9 50 / 1.97	250 / 9.84	500 / 19.68	200 / 7.87	400 / 15.74, 40 / 1.57
	XSD-60***9 30...60 / 1.18...2.36	300 / 11.81	-	200 / 7.87	400 / 15.74, 40 / 1.57

Electrical installation
 Mise en œuvre électrique
 Elektrische Installation
 Instalación eléctrica
 Messa in opera elettrica
 Instalação elétrica

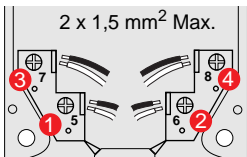

XSD-H•07339

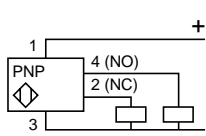

XSD-J•07339

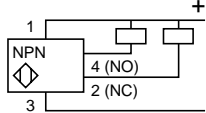

XSD-C607319

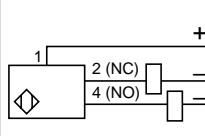

XSD-C40713•
XSD-C507139
XSD-C607139

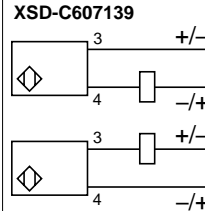

XSD-M500538
XSD-M600539

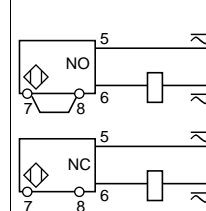

XSD-A400519
XSD-A600519

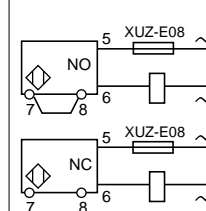

Voltage limits (1)	10...58 V	10...58 V	10...58 V	20...264 V	20...264 V
Load switching capacity (2)	0...200 mA	1.5...50 mA (*)	1.5...100 mA	5...100 mA ~ 5...500 mA	5...500 mA (*)
Voltage drop (3)	≤ 1,8 V	≤ 7 V	≤ 4 V	≤ 6 V	≤ 4,5V
Leakage current (4)	-	≤ 0,6...0,8 mA	≤ 0,5 mA	≤ 1,7 mA / 120 V ≤ 3 mA / ~ 240 V ≤ 1 mA / 24 V	≤ 1,7 mA / 120 V
Current consumption (5)	≤ 10 mA	-	-	-	-

(1) Limite de tension / Betriebsspannung / Límites de tensión / Limiti di tensione / Limites de tensão
 (2) Courant commuté / Schaltstrom / Intensidad conmutada / Corrente commuta / Corrente comutada
 (3) Tension de déchet / Spannungsfall (Ausgang durchgesteuert) / Tensión residual / Caduta di tensione / Tensão de defeito
 (4) Courant résiduel / Reststrom (Ausgang gesperrt) / Intensidad residual / Corrente residual / Corrente residual
 (5) Courant consommé / Leerlaufstrom / Intensidad consumida / Corrente consumata / Corrente consumida

(*) Without short circuit protection
 Non protégés court-circuit
 Ohne Kurzschlußschutz
 No protección cortocircuito
 Non protetto corto-circuito
 Não protecção curto-circuito

Installation precautions
 Précautions de mise en œuvre
 Vorsicht bei der Inbetriebnahme
 Precaution de installation
 Consigli di messa in opera
 Precaução de instalação

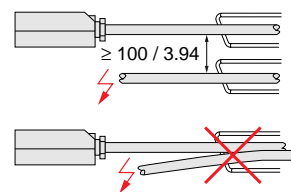
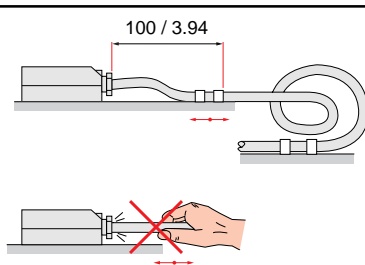

Indication, Signalisation
 Funktionsanzeige, Señalización
 Segnalazione, Sinalização

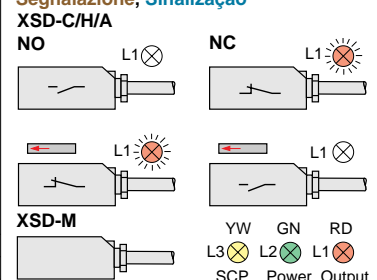

YWL3	Yellow	Jaune	Gerb	Amarillo	Giallo	Amarelo
GNL2	Green	Vert	Grün	Verde	Verde	Verde
RD/L1	Red	Rouge	Rot	Rojo	Rosso	Vermelho