

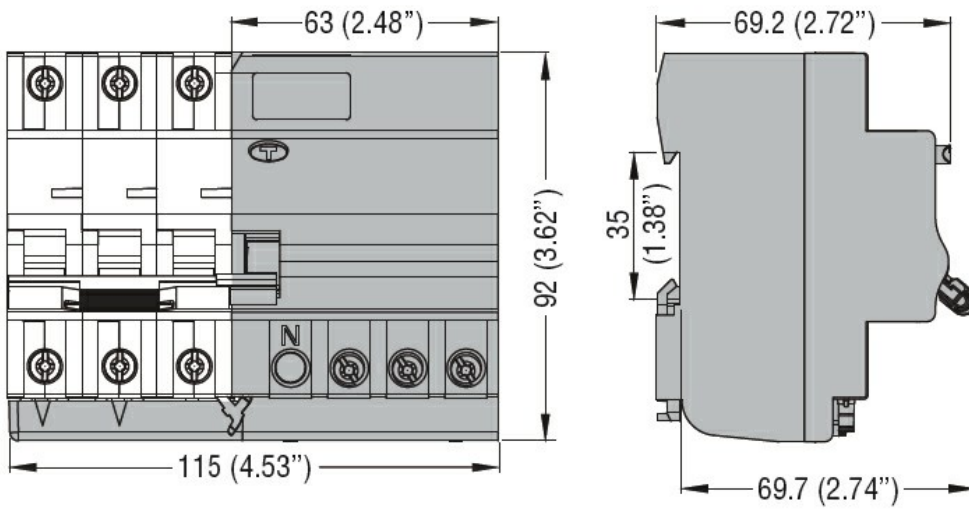

Product designation				Residual block add-on
Product type designation				P1 RA
Number of poles				3P
Number of DIN modules				3.5
Compliance				IEC
<b>Electrical features</b>				
Rated insulation voltage $U_i$ IEC/EN		V	400	
Rated impulse withstand voltage $U_{imp}$		kV	4	
Rated operational voltage AC (IEC)		VAC	230/400	
Rated frequency		Hz	50/60	
Rated current ( $I_n$ )		A	40	
Residual operation characteristic			A	
Rated residual current		mA	30	
Electrical life		cycles	10000	
<b>Ambient conditions</b>				
Operating temperature	min	°C	-25	
	max	°C	+60	
Storage temperature	min	°C	-40	
	max	°C	+80	
Max altitude		m	2000	
<b>Mechanical features</b>				
Operating position		normal	Vertical plan	
Fixing			35mm DIN rail	
Tightening torque for terminals	min	Nm	1.8	
	max	Nm	2	
	min	lbin	16	
	max	lbin	17.7	
Terminals tool			Pz 2	
Conductor section	IEC	min	mm <sup>2</sup>	1
		max	mm <sup>2</sup>	16
	AWG/Kcmil	min		14
		max		6
Mechanical life		cycles	20000	
Weight		g	205	
Frontal IP degree			IP20	
Pollution degree			2	
<b>Dimensions</b>				



**Certifications and compliance**

Compliance

IEC/EN 61009-1

Certifications

EAC

TÜV-SUD

**ETIM classification**

ETIM 8.0

EC002297 -  
 Residual current  
 circuit breaker  
 (RCCB) module