



Product designation	Power contactor		
Product type designation	BG09		
Contact characteristics			
Number of poles	Nr.	3	
Rated insulation voltage U_i IEC/EN	V	690	
Rated impulse withstand voltage U_{imp}	kV	6	
Operational frequency	min	Hz	25
	max	Hz	400
IEC Conventional free air thermal current I_{th}	A	20	
Operational current I_e	AC-1 ($\leq 40^\circ\text{C}$)	A	20
	AC-1 ($\leq 55^\circ\text{C}$)	A	18
	AC-1 ($\leq 70^\circ\text{C}$)	A	15
	AC-3 ($\leq 440\text{V} \leq 55^\circ\text{C}$)	A	9
	AC-4 (400V)	A	4
Rated operational power AC-3 ($T \leq 55^\circ\text{C}$)	230V	kW	2.2
	400V	kW	4
	415V	kW	4.3
	440V	kW	4.5
	500V	kW	5
	690V	kW	5
Rated operational power AC-1 ($T \leq 40^\circ\text{C}$)	230V	kW	8
	400V	kW	14
	500V	kW	16
	690V	kW	22
IEC max current I_e in DC1 with $L/R \leq 1\text{ms}$ with 1 poles in series	$\leq 24\text{V}$	A	12
	48V	A	10
	75V	A	4
	110V	A	3
	220V	A	–
IEC max current I_e in DC1 with $L/R \leq 1\text{ms}$ with 2 poles in series	$\leq 24\text{V}$	A	15
	48V	A	14
	75V	A	9
	110V	A	8
	220V	A	–
IEC max current I_e in DC1 with $L/R \leq 1\text{ms}$ with 3 poles in series	$\leq 24\text{V}$	A	16
	48V	A	16
	75V	A	10
	110V	A	10

	220V	A	2
IEC max current I _e in DC1 with L/R ≤ 1ms with 4 poles in series	≤24V	A	16
	48V	A	16
	75V	A	10
	110V	A	10
	220V	A	2
IEC max current I _e in DC3-DC5 with L/R ≤ 15ms with 1 poles in series	≤24V	A	7
	48V	A	6
	75V	A	2
	110V	A	1
	220V	A	–
IEC max current I _e in DC3-DC5 with L/R ≤ 15ms with 2 poles in series	≤24V	A	8
	48V	A	8
	75V	A	5
	110V	A	4
	220V	A	–
IEC max current I _e in DC3-DC5 with L/R ≤ 15ms with 3 poles in series	≤24V	A	10
	48V	A	10
	75V	A	6
	110V	A	5
	220V	A	0,8
IEC max current I _e in DC3-DC5 with L/R ≤ 15ms with 4 poles in series	≤24V	A	10
	48V	A	10
	75V	A	6
	110V	A	5
	220V	A	0,8
Short-time allowable current for 10s (IEC/EN60947-1)		A	96
Protection fuse	gG (IEC)	A	20
	aM (IEC)	A	10
Making capacity (RMS value)		A	92
Breaking capacity at voltage	440V	A	72
	500V	A	72
	690V	A	72
Resistance per pole (average value)		mΩ	10
Power dissipation per pole (average value)	I _{th}	W	4
	AC-3	W	0.81
Tightening torque for terminals	min	Nm	0.8
	max	Nm	1
	min	I _{bin}	9
	max	I _{bin}	9
Tightening torque for coil terminal	min	Nm	0.8
	max	Nm	1
	min	I _{bin}	9

		max	lbin	9
Max number of wires simultaneously connectable			Nr.	2
Conductor section	AWG/Kcmil	max		12
Flexible w/o lug conductor section		min	mm ²	0.75
		max	mm ²	2.5
Flexible c/w lug conductor section		min	mm ²	1.5
		max	mm ²	2.5
Flexible with insulated spade lug conductor section		min	mm ²	1.5
		max	mm ²	2.5
Power terminal protection according to IEC/EN 60529				IP20 when properly wired

Mechanical features

Operating position		normal allowable		Vertical plan ±30°
Fixing				Screw / DIN rail 35mm
Weight			g	214
Conductor section	AWG/kcmil conductor section	max		12

Auxiliary contact characteristics

Thermal current I _{th}		A		10
IEC/EN 60947-5-1 designation				A600 - Q600
Operating current AC15		230V	A	3
		400V	A	1.9
		500V	A	1.4
Operating current DC12		110V	A	2.9
Operating current DC13		24V	A	2.9
		48V	A	1.4
		60V	A	1.2
		110V	A	0.6
		125V	A	0.55
		220V	A	0.3
		600V	A	0.1

Operations

Mechanical life		cycles		20000000
Electrical life		cycles		500000

Safety related data

Performance level B10d according to EN/ISO 13489-1		rated load	cycles	500000
		mechanical load	cycles	20000000
Mirror contacts according to IEC/EN 60947-4-1				yes
EMC compatibility				yes

DC coil operating

DC rated control voltage		V	220
DC operating voltage			
	pick-up	min	%Us 75
		max	%Us 115
	drop-out	min	%Us 10
		max	%Us 25
Average coil consumption $\leq 20^{\circ}\text{C}$			
	in-rush	W	3.2
	holding	W	3.2

Max cycles frequency

Mechanical operation		cycles/h	3600
----------------------	--	----------	------

Operating times

Average time for Us control			
	in AC		
	Closing NO	min	ms 12
		max	ms 21
	Opening NO	min	ms 9
		max	ms 18
	Closing NC	min	ms 17
		max	ms 26
	Opening NC	min	ms 7
		max	ms 17
	in DC		
	Closing NO	min	ms 18
		max	ms 25
	Opening NO	min	ms 2
		max	ms 3
	Closing NC	min	ms 3
		max	ms 5
	Opening NC	min	ms 11
		max	ms 17

UL technical data

Full-load current (FLA) for three-phase AC motor			
	at 480V	A	7.6
	at 600V	A	6.1

Yielded mechanical performance			
	for single-phase AC motor		
	110/120V	HP	0.5
	230V	HP	1.5
	for three-phase AC motor		
	200/208V	HP	2
	220/230V	HP	3
	460/480V	HP	5
	575/600V	HP	5

General USE

Contactor	AC current	A	20
Short-circuit protection fuse, 600V High fault	Short circuit current	kA	100
	Fuse rating	A	30
	Fuse class		J
Standard fault	Short circuit current	kA	5
	Fuse rating	A	30
	Fuse class		RK5
Contact rating of auxiliary contacts according to UL			A600 - Q600

Ambient conditions

Temperature

Operating temperature

min	°C	-50
max	°C	+70

Storage temperature

min	°C	-60
max	°C	+80

Max altitude

m	3000
---	------

Resistance & Protection

Pollution degree

3

Dimensions

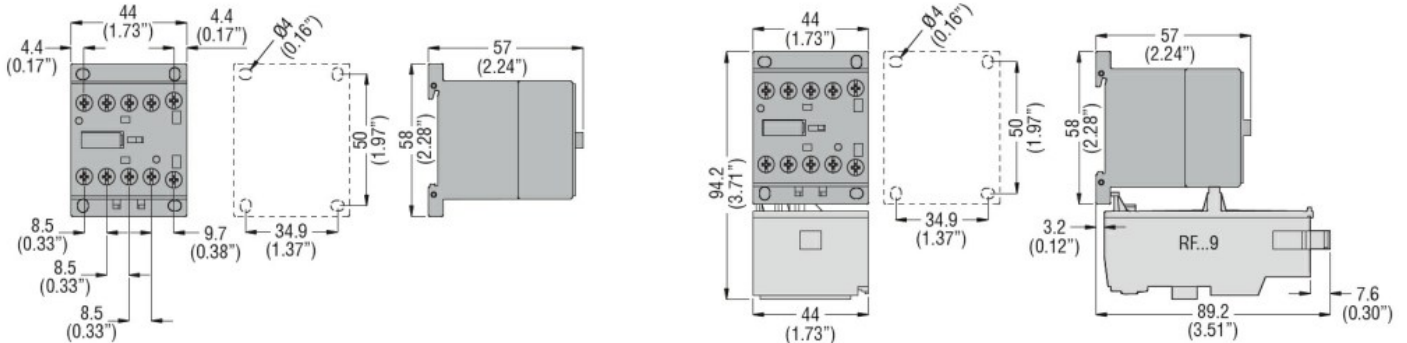

Wiring diagrams

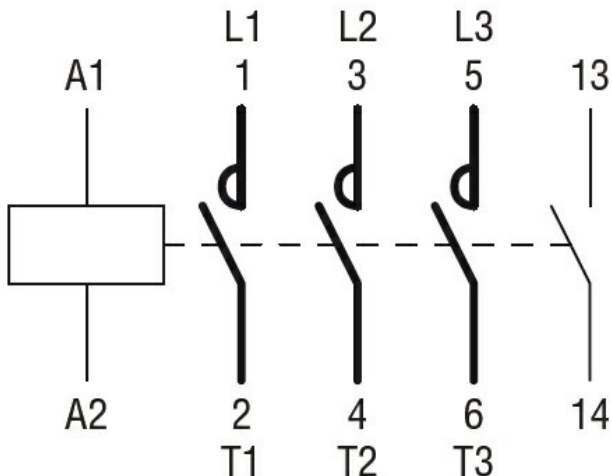

Certifications and compliance

Compliance

CSA C22.2 n° 60947-1

CSA C22.2 n° 60947-4-1

IEC/EN 60947-1

IEC/EN 60947-4-1

UL 60947-1

UL 60947-4-1

Certificates

CCC

cULus

EAC

ETIM classification

ETIM 8.0

EC000066 -
Power contactor,
AC switching