

Part number

CHP 16 LS



Surface mounting housing, C-TYPE series, with 1 lever, Pg21 cable entry, size "77.27", with metal cover

Product description		Material properties	
Product type	Surface mounting housing	Other materials	Lever: Stainless steel, polyamide (PA) Gasket: NBR
Series	C-TYPE	Colour	RAL 7040 grey
Closing type	With 1 lever	RoHs conformity	Compliant
Size	Size 77.27	China RoHs - EFUP	E
Cable entry	With cable entry Pg21	REACH SVHC substances	No
Specification	With metal cover	Approvals / Standards	
Technical data		Certifications	DNV, BV
IP degree of protection	IP65	UL	ECBT2
Further technical details		cUL	ECBT8
Weight	378,00 g	General ordering information	
Operating temperature range (min, max)	-40°C...+125°C	EAN13 code	8015747022231
		Packaging Information	
		Packaging length	475,00 mm
		Packaging height	180,00 mm
		Packaging width	175,00 mm
		Packaging weight	3,83 kg
		Packaging volume	14,96 dm ³
		Packaging description	Carton box
		Packaging quantity	10 Pcs
		Packaging EAN code	8015747022248
		Sub-packaging weight	1,92 kg
		Sub-packaging description	Plastic packaging
		Sub-packaging quantity	5 Pcs
		Sub-packaging EAN barcode	8015747022255

Part number

CHP 16 LS



Catalogue drawings

CHP L CAP L - MHP L MAP L



CHP LS CAP LS - MHP LS MAP LS

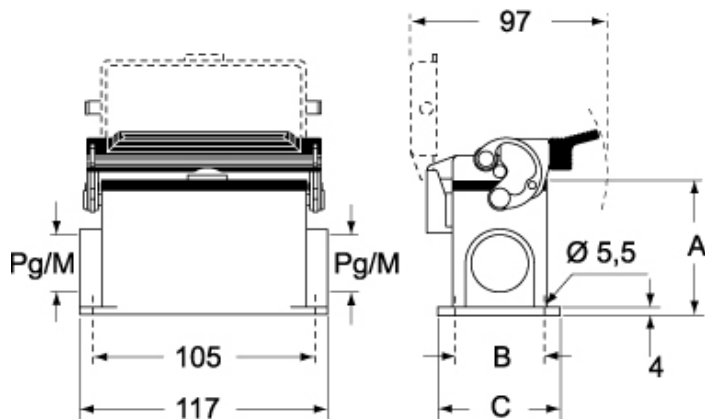

	A
CHP L / MHP L	63
CAP L / MAP L	77
CHP LS / MHP LS	63
CAP LS / MAP LS	77

Notes

Dimensions shown in mm are not binding and may be changed without notice.