



# AHM36I-S3CC014x12

AHS/AHM36

**ABSOLUTE ENCODERS**

**SICK**  
Sensor Intelligence.



Illustration may differ



### Ordering information

Type	Part no.
AHM36I-S3CC014x12	1099327

Other models and accessories → [www.sick.com/AHS\\_AHM36](http://www.sick.com/AHS_AHM36)

### Detailed technical data

#### Performance

<b>Number of steps per revolution (max. resolution)</b>	16,384 (14 bit)
<b>Number of revolutions</b>	4,096 (12 bit)
<b>Max. resolution (number of steps per revolution x number of revolutions)</b>	14 bit x 12 bit (16,384 x 4,096)
<b>Error limits G</b>	0.35° (at 20 °C) <sup>1)</sup>
<b>Repeatability standard deviation <math>\sigma_r</math></b>	0.2° (at 20 °C) <sup>2)</sup>

<sup>1)</sup> In accordance with DIN ISO 1319-1, position of the upper and lower error limit depends on the installation situation, specified value refers to a symmetrical position, i.e. deviation in upper and lower direction is the same.

<sup>2)</sup> In accordance with DIN ISO 55350-13; 68.3% of the measured values are inside the specified area.

#### Interfaces

<b>Communication interface</b>	CANopen
<b>Data protocol</b>	CANopen CiA DS-301 V4.02, CiA DSP-305 LSS, Encoder Profile: - CiA DS-406, V3.2. - Class C2
<b>Address setting</b>	0 ... 127, default: 5
<b>Data transmission rate (baud rate)</b>	20 kbit/s ... 1,000 kbit/s, default: 125 kbit/s
<b>Initialization time</b>	2 s <sup>1)</sup>
<b>Process data</b>	Position, speed, Temperature
<b>Parameterising data</b>	Number of steps per revolution Number of revolutions PRESET Counting direction Sampling rate for speed calculation Unit for output of the speed value Round axis functionality Electronic cams(2 channels x 8 cams)
<b>Available diagnostics data</b>	Minimum and maximum temperature Maximum speed Power-on counter Operating hours counter power-on/motion

<sup>1)</sup> Valid positional data can be read once this time has elapsed.

<sup>2)</sup> See accessories.

	Counter of direction changes/number of movements cw/number of movements ccw Minimum and maximum operating voltage
<b>Status information</b>	CANopen status via status LED
<b>Bus termination</b>	Via external terminator <sup>2)</sup>

<sup>1)</sup> Valid positional data can be read once this time has elapsed.

<sup>2)</sup> See accessories.

## Electrical data

<b>Connection type</b>	Male connector, M12, 5-pin, universal
<b>Supply voltage</b>	10 ... 30 V
<b>Power consumption</b>	≤ 1.5 W (without load)
<b>Reverse polarity protection</b>	✓
<b>MTTFd: mean time to dangerous failure</b>	270 years (EN ISO 13849-1) <sup>1)</sup>

<sup>1)</sup> This product is a standard product and does not constitute a safety component as defined in the Machinery Directive. Calculation based on nominal load of components, average ambient temperature 40 °C, frequency of use 8760 h/a. All electronic failures are considered hazardous. For more information, see document no. 8015532.

## Mechanical data

<b>Mechanical design</b>	Solid shaft, face mount flange
<b>Shaft diameter</b>	6 mm
<b>Shaft length</b>	12 mm
<b>Weight</b>	0.2 kg <sup>1)</sup>
<b>Shaft material</b>	Stainless steel 1,4305
<b>Flange material</b>	Stainless steel 1,4305
<b>Housing material</b>	Stainless steel 1,4305
<b>Start up torque</b>	1 Ncm (+20 °C)
<b>Operating torque</b>	< 1 Ncm (+20 °C)
<b>Permissible shaft loading</b>	40 N (radial) 20 N (axial)
<b>Operating speed</b>	≤ 6,000 min <sup>-1</sup> <sup>2)</sup>
<b>Moment of inertia of the rotor</b>	2.5 gcm <sup>2</sup>
<b>Bearing lifetime</b>	3.6 x 10 <sup>8</sup> revolutions
<b>Angular acceleration</b>	≤ 500,000 rad/s <sup>2</sup>

<sup>1)</sup> Based on devices with male connector.

<sup>2)</sup> Allow for self-heating of 3.5 K per 1,000 rpm when designing the operating temperature range.

## Ambient data

<b>EMC</b>	According to EN 61000-6-2 and EN 61000-6-3
<b>Enclosure rating</b>	IP67 (IEC 60529) IP69K (IEC 60529)
<b>Permissible relative humidity</b>	90 % (Condensation not permitted)
<b>Operating temperature range</b>	-40 °C ... +85 °C
<b>Storage temperature range</b>	-40 °C ... +100 °C, without package
<b>Resistance to shocks</b>	100 g, 6 ms (EN 60068-2-27)

<sup>1)</sup> For side-mounted encoders (horizontal encoder shaft, vertical stator coupling), additional damping measures may be required in some cases as resonances can arise. Furthermore, the cable must be fastened with the shortest possible distance to the encoder.

<b>Resistance to vibration</b>	20 g, 10 Hz ... 2,000 Hz (EN 60068-2-6) <sup>1)</sup>
--------------------------------	---

<sup>1)</sup> For side-mounted encoders (horizontal encoder shaft, vertical stator coupling), additional damping measures may be required in some cases as resonances can arise. Furthermore, the cable must be fastened with the shortest possible distance to the encoder.

### Classifications

<b>ECLASS 5.0</b>	27270502
<b>ECLASS 5.1.4</b>	27270502
<b>ECLASS 6.0</b>	27270590
<b>ECLASS 6.2</b>	27270590
<b>ECLASS 7.0</b>	27270502
<b>ECLASS 8.0</b>	27270502
<b>ECLASS 8.1</b>	27270502
<b>ECLASS 9.0</b>	27270502
<b>ECLASS 10.0</b>	27270502
<b>ECLASS 11.0</b>	27270502
<b>ECLASS 12.0</b>	27270502
<b>ETIM 5.0</b>	EC001486
<b>ETIM 6.0</b>	EC001486
<b>ETIM 7.0</b>	EC001486
<b>ETIM 8.0</b>	EC001486
<b>UNSPSC 16.0901</b>	41112113

### Dimensional drawing (Dimensions in mm (inch))

Solid shaft, face mount flange, male connector

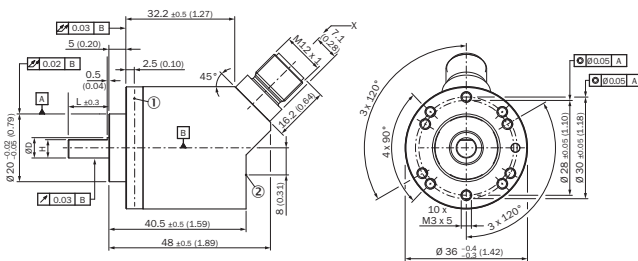

Non-tolerated dimensions according to DIN-ISO 2768-mk

- ① Measuring point for operating temperature
- ② Measuring point for vibrations

Type	Shaft diameter Ø D f7	B	H
AHx36x-S1xxxxxxxx AHx36x-S3xxxxxxxx	6 mm	3,6 mm	5,4 mm
AHx36x-S9xxxxxxxx AHx36x-S5xxxxxxxx	8 mm	3,9 mm	7,5 mm
AHx36x-S2xxxxxxxx AHx36x-S4xxxxxxxx AHx36x-SCxxxxxxxx	10 mm	6 mm	9 mm
AHx36x-SAxxxxxxxx AHx36x-S8xxxxxxxx	1/4"	3,85 mm	5,7 mm

Type	Shaft diameter Ø D f7	B	H
AHx36x-SBxxxxxxx AHx36x-S7xxxxxxx	3/8"	4,35 mm	9 mm

### Attachment specifications

Solid shaft, face mount flange with flange adapter, centering collar D20 on D24 (BEF-FA-020-024-I, 2103982)

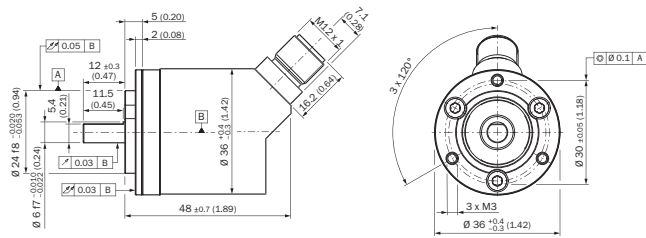

Order example for 6 mm shaft diameter: AHx36I-S3xx0xxxx + BEF-FA-020-024-I (adapter is not pre-assembled)

Solid shaft, face mount flange with flange adapter, centering collar D20 on D36, 2 mm high (BEF-FA-020-036-2-I, 2103984)

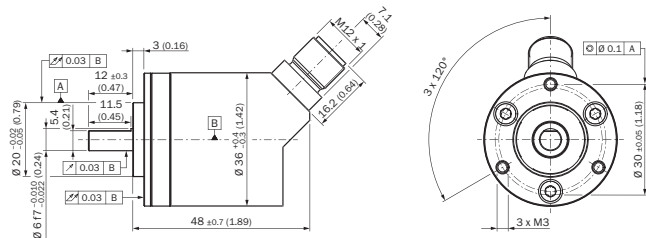

Order example for 6 mm shaft diameter: AHx36I-S3xx0xxxx + BEF-FA-020-036-2-I (adapter is not pre-assembled)

Solid shaft, face mount flange with flange adapter, centering collar D20 on D50 (BEF-FA-020-050-I, 2103985)

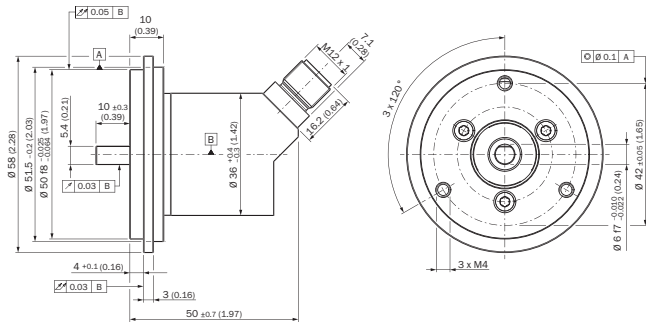

Order example for 6 mm shaft diameter: AHx36I-S3xx0xxxx + BEF-FA-020-050-I (adapter is not pre-assembled)

### PIN assignment

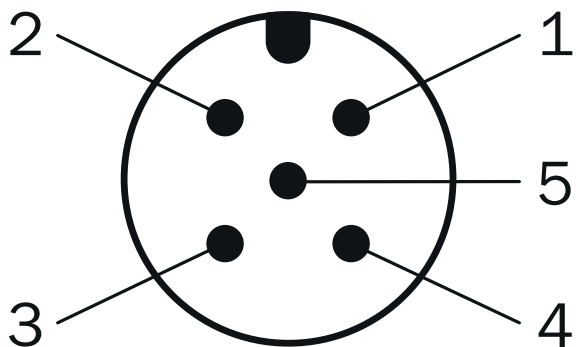











PIN	Signal	Wire colors (cable connection)	Function
1	CAN Shield	White	Screen
2	VDC	Red	Supply voltage Encoder 10 V DC ... 30 V DC
3	GND/CAN GND	Blue	0 V (GND)
4	CAN high	Black	CAN signal
5	CAN low	Pink	CAN signal
Housing	-	-	Screen

### Recommended accessories

Other models and accessories → [www.sick.com/AHS\\_AHM36](http://www.sick.com/AHS_AHM36)

	Brief description	Type	Part no.
Plug connectors and cables			
	<ul style="list-style-type: none"> <li><b>Connection type head A:</b> Female connector, M12, 5-pin, straight, A-coded</li> <li><b>Signal type:</b> Fieldbus</li> <li><b>Cable:</b> 2 m, 4-wire, PUR, halogen-free</li> <li><b>Description:</b> Fieldbus, shielded</li> <li><b>Application:</b> Drag chain operation, Zones with oils and lubricants</li> </ul>	YF2A55-020C1BXLEAX	2107874
	<ul style="list-style-type: none"> <li><b>Connection type head A:</b> Female connector, M12, 5-pin, angled, A-coded</li> <li><b>Signal type:</b> Fieldbus</li> <li><b>Cable:</b> 2 m, 4-wire, PUR, halogen-free</li> <li><b>Description:</b> Fieldbus, shielded</li> <li><b>Application:</b> Drag chain operation, Zones with oils and lubricants</li> </ul>	YG2A55-020C1BXLEAX	2107899
	<ul style="list-style-type: none"> <li><b>Connection type head A:</b> Female connector, M12, 5-pin, straight, A-coded</li> <li><b>Connection type head B:</b> Male connector, M12, 5-pin, straight, A-coded</li> <li><b>Signal type:</b> Fieldbus</li> <li><b>Cable:</b> 2 m, 4-wire, PUR, halogen-free</li> <li><b>Description:</b> Fieldbus, shielded</li> <li><b>Application:</b> Drag chain operation, Zones with oils and lubricants</li> </ul>	YF2A55-020C1BM2A55	2107898

	Brief description	Type	Part no.
	<ul style="list-style-type: none"> <li><b>Connection type head A:</b> Female connector, M12, 5-pin, angled, A-coded</li> <li><b>Connection type head B:</b> Male connector, M12, 5-pin, straight, A-coded</li> <li><b>Signal type:</b> Fieldbus</li> <li><b>Cable:</b> 2 m, 4-wire, PUR, halogen-free</li> <li><b>Description:</b> Fieldbus, shielded</li> <li><b>Application:</b> Drag chain operation, Zones with oils and lubricants</li> </ul>	YG2A55-020C1BM2A55	2107901
	<ul style="list-style-type: none"> <li><b>Connection type head A:</b> Female connector, M12, 5-pin, straight, A-coded</li> <li><b>Description:</b> Shielded</li> <li><b>Connection systems:</b> Screw-type terminals</li> <li><b>Permitted cross-section:</b> ≤ 0.75 mm<sup>2</sup></li> <li><b>Application:</b> Hygienic and washdown zones</li> </ul>	YF12ES5-0075S5586A	2097335
	<ul style="list-style-type: none"> <li><b>Connection type head A:</b> Male connector, M12, 5-pin, straight, A-coded</li> <li><b>Description:</b> Shielded</li> <li><b>Connection systems:</b> Screw-type terminals</li> <li><b>Permitted cross-section:</b> ≤ 0.75 mm<sup>2</sup></li> <li><b>Application:</b> Hygienic and washdown zones</li> </ul>	YM12ES5-0075S5586A	2097336
<b>Shaft adaptation</b>			
	Bellows coupling, shaft diameter 6 mm / 6 mm, maximum shaft offset: radial ± 0.25 mm, axial ± 0.4 mm, angular +/- 4°; max. speed 10,000 rpm, -30 °C to +120 °C, max. torque 120 Ncm; material: stainless steel bellows, aluminum hub	KUP-0606-B	5312981
	Double-loop coupling, shaft diameter 6 mm / 6 mm, maximum shaft offset: radial ± 2.5 mm, axial ± 3 mm, angular ± 10°; max. speed 3,000 rpm, -30 °C to +80 °C, max. torque 1.5 Nm; material: polyurethane, galvanized steel flange	KUP-0606-D	5340152
	Claw coupling, shaft diameter 6 mm / 6 mm, damping element 80 shore blue, maximum shaft offset: radial ± 0.22 mm, axial ± 1 mm angular ± 1.3°, max. speed 19,000 rpm, angle of twist max. 10°, -30 °C to +80 °C, max. torque 800 Ncm, tightening torque of screws: ISO 4029 150 Ncm, material: aluminum flange, damping element: polyurethane	KUP-0606-J	2127057
	Bellows coupling, shaft diameter 6 mm / 10 mm, maximum shaft offset: radial ± 0.25 mm, axial ± 0.4 mm, angular +/- 4°; max. speed 10,000 rpm, -30 °C to +120 °C, max. torque 120 Ncm; material: stainless steel bellows, aluminum hub	KUP-0610-B	5312982
	Double loop coupling, shaft diameter 6 mm / 10 mm, max. shaft offset: radially +/- 2.5 mm, axially +/- 3 mm, angle +/- 10 degrees; max. speed 3.000 rpm, -30 to +80 degrees Celsius, torsional spring stiffness of 25 Nm/rad	KUP-0610-D	5326697
	Spring washer coupling, shaft diameter 6 mm / 10 mm, Maximum shaft offset: radial +/- 0.3 mm, axial +/- 0.4 mm, angular +/- 2.5°; max. speed 12,000 rpm, -10° to +80 °C, max. torque 60 Ncm; material: aluminum flange, glass fiber-reinforced polyamide membrane and hardened steel coupling pin	KUP-0610-F	5312985
	Claw coupling, shaft diameter 6 mm / 10 mm, damping element 80 shore blue, maximum shaft offset: radial ± 0.22 mm, axial ± 1 mm angular ± 1.3°, max. speed 19,000 rpm, angle of twist max. 10°, -30 °C to +80 °C, max. torque 800 Ncm, tightening torque of screws: ISO 4029 150 Ncm, material: aluminum flange, damping element: polyurethane	KUP-0610-J	2127056
<b>Others</b>			
	<ul style="list-style-type: none"> <li><b>Connection type head A:</b> Female connector, M12, 5-pin, straight</li> <li><b>Connection type head B:</b> Female connector, D-Sub, 9-pin, straight</li> <li><b>Signal type:</b> CANopen</li> <li><b>Description:</b> CANopen, shielded, Adapter cable for encoders and inclination sensors with CANopen interface and M12</li> <li><b>Note:</b> Programming adapter cable for programming tool PGT-12-Pro</li> </ul>	DDL-2D05-G0M5BC9	2083805

## SICK AT A GLANCE

SICK is one of the leading manufacturers of intelligent sensors and sensor solutions for industrial applications. A unique range of products and services creates the perfect basis for controlling processes securely and efficiently, protecting individuals from accidents and preventing damage to the environment.

We have extensive experience in a wide range of industries and understand their processes and requirements. With intelligent sensors, we can deliver exactly what our customers need. In application centers in Europe, Asia and North America, system solutions are tested and optimized in accordance with customer specifications. All this makes us a reliable supplier and development partner.

Comprehensive services complete our offering: SICK LifeTime Services provide support throughout the machine life cycle and ensure safety and productivity.

For us, that is “Sensor Intelligence.”

## WORLDWIDE PRESENCE:

Contacts and other locations –[www.sick.com](http://www.sick.com)