



# TR4-SDM01CB

TR4 Direct

NON-CONTACT SAFETY SWITCHES

**SICK**  
Sensor Intelligence.



### Ordering information

Type	Part no.
TR4-SDM01CB	6070805

Other models and accessories → [www.sick.com/TR4\\_Direct](http://www.sick.com/TR4_Direct)



### Detailed technical data

#### Features

<b>System part</b>	Sensor with actuator
<b>Sensor principle</b>	RFID
<b>Number of safe outputs</b>	2
<b>Safe switch on distance <math>S_{ao}</math></b>	15 mm
<b>Safe switch off distance <math>S_{ar}</math></b>	25 mm
<b>Active sensor surfaces</b>	2
<b>Actuation directions</b>	5
<b>Coding</b>	Universally coded

#### Safety-related parameters

<b>Safety integrity level</b>	SIL 3 (IEC 61508)
<b>Category</b>	Category 4 (EN ISO 13849)
<b>Performance level</b>	PL e (EN ISO 13849)
<b>PFH<sub>D</sub> (mean probability of a dangerous failure per hour)</b>	$6.03 * 10^{-10}$
<b>T<sub>M</sub> (mission time)</b>	20 years (EN ISO 13849)
<b>Type</b>	Type 4 (EN ISO 14119)
<b>Actuator coding level</b>	Low coding level (EN ISO 14119)
<b>Classification in compliance with IEC/EN 60947-5-3</b>	PDF-M
<b>Safe state in the event of a fault</b>	At least one safety-related semiconductor output (OSSD) is in the OFF state.

#### Functions

<b>Safe series connection</b>	With Flexi Loop (with diagnostics) With T-connector (without diagnostics)
-------------------------------	--

#### Interfaces

<b>Connection type</b>	Cable with plug M12, 8-pin
Length of cable	0.2 m
Long connecting cable	≤ 200 m

<sup>1)</sup> Detection time for external faults (e.g., short-circuit or cross-circuit of output signal switching devices). Follow the detailed information in the operating instructions.

Cable diameter	6.5 mm
Conductor cross section	0.25 mm <sup>2</sup>
Bend radius (with fixed installation)	> 7 x cable diameter
Bend radius (with moving cable)	> 14 x cable diameter
Cable material	PVC
Conductor material	Copper
Coupling nut material	Nickel-plated brass
<b>IO-Link Safety</b>	
OFDT	≤ 100 ms <sup>1)</sup>
<b>Display elements</b>	LEDs
Status display	✓

<sup>1)</sup> Detection time for external faults (e.g., short-circuit or cross-circuit of output signal switching devices). Follow the detailed information in the operating instructions.

### Electrical data

<b>Protection class</b>	III (EN 50178)
<b>Classification according to cULus</b>	Class 2
<b>Supply voltage V<sub>s</sub></b>	24 V DC (20.4 V DC ... 26.4 V DC)
<b>Power consumption</b>	≤ 50 mA
<b>Type of output</b>	Self-monitoring semiconductor outputs (OSSDs)
<b>Output current</b>	≤ 200 mA
<b>Response time</b>	45 ms <sup>1)</sup>
<b>Release time</b>	360 ms <sup>2)</sup>
<b>Risk time</b>	≤ 100 ms <sup>3)</sup>
<b>Switch-on time</b>	2 s <sup>4)</sup>
<b>Electrical life</b>	10 x 10 <sup>6</sup> switching cycles

<sup>1)</sup> In a safe series connection, each downstream safety switch increases the system response time. More response times can be found in the operating instructions.

<sup>2)</sup> Response time on approach to the enable zone.

<sup>3)</sup> Detection time for external faults (e.g., short-circuit or cross-circuit of output signal switching devices). Follow the detailed information in the operating instructions.

<sup>4)</sup> After application of the supply voltage to the safety switch.

### Mechanical data

<b>Design</b>	Rectangular
<b>Dimensions (W x H x D)</b>	25 mm x 88 mm x 20 mm
<b>Weight</b>	112 g
<b>Housing material</b>	Valox® DR48

### Ambient data

<b>Enclosure rating</b>	IP67 (IEC 60529) IP69K (ISO 20653)
<b>Ambient operating temperature</b>	-25 °C ... +70 °C
<b>Vibration resistance</b>	10 Hz ... 55 Hz, 3.5 mm (IEC 60068-2-6)
<b>Shock resistance</b>	30 g, 11 ms (EN 60068-2-27)

### Classifications

<b>ECLASS 5.0</b>	27272403
-------------------	----------

<b>ECLASS 5.1.4</b>	27272403
<b>ECLASS 6.0</b>	27272403
<b>ECLASS 6.2</b>	27272403
<b>ECLASS 7.0</b>	27272403
<b>ECLASS 8.0</b>	27272403
<b>ECLASS 8.1</b>	27272403
<b>ECLASS 9.0</b>	27272403
<b>ECLASS 10.0</b>	27272403
<b>ECLASS 11.0</b>	27272403
<b>ECLASS 12.0</b>	27274601
<b>ETIM 5.0</b>	EC001829
<b>ETIM 6.0</b>	EC001829
<b>ETIM 7.0</b>	EC001829
<b>ETIM 8.0</b>	EC001829
<b>UNSPSC 16.0901</b>	39122205

### Dimensional drawing (Dimensions in mm (inch))

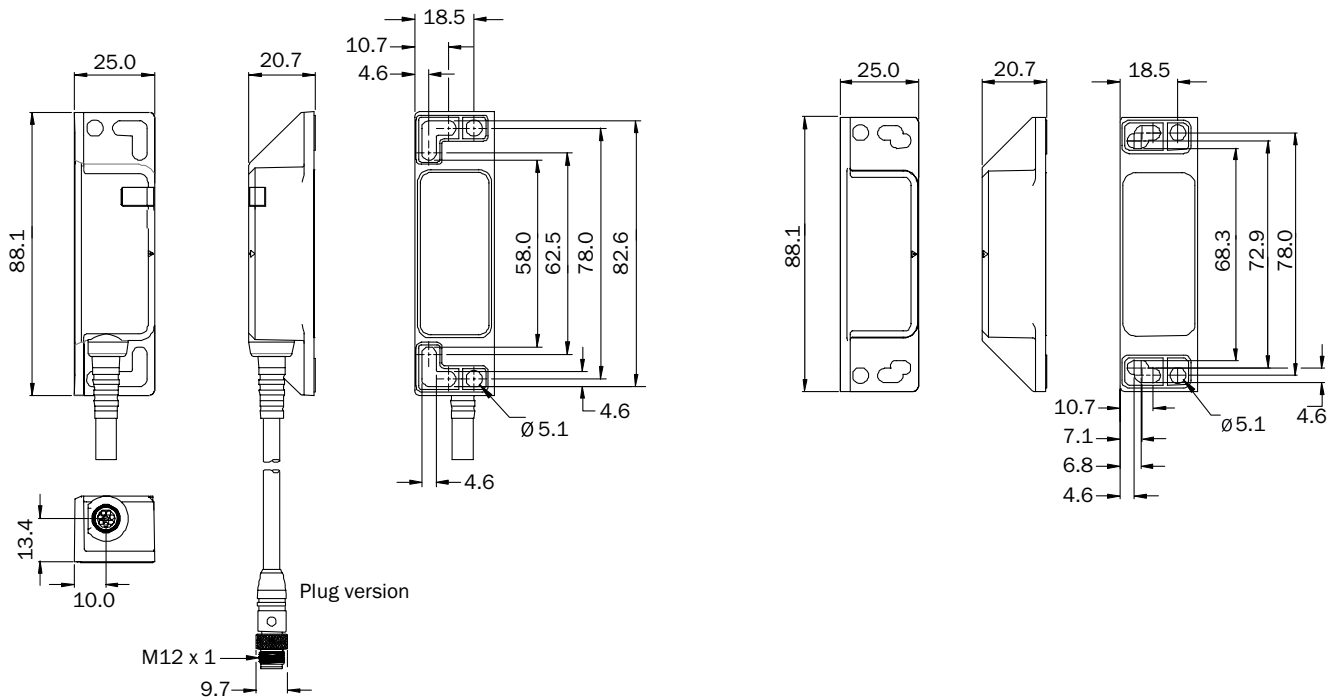

## Response range

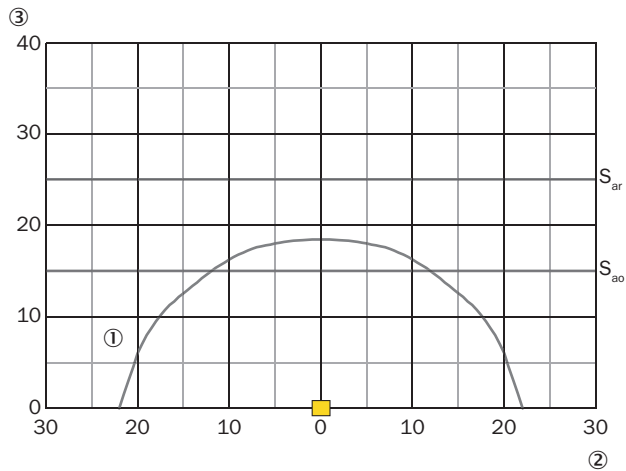

- ① Sensing range
- ② Side deviation in mm
- ③ Distance to sensor surface

## Pin assignment

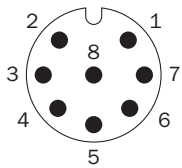

1	Aux output (not safe)
2	Voltage supply 24 V DC
3	Not connected
4	Enable input for OSSD 2
5	OSSD 1
6	OSSD 2
7	Voltage supply 0 V DC
8	Enable input for OSSD 1

## Connection single sensor

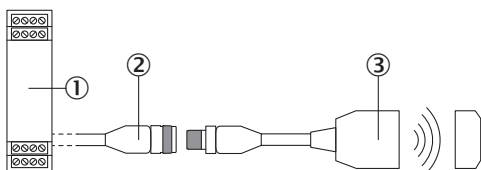

- ① Safe evaluation unit
- ② Connecting cable with M12 female connector, 8-pin and flying leads (e.g. YF2A18-xxxUA5LEAX)
- ③ TR4 Direct RFID safety switch (e.g., TR4-Sxx01C)

## Series connection

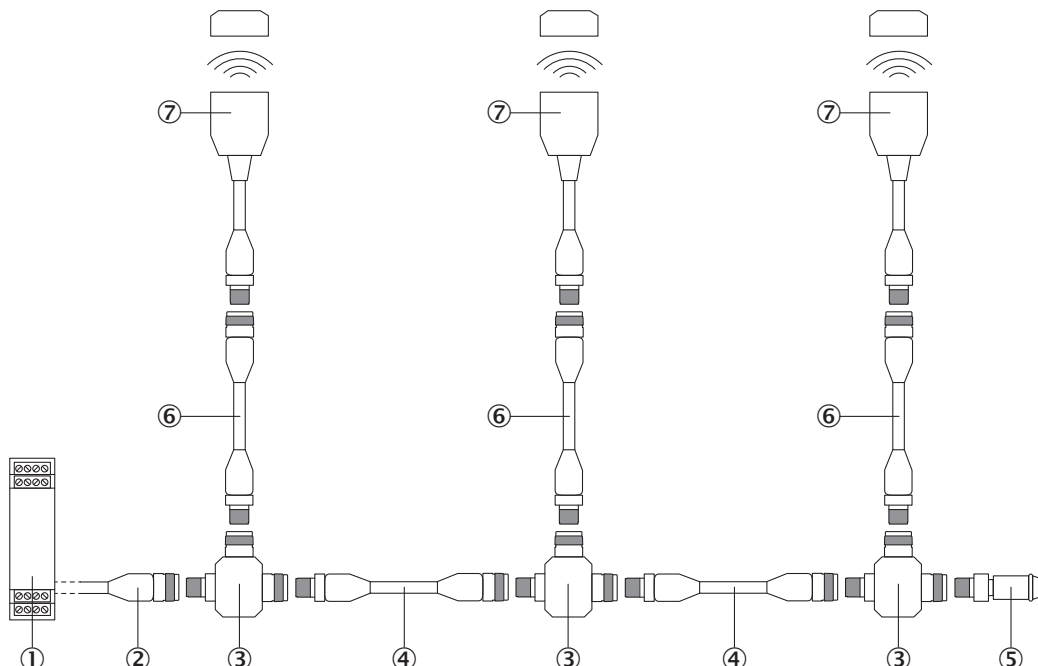

Series connection with T-piece (without diagnostics)



- ① Safe evaluation unit
- ② Connecting cable with M12 female connector, 4-pin and flying leads (e.g. YF2A14-xxxVB3XLEAX)
- ③ STR1-XXA T-connector
- ④ Connection cable with 4-pin, M12 male connector and 4-pin, M12 female connector (e.g., YF2A14-xxxVB3M2A14)
- ⑤ MLP1-XXT end connector
- ⑥ Connection cable with 8-pin, M12 male connector and 8-pin, M12 female connector (e.g., YF2A18-xxxUA5M2A18)
- ⑦ TR4 Direct RFID safety switch (e.g., TR4-Sxx01C)

## Recommended accessories

Other models and accessories → [www.sick.com/TR4\\_Direct](http://www.sick.com/TR4_Direct)

Brief description	Type	Part no.
Others		
 <ul style="list-style-type: none"> <li><b>Connection type head A:</b> Female connector, M12, 8-pin, straight, A-coded</li> <li><b>Connection type head B:</b> Flying leads</li> <li><b>Signal type:</b> Sensor/actuator cable</li> <li><b>Cable:</b> 2 m, 8-wire, PUR, halogen-free</li> <li><b>Description:</b> Sensor/actuator cable, unshielded</li> <li><b>Application:</b> Zones with oils and lubricants, Drag chain operation, Robot</li> </ul>	YF2A18-020UA5XLEAX	2095652
 <ul style="list-style-type: none"> <li><b>Connection type head A:</b> Female connector, M12, 8-pin, straight, A-coded</li> <li><b>Connection type head B:</b> Flying leads</li> <li><b>Signal type:</b> Sensor/actuator cable</li> <li><b>Cable:</b> 5 m, 8-wire, PUR, halogen-free</li> <li><b>Description:</b> Sensor/actuator cable, unshielded</li> <li><b>Application:</b> Zones with oils and lubricants, Drag chain operation, Robot</li> </ul>	YF2A18-050UA5XLEAX	2095653

	Brief description	Type	Part no.
	<ul style="list-style-type: none"> <li>• <b>Connection type head A:</b> Female connector, M12, 8-pin, straight, A-coded</li> <li>• <b>Connection type head B:</b> Flying leads</li> <li>• <b>Signal type:</b> Sensor/actuator cable</li> <li>• <b>Cable:</b> 10 m, 8-wire, PUR, halogen-free</li> <li>• <b>Description:</b> Sensor/actuator cable, unshielded</li> <li>• <b>Application:</b> Zones with oils and lubricants, Drag chain operation, Robot</li> </ul>	YF2A18-100UA5XLEAX	2095654

## SICK AT A GLANCE

SICK is one of the leading manufacturers of intelligent sensors and sensor solutions for industrial applications. A unique range of products and services creates the perfect basis for controlling processes securely and efficiently, protecting individuals from accidents and preventing damage to the environment.

We have extensive experience in a wide range of industries and understand their processes and requirements. With intelligent sensors, we can deliver exactly what our customers need. In application centers in Europe, Asia and North America, system solutions are tested and optimized in accordance with customer specifications. All this makes us a reliable supplier and development partner.

Comprehensive services complete our offering: SICK LifeTime Services provide support throughout the machine life cycle and ensure safety and productivity.

For us, that is “Sensor Intelligence.”

## WORLDWIDE PRESENCE:

Contacts and other locations –[www.sick.com](http://www.sick.com)