



**Connection kits for joining all types of DEVI
self-limiting heating cables to cold tails**

Fitting set (art. no. 19805761)

Cold tail fitting set:

- 1 crimp tube type 12/3, L = 20 mm
- 2 crimp tubes, type 3/1, L = 15 mm
- 3 squeeze connection tubes, type fitcrimp 1
- 1 crimp tube, type ESP 18/6, L = 125 mm

Sealing set for cable-end:

- 1 crimp tube, type ESP 12/4, L = 60 mm
- 1 crimp tube, type ESP 12/4, L = 25 mm
- 1 crimp tube, type KYNAR 3/4, L = 100 mm
- 1 piece of adhesive tape, L = 100 mm
- 1 piece of assembly wire

Practical fitting instructions

It is very essential to follow this instruction very carefully that when finished no connections are missing or wrong with the risk of the cable not working or being overheated.

Therefore, read the entire instruction to the end before you start.

A temperature of $150^{\circ}\text{C} \pm 30^{\circ}$ is necessary to shrink the crimp tubes. A hot air gun with a temperature regulator is the most appropriate tool.

However, a blow torch with a moderate flame or a gas lighter can also be used.

Preparation of the heating cable

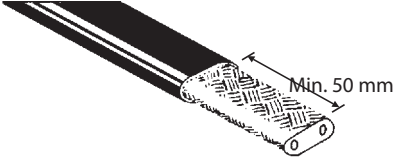
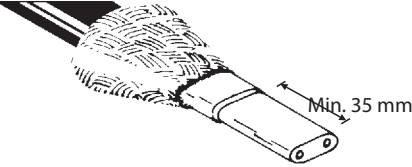
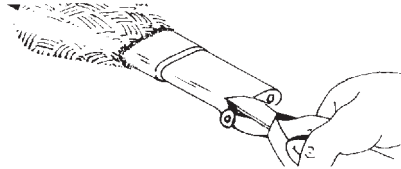
	1. Remove the outer sheath from the cable with a wire stripper.
	2. Pull the screen back over the cable and cut away, (with a knife) the conductor insulation.
	3. Using side-cutting pliers, carefully cut the inner layer of the material between the two conductors away, making sure not to damage them when doing so.



4. Pull the conductors to the side and cut the inner layer away so that it is flush with the first layer of insulation.



5. Twist the conductors so that the remaining material loosens.

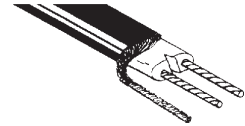

6. Carefully cut away any remaining material and trim the tips of the conductors. Cut a small triangle in the inner material as shown in the diagram.

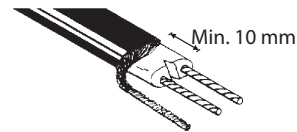

7. Untangle the screen and then twist it together. Position it as shown in the diagram. Make sure that none of the earth wires are in contact with the conductors.

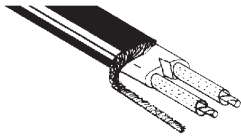

8. Mount the crimp tube, type 3/1, L=15 mm, onto the conductors.

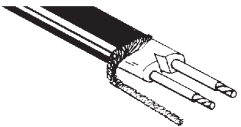

9. Crimp the tubes

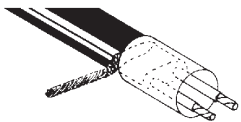

10. Pull the crimp tube, type 12/3, L = 20 mm over the cable so that it meets the outer sheath at the one end and protrudes at least 5 mm out over the inner layer of material at the other end.

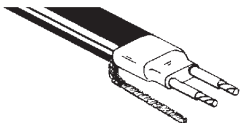

11. Crimp the tube.

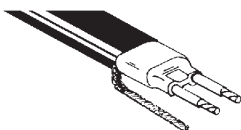

12. Press the tube with flat bit pliers between the conductors until glue is visible.

Preparation of the cold tail

All authorised electrical heating cables with an earth wire can be used.

1. Remove 50 mm of the outer sheath of the cable.
2. Free the conductors from the filler.
3. Cut away 25 mm from each conductor and remove 7 mm of the sheath from each of them.
4. Pull the crimp tube 19/6, L= 125 mm over the cold tail.

Assembling

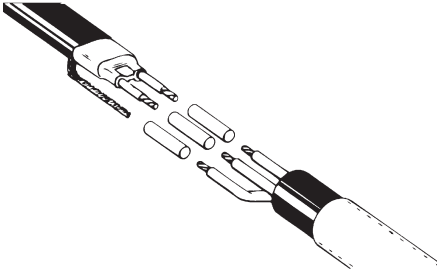

1. The conductors are joined together with the help of squeeze connection tubes. Warm the squeeze connection tubes until the tubes crimp and the glue flows.
2. Join the two earth wires together with the remaining squeeze connection tube.
3. Place the crimp tube, type 19/6 L = 125 mm over the joint in a central position.
4. Crimp the tube from the middle to the edges so that the glue is clearly visible.
5. Allow the join to cool down to body temperature before measuring the cable for its ohmic value.

Sealing the end of the heating cable

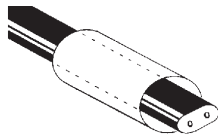
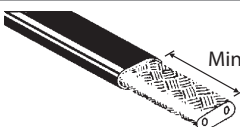
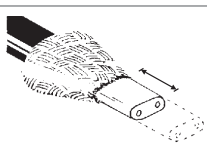
	1. Cut the cable to the desired length for installation.
	2. Remove the outer sheath from the cable.
	3. Pull the screen back over the cable.

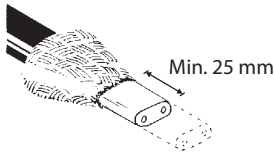

4. Cut away 25 mm from the inner part of cable.

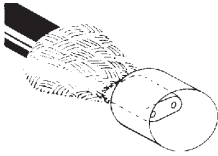

5. Pull the crimp tube, type 12/3, L=25 mm over the remaining inner part of the cable.

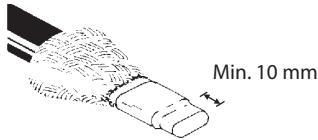

6. Crimp the tube down and flatten the end with flat bit pliers so that the glue is visible.

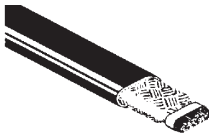

7. Pull the screen back over the cable and secure with the provided assembly wire.

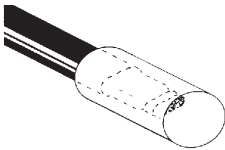

8. Pull the crimp, type 12/3 L= 60 mm over the cable and allow 10 mm to protrude over the end of the cable.

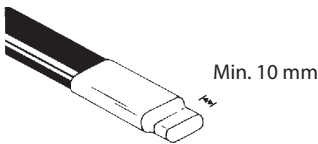

9. Crimp the tube down and pinch the end with flat bit pliers so that the glue is clearly visible.

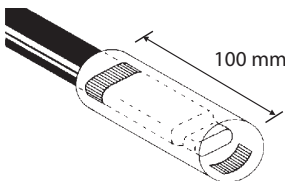

10. Sealing the end of the heating cable for damp and particularly aggressive conditions, e.g roof gutters, chemical plants, etc. requires that the flowing is mounted over the seal:

- a. Wrap 8 cm of adhesive tape around the outside sheath of the cable so that it overlaps the crimped tube. Pull the crimp tube, type KYNAR over the cable and place 20 mm of adhesive tape inside the end of the KYNAR crimp tube.
- b. Crimp the tube. Make sure that the glue flows properly out on the outer sheath of the cable. Crimp the tube down and pinch the end with flat bit pliers so that the glue is clearly visible.

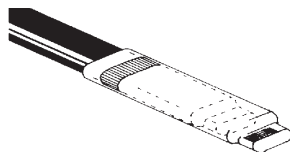

08090517

DEVI A/S

Ulvehavevej 61

DK-7100 Vejle

Tel: +45 7642 4700

Fax: +45 7642 4701

www.DEVI.com