

# HERO B

108704.01 + 108913.99

**novalux**  
ITALIAN LIGHTING DESIGN SINCE 1948

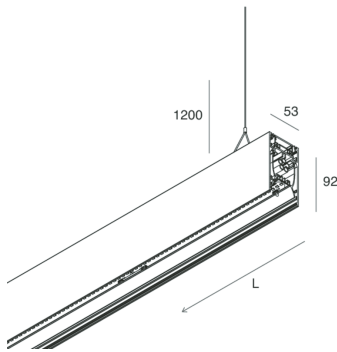
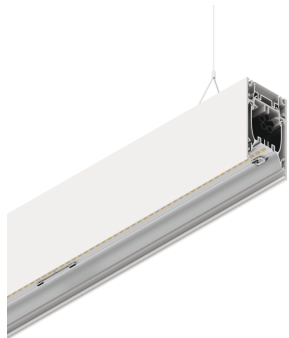

## Features

Use: Indoor  
Type of installation: SUSPENDED  
Emission: DIRECT/INDIRECT  
Optics: MICROPRISMATIZED  
Colour: WHITE  
Dimming: ON/OFF  
Emergency: NO  
L: 1960mm  
A: 53mm  
H: 92mm  
Made in: ITALY  
Warranty: 5 years  
Weight: 7kg

## Tech data

Luminaire input power: 88.8W  
Luminaire luminous flux: 7801lm  
Indirect luminous flux: 4151lm  
IP: 40  
Insulation class: I  
Supply voltage: 220-240V 50/60Hz  
UGR: <19  
SELV: Si

## Source

Light source: LED  
Source power: 79W  
Colour temperature: 2700K  
CRI: >90  
Colour tolerance: 3 Step MacAdam  
LED lifespan: 50000h L80 B20

## Compliance

CEI EN 60598-1:2021 + A11:2023, CEI EN 60598-2-1:2022

## Standards

Photobiological risk: RISK GROUP 0 Certified fixture in EXEMPT GROUP, in accordance with CEI EN 62471:2010-01, IEC TR 62778:2014.

CAM edilizia: The product complies with the requirements for public buildings, ministerial decree of 23rd June 2022 n.256.

## Average luminance

Average luminance limits for DSE workstation 65°(in accordance to EN 12464-1:2012).

[View more product info](#)



Novalux S.r.l. via Marzabotto, 2 40050 Funo di Argelato (BO) Italy  
Tel: +39 051 860558 · Fax +39 051 6647859 · Mail: info@novalux.it · VAT number 00536541204 · novalux.com  
Company subject to the management and coordination by SLV GmbH

This technical data sheet is owned by Novalux S.r.l., all rights reserved. Novalux S.r.l. reserves the right to make changes without prior notice.  
Last update: 21/3/2024, 17:32:09

# HERO B



108704.01 + 108913.99

**novalux**  
ITALIAN LIGHTING DESIGN SINCE 1948

## COMPLETION ACCESSORIES

	HERO B: MOD.CIECO ANG.DX 150 BIA	<b>1087A5.01</b>
	HERO B: MOD.CIECO 250 BIA	<b>1087A3.01</b>
	HERO B: MOD.CIECO 1680 BIA	<b>1087A8.01</b>
	HERO B: MOD.CIECO 1400 BIA	<b>1087A7.01</b>
	HERO B: MOD.CIECO ANG.SX 150 BIA	<b>1087A4.01</b>
	HERO B: COPPIA TESTATE BIA	<b>1087B1.01</b>
	HERO B: MOD.CIECO 1120 BIA	<b>1087A6.01</b>

## MOUNTING ACCESSORIES

	HERO B: KIT COPPIA CAVI SOSP. 5 M	<b>1087B2.99</b>
	KIT ALIMENTAZIONE L1200 3P BIA	<b>108919.01</b>
	KIT ALIMENTAZIONE L3000 3P BIA	<b>108920.01</b>



Novalux S.r.l. via Marzabotto, 2 40050 Funo di Argelato (BO) Italy  
Tel: +39 051 860558 · Fax +39 051 6647859 · Mail: info@novalux.it · VAT number 00536541204 · novalux.com  
Company subject to the management and coordination by SLV GmbH

This technical data sheet is owned by Novalux S.r.l., all rights reserved. Novalux S.r.l. reserves the right to make changes without prior notice.  
Last update: 21/3/2024, 17:32:09