

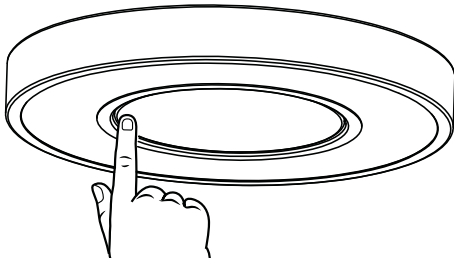

Circulus



230V, 50/60Hz, 17W, Class I, IP21

 <p>NO: Kan kun installeres av en registrert installasjonsvirksomhet EN: Only to be installed by an authorized electrician FR: Doit être installé par un électricien autorisé NL: Mag alleen geïnstalleerd worden door een bevoegde elektricien DE: Dieses Produkt darf nur durch autorisiertes Personal (z. B. Elektro-Installateur) angeschlossen und in Betrieb genommen werden.</p>	<p>1</p> 
<p>2</p>  <p>NO: Skru av strømmen før montering EN: Turn off power before installing FR: Couper le courant avant l'installation NL: Stroom uitschakelen voor u het toestel installeert DE: Vor Installationsarbeiten den Strom abschalten.</p>	
<p>3</p>  <p>0,5 - 1,0 mm² 8 mm 1,5 - 2,5 mm² 12 mm</p> <p>ca 10° (max. 20°) Max 16 A</p>	<p>4</p> 
<p>5</p> 	<p>6</p> 

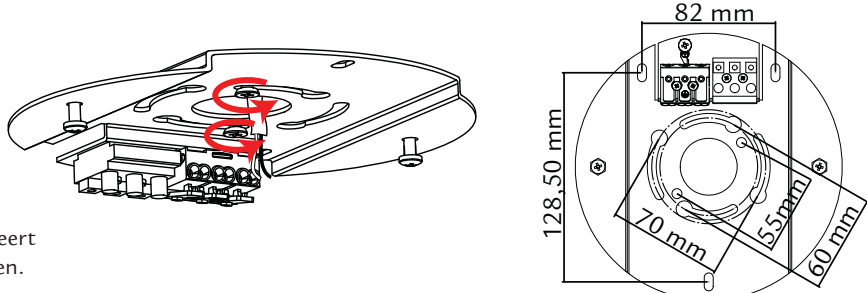
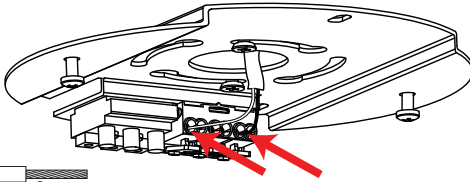
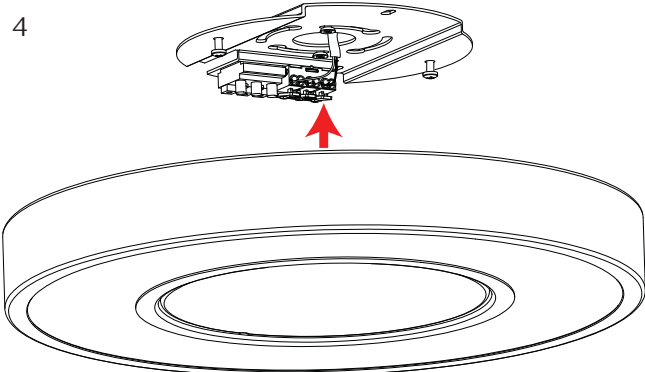
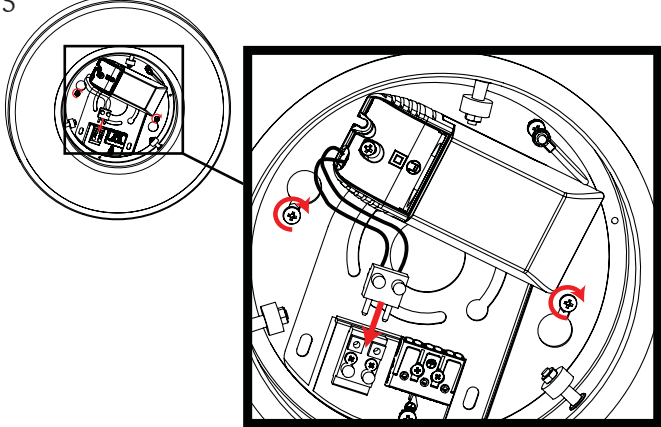
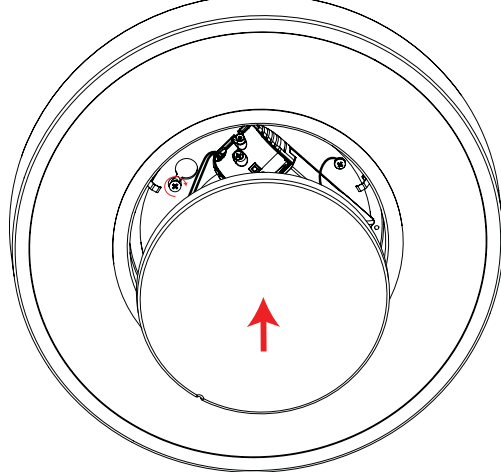
Rev: 27.06.2016

CORPORATE OFFICE:
SG Armaturen AS
 Svåbekk 15
 4790 Lillesand
 NORGE
 Tlf:+47 37 50 03 00
 firmapost@sg-as.no
 www.sg-as.no

BRANCH OFFICE:
 SG Lighting SA/NV
 Blokhuisstraat 47
 2800 Mechelen Noord I
 BELGIQUE/BELGIË
 Tlf:+32(0) 15 20 72 71
 info.benelux@sglighting.net
 www.sglighting.net

BRANCH OFFICE:
 SG Armaturen A/S
 Egebakken 19
 7400 Herning
 DANMARK
 Tlf:+45 70 70 72 13
 info@sg-as.dk
 www.sg-as.dk



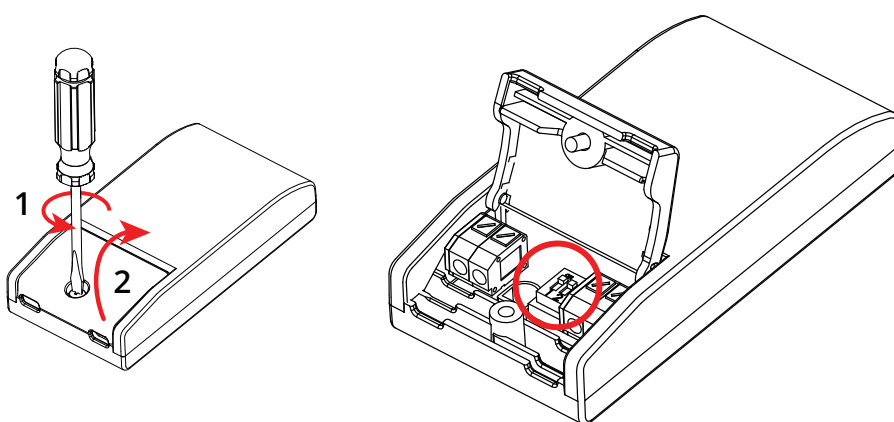

BRANCH OFFICE:
 SG Lighting SA/NV
 73 rue de Saint Mandrier
 83140 Six Fours Les Plages
 FRANCE
 Tlf:+33(0) 4 94 93 00 00
 info.france@sglighting.fr
 www.sglighting.net

BRANCH OFFICE:
 SG Leuchten GmbH
 Postfach 67 04 21
 22344 Hamburg
 GERMANY
 Tlf:+49 40 23 99 44 59
 info@sg-leuchten.de
 www.sg-leuchten.de

BRANCH OFFICE:
 SG Armaturen AB
 August Barksg. 30B
 421 32 Västra Frölunda
 SVERIGE
 Tlf:+46 31 81 71 10
 info@sg-ab.se
 www.sg-ab.se



(Standard)

				
mA	300	350	400	450
W	11	13	15	17
lm	65%	76%	88%	100%