



# WLD4FP-2216N130A00

W4

MINIATURE PHOTOELECTRIC SENSORS

**SICK**  
Sensor Intelligence.



Illustration may differ

### Ordering information

| Type               | Part no. |
|--------------------|----------|
| WLD4FP-2216N130A00 | 1119994  |

Other models and accessories → [www.sick.com/W4](http://www.sick.com/W4)



### Detailed technical data

#### Features

|  |   |
|--|---|
| <b>Functional principle</b>  | Photoelectric retro-reflective sensor                 |
| <b>Functional principle detail</b>   | With minimum distance to reflector (dual lens system) |
| <b>Sensing range</b>   |   |
| Sensing range min.   | 0 mm  |
| Sensing range max.   | 4.5 m   |
| Maximum distance range from reflector to sensor (operating reserve 1)        | 0.015 m ... 4.5 m                                     |
| Recommended distance range from reflector to sensor (operating reserve 3,75) | 0.035 m ... 3.9 m                                     |
| Reference reflector  | Reflector P250  |
| Recommended sensing range for the best performance                           | 0.035 m ... 3.9 m                                     |
| <b>Polarisation filters</b>  | Yes   |
| <b>Emitted beam</b>  |   |
| Light source   | PinPoint LED  |
| Type of light  | Visible red light                                     |
| Shape of light spot  | Point-shaped  |
| Light spot size (distance)   | Ø 38 mm (1,000 mm)                                    |

|   |  |
|---|--|
| Maximum dispersion of the emitted beam around the standardized transmission axis (squint angle) | < +/- 1.5° (at T <sub>a</sub> = +23 °C)  |
| <b>Key LED figures</b>  |  |
| Normative reference   | EN 62471:2008-09   IEC 62471:2006, modified  |
| LED risk group marking  | Free group   |
| Wave length   | 635 nm   |
| Average service life  | 100,000 h at T <sub>a</sub> = +25 °C   |
| <b>Adjustment</b>   |  |
| Teach-in button   | BluePilot: for sensitivity adjustment  |
| IO-Link   | For configuring the sensor parameters and Smart Task functions   |
| <b>Indication</b>   |  |
| LED blue  | BluePilot: Alignment aid   |
| LED green   | Operating indicator<br>Static on: power on<br>Flashing: IO-Link mode   |
| LED yellow  | Status of received light beam<br>Static on: object not present<br>Static off: object present<br>Flashing: Below the 1.5 function reserve |
| <b>Special features</b>   | Pin2 pre-setting (MF): not active  |

#### Safety-related parameters

|                                     |  |
|-------------------------------------|--|
| <b>MTTF<sub>D</sub></b>             | 747 years                                  |
| <b>DC<sub>avg</sub></b>             | 0 %  |
| <b>T<sub>M</sub> (mission time)</b> | 20 years (EN ISO 13849, rate of use: 60 %) |

#### Communication interface

|                             |  |
|-----------------------------|--|
| <b>IO-Link</b>              | ✓, IO-Link V1.1  |
| Data transmission rate      | COM2 (38,4 kBaud)  |
| Cycle time                  | 2.3 ms   |
| Process data length         | 16 Bit   |
| Process data structure      | Bit 0 = switching signal Q <sub>L1</sub><br>Bit 1 = switching signal Q <sub>L2</sub><br>Bit 2 ... 15 = Current receiver level (live) |
| VendorID                    | 26   |
| DeviceID HEX                | 0x8002BA   |
| DeviceID DEC                | 8389306  |
| Compatible master port type | A  |
| SIO mode support            | Yes  |

#### Electrical data

|                                     |                                   |
|-------------------------------------|-----------------------------------|
| <b>Supply voltage U<sub>B</sub></b> | 10 V DC ... 30 V DC <sup>1)</sup> |
| <b>Ripple</b>                       | ≤ 5 V <sub>pp</sub>               |

<sup>1)</sup> Limit values.

<sup>2)</sup> Signal transit time with resistive load in switching mode.

<sup>3)</sup> With light/dark ratio 1:1.

<sup>4)</sup> This switching output must not be connected to another output.

|                                       |  |
|---------------------------------------|--|
| <b>Usage category</b>                 | DC-12 (According to EN 60947-5-2)<br>DC-13 (According to EN 60947-5-2)                                       |
| <b>Current consumption</b>            | ≤ 20 mA, without load. At $U_B = 24\text{ V}$  |
| <b>Protection class</b>               | III  |
| <b>Digital output</b>                 |  |
| Number                                | 1  |
| Type                                  | Push-pull: PNP/NPN   |
| Signal voltage PNP HIGH/LOW           | Approx. $U_B - 2.5\text{ V} / 0\text{ V}$  |
| Signal voltage NPN HIGH/LOW           | Approx. $U_B / < 2.5\text{ V}$   |
| Output current $I_{\max.}$            | ≤ 100 mA   |
| Circuit protection outputs            | Reverse polarity protected<br>Overcurrent protected<br>Short-circuit protected                               |
| Response time                         | ≤ 500 $\mu\text{s}$  |
| Repeatability (response time)         | 150 $\mu\text{s}$ <sup>2)</sup>  |
| Switching frequency                   | 1,000 Hz <sup>3)</sup>   |
| <b>Pin/Wire assignment</b>            |  |
| Function of pin 4/black (BK)          | Digital output, light switching, object present → output $Q_{L1}$ LOW; IO-Link communication C <sup>4)</sup> |
| Function of pin 4/black (BK) – detail | The pin 4 function of the sensor can be configured, Additional possible settings via IO-Link                 |
| Function of pin 2/white (WH)          | Not active   |
| Function of pin 2/white (WH) – detail | The pin 2 function of the sensor can be configured, Additional possible settings via IO-Link                 |

<sup>1)</sup> Limit values.

<sup>2)</sup> Signal transit time with resistive load in switching mode.

<sup>3)</sup> With light/dark ratio 1:1.

<sup>4)</sup> This switching output must not be connected to another output.

## Mechanical data

|   |                           |
|---|---------------------------|
| <b>Housing</b>  | Rectangular               |
| <b>Design detail</b>                                  | Flat                      |
| <b>Dimensions (W x H x D)</b>                         | 16 mm x 40.1 mm x 12.1 mm |
| <b>Connection</b>                                     | Male connector M8, 4-pin  |
| <b>Material</b>                                       |                           |
| Housing   | Plastic, VISTAL®          |
| Front screen  | Plastic, PMMA             |
| Male connector  | Plastic, VISTAL®          |
| <b>Weight</b>   | Approx. 30 g              |
| <b>Maximum tightening torque of the fixing screws</b> | 0.4 Nm                    |

## Ambient data

|                                      |  |
|--------------------------------------|--|
| <b>Enclosure rating</b>              | IP66 (EN 60529)<br>IP67 (EN 60529)                     |
| <b>Ambient operating temperature</b> | -40 °C ... +60 °C                                      |
| <b>Ambient temperature, storage</b>  | -40 °C ... +75 °C                                      |
| <b>Typ. Ambient light immunity</b>   | Artificial light: ≤ 50,000 lx<br>Sunlight: ≤ 50,000 lx |

|  |   |
|--|---|
| <b>Shock resistance</b>                    | 30 g, 11 ms (3 positive and 3 negative shocks along X, Y, Z axes, 18 total shocks (EN60068-2-27)) |
| <b>Vibration resistance</b>                | 10 Hz ... 1,000 Hz (Amplitude 1 mm, 3 x 30 min (EN60068-2-6))                                     |
| <b>Air humidity</b>                        | 35 % ... 95 %, Relative humidity (no condensation)  |
| <b>Electromagnetic compatibility (EMC)</b> | EN 60947-5-2  |
| <b>Resistance to cleaning agent</b>        | ECOLAB  |
| <b>UL File No.</b>                         | NRKH.E181493 & NRKH7.E181493  |

### Smart Task

|                                  |  |
|----------------------------------|--|
| <b>Smart Task name</b>           | Base logics  |
| <b>Logic function</b>            | Direct<br>AND<br>OR  |
| <b>Timer function</b>            | Deactivated<br>On delay<br>Off delay<br>ON and OFF delay<br>Impulse (one shot) |
| <b>Inverter</b>                  | Yes  |
| <b>Switching frequency</b>       | SIO Logic: 800 Hz <sup>1)</sup><br>IOL: 750 Hz <sup>2)</sup>                   |
| <b>Response time</b>             | SIO Logic: 600 μs <sup>1)</sup><br>IOL: 650 μs <sup>2)</sup>                   |
| <b>Repeatability</b>             | SIO Logic: 200 μs <sup>1)</sup><br>IOL: 250 μs <sup>2)</sup>                   |
| <b>Switching signal</b>          |  |
| Switching signal Q <sub>L1</sub> | Switching output   |
| Switching signal $\bar{Q}_{L1}$  | Switching output   |

<sup>1)</sup> Use of Smart Task functions without IO-Link communication (SIO mode).

<sup>2)</sup> Use of Smart Task functions with IO-Link communication function.

### Diagnosis

|  |                                      |
|--|--------------------------------------|
| <b>Device temperature</b>                          |                                      |
| Measuring range                                    | Very cold, cold, moderate, warm, hot |
| <b>Device status</b>                               | Yes                                  |
| <b>Detailed device status</b>                      | Yes                                  |
| <b>Operating hour counter</b>                      | Yes                                  |
| <b>Operating hours counter with reset function</b> | Yes                                  |
| <b>Quality of teach</b>                            | Yes                                  |
| <b>Quality of run</b>                              | Yes, Contamination display           |

### Classifications

|                     |          |
|---------------------|----------|
| <b>ECLASS 5.0</b>   | 27270902 |
| <b>ECLASS 5.1.4</b> | 27270902 |
| <b>ECLASS 6.0</b>   | 27270902 |
| <b>ECLASS 6.2</b>   | 27270902 |
| <b>ECLASS 7.0</b>   | 27270902 |

|                       |          |
|-----------------------|----------|
| <b>ECLASS 8.0</b>     | 27270902 |
| <b>ECLASS 8.1</b>     | 27270902 |
| <b>ECLASS 9.0</b>     | 27270902 |
| <b>ECLASS 10.0</b>    | 27270902 |
| <b>ECLASS 11.0</b>    | 27270902 |
| <b>ECLASS 12.0</b>    | 27270904 |
| <b>ETIM 5.0</b>       | EC002717 |
| <b>ETIM 6.0</b>       | EC002717 |
| <b>ETIM 7.0</b>       | EC002717 |
| <b>ETIM 8.0</b>       | EC002717 |
| <b>UNSPSC 16.0901</b> | 39121528 |

## Adjustments

Display and adjustment elements

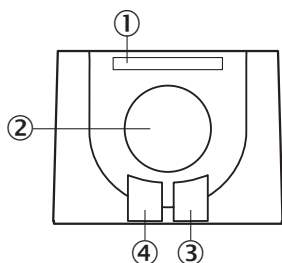

- ① LED blue
- ② Teach-in button
- ③ LED yellow
- ④ LED green

## Connection type

Male connector M8, 4-pin

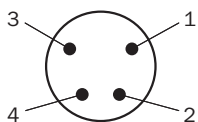

## Connection diagram

Cd-390

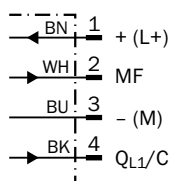

Truth table

Push-pull: PNP/NPN - light switching Q

|                         | Light switching Q (normally closed (upper switch), normally open (lower switch)) |                             |
|-------------------------|--|-----------------------------|
|                         | Object not present → Output HIGH   | Object present → Output LOW |
| Light receive           | ✓  | ✗                           |
| Light receive indicator | ☉  | ✗                           |
| Load resistance to L+   | ✗  | ⚠                           |
| Load resistance to M    | ⚠  | ✗                           |
|                         |  |                             |

Push-pull: PNP/NPN – dark switching  $\bar{Q}$

|                         | Dark switching $\bar{Q}$ (normally open (upper switch), normally closed (lower switch)) |                              |
|-------------------------|---|------------------------------|
|                         | Object not present → Output LOW   | Object present → Output HIGH |
| Light receive           | ✓   | ✗                            |
| Light receive indicator | ☉   | ✗                            |
| Load resistance to L+   | ⚠   | ✗                            |
| Load resistance to M    | ✗   | ⚠                            |
|                         |   |                              |

### Characteristic curve

Reflective tape

Operating reserve



Recommended sensing range for the best performance

- ① Reflective tape REF-DG
- ② Reflective tape REF-IRF-56
- ③ Reflective tape REF-AC1000



Standard reflectors

Operating reserve

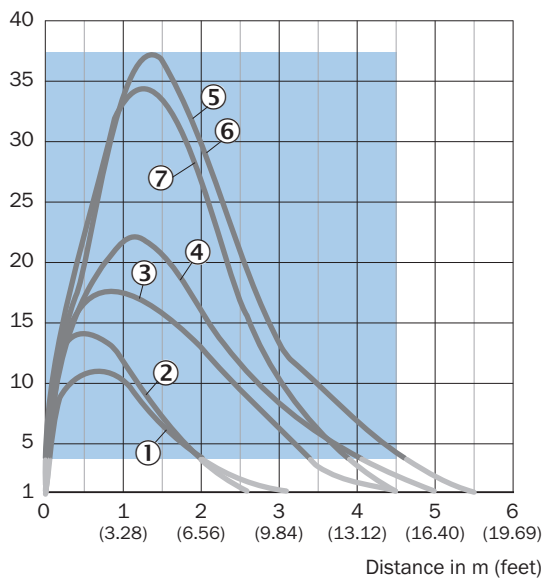

Recommended sensing range for the best performance

- ① Reflector PL22
- ② Reflector PL20A
- ③ Reflector PL30A
- ④ Reflector PL40A
- ⑤ Reflector PL80A
- ⑥ Reflector C110A
- ⑦ Reflector P250

Fine triple reflectors

Operating reserve

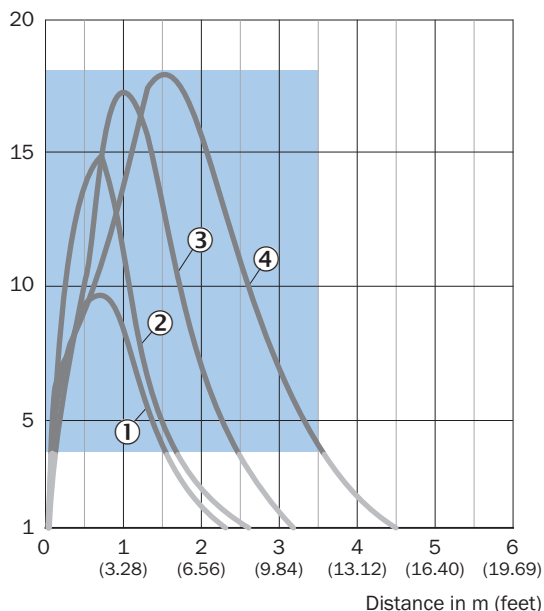

- Recommended sensing range for the best performance
- ① PL10FH reflector
- ② PL10F reflector
- ③ Reflector PL20F
- ④ Reflector P250F

Chemical-resistant reflectors

Operating reserve

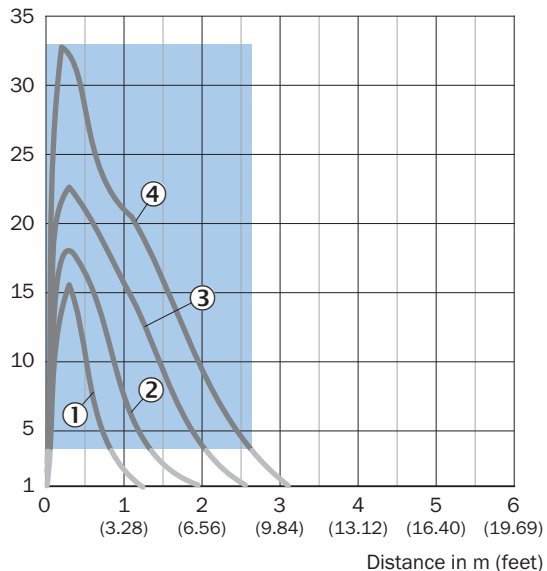

- Recommended sensing range for the best performance
- ① PL10F CHEM reflector
- ② Reflector PL20 CHEM
- ③ Reflector P250 CHEM
- ④ Reflector P250H

## Light spot size

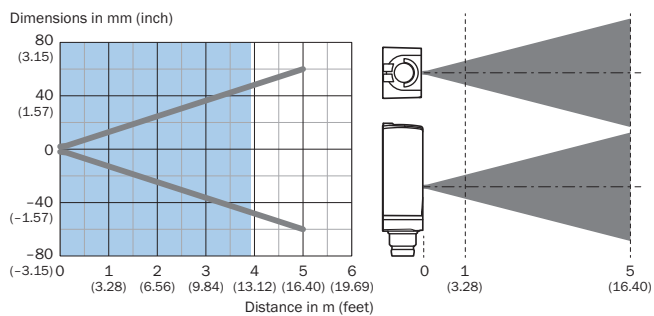

Recommended sensing range for the best performance

## Sensing range diagram

### Standard reflectors

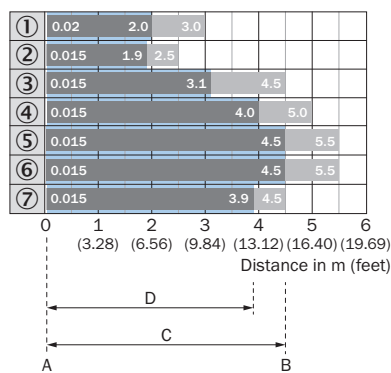

A = Sensing range min. in m

B = Sensing range max. in m

C = Maximum distance range from reflector to sensor (operating reserve 1)

D = Recommended distance range from reflector to sensor (operating reserve 3.75)

Recommended sensing range for the best performance

- ① Reflector PL22
- ② Reflector PL20A
- ③ Reflector PL30A
- ④ Reflector PL40A
- ⑤ Reflector PL80A
- ⑥ Reflector C110A
- ⑦ Reflector P250

### Reflective tape



A = Sensing range min. in m  
 B = Sensing range max. in m  
 C = Maximum distance range from reflector to sensor (operating reserve 1)  
 D = Recommended distance range from reflector to sensor (operating reserve 3.75)

Recommended sensing range for the best performance

- ① Reflective tape REF-DG (50 x 50 mm)
- ② Reflective tape REF-IRF-56
- ③ Reflective tape REF-AC1000

### Fine triple reflectors



A = Sensing range min. in m  
 B = Sensing range max. in m  
 C = Maximum distance range from reflector to sensor (operating reserve 1)  
 D = Recommended distance range from reflector to sensor (operating reserve 3.75)

Recommended sensing range for the best performance

- ① PL10FH reflector
- ② PL10F reflector
- ③ Reflector PL20F
- ④ Reflector P250F

### Chemical-resistant reflectors



A = Sensing range min. in m  
 B = Sensing range max. in m  
 C = Maximum distance range from reflector to sensor (operating reserve 1)  
 D = Recommended distance range from reflector to sensor (operating reserve 3.75)

Recommended sensing range for the best performance

- ① PL10F CHEM reflector
- ② Reflector PL20 CHEM
- ③ Reflector P250 CHEM
- ④ Reflector P250H

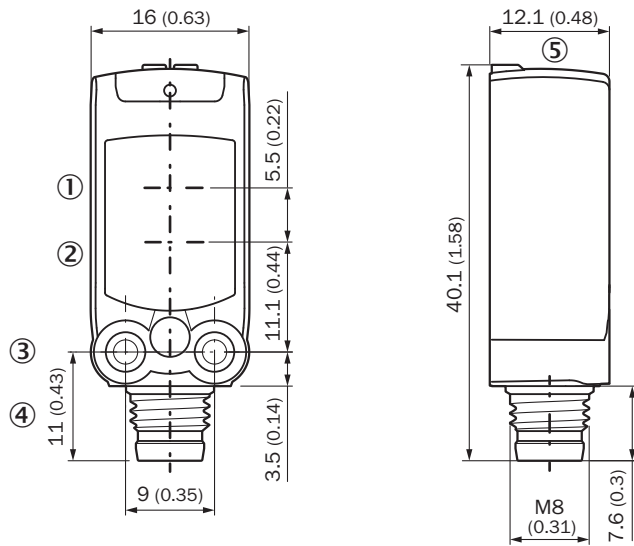

**Dimensional drawing** (Dimensions in mm (inch))



- ① Center of optical axis, sender
- ② Center of optical axis, receiver
- ③ M3 mounting hole
- ④ Connection
- ⑤ Display and adjustment elements

**Recommended accessories**

Other models and accessories → [www.sick.com/W4](http://www.sick.com/W4)

|   | Brief description   | Type       | Part no. |
|---|---|------------|----------|
| <b>Mounting brackets and plates</b>   |   |            |          |
|  | Mounting bracket for wall mounting, Stainless steel 1.4571, mounting hardware included  | BEF-W4-A   | 2051628  |
| <b>Plug connectors and cables</b>   |   |            |          |
|  | <ul style="list-style-type: none"> <li>• <b>Connection type head A:</b> Male connector, M8, 4-pin, straight</li> <li>• <b>Description:</b> Unshielded</li> <li>• <b>Connection systems:</b> Screw-type terminals</li> <li>• <b>Permitted cross-section:</b> 0.14 mm<sup>2</sup> ... 0.5 mm<sup>2</sup></li> </ul> | STE-0804-G | 6037323  |
| <b>Reflectors</b>   |   |            |          |
|  | Fine triple reflector, screw connection, suitable for laser sensors, 20 mm x 32 mm, PM-MA/ABS, Screw-on, 2 hole mounting  | PL10F      | 5311210  |

## SICK AT A GLANCE

SICK is one of the leading manufacturers of intelligent sensors and sensor solutions for industrial applications. A unique range of products and services creates the perfect basis for controlling processes securely and efficiently, protecting individuals from accidents and preventing damage to the environment.

We have extensive experience in a wide range of industries and understand their processes and requirements. With intelligent sensors, we can deliver exactly what our customers need. In application centers in Europe, Asia and North America, system solutions are tested and optimized in accordance with customer specifications. All this makes us a reliable supplier and development partner.

Comprehensive services complete our offering: SICK LifeTime Services provide support throughout the machine life cycle and ensure safety and productivity.

For us, that is “Sensor Intelligence.”

## WORLDWIDE PRESENCE:

Contacts and other locations –[www.sick.com](http://www.sick.com)