



Product designation

Changeover
contactor
assemblies
BFC

Product type designation

Electrical features

Maximum operating current ($\leq 440V$)

A 165

Contact characteristics

Operational current Ie

AC-1 ($\leq 40^{\circ}C$)	A	165
AC-1 ($\leq 55^{\circ}C$)	A	135
AC-1 ($\leq 60^{\circ}C$)	A	118

Mechanical features

Terminals type

Screw

Fixing

Side mount

Weight

g 4892

Dimensions

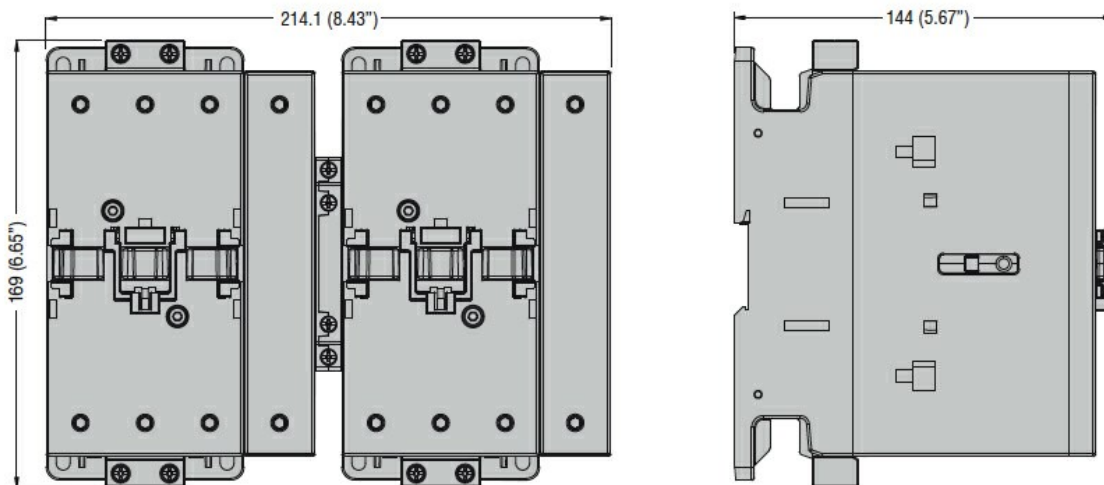

Wiring diagrams

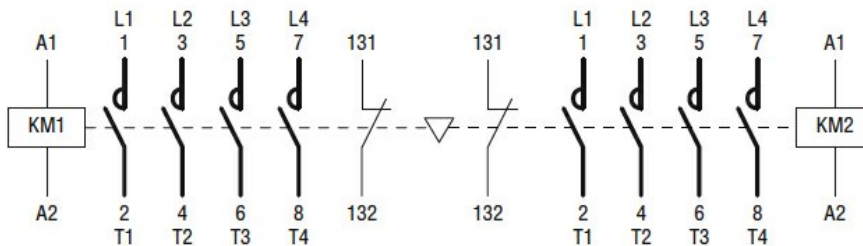

ETIM classification

ETIM 8.0

EC00010 -
Combination of
contactors