



PM3S96-00230060

Mirror columns with separate mirrors

COLUMNS FOR SAFETY MULTIBEAM SENSORS

SICK
Sensor Intelligence.

PM3S96-00230060 | Mirror columns with separate mirrors

COLUMNS FOR SAFETY MULTIBEAM SENSORS



Ordering information

Type	Part no.
PM3S96-00230060	1040620

Other models and accessories → www.sick.com/Mirror_columns_with_separate_mirrors

Detailed technical data

Features

Model	Mirror columns with adjustable individual mirrors
Suitable for	Safety multibeam sensors
Suitable for number of beams	2
Suitable for beam separation	600 mm
Type of diversion	Horizontal

Mechanical data

Number of mirrors	2
Mirror length	90 mm
Mirror width	100 mm
Column height	985 mm
Height of first beam above ground	300 mm
Dimensional drawing	L1 300 mm L2 600 mm L5 985 mm
Weight	6,300 g

Classifications

ECLASS 5.0	27279203
ECLASS 5.1.4	27279203
ECLASS 6.0	27279203
ECLASS 6.2	27279203
ECLASS 7.0	27279203
ECLASS 8.0	27279203
ECLASS 8.1	27279203
ECLASS 9.0	27273601
ECLASS 10.0	27273601
ECLASS 11.0	27273601

ECLASS 12.0	27273601
ETIM 5.0	EC002467
ETIM 6.0	EC002467
ETIM 7.0	EC002467
ETIM 8.0	EC002467
UNSPSC 16.0901	39111609

Dimensional drawing (Dimensions in mm (inch))

For horizontal beam deflection. Note the reduced scanning range!

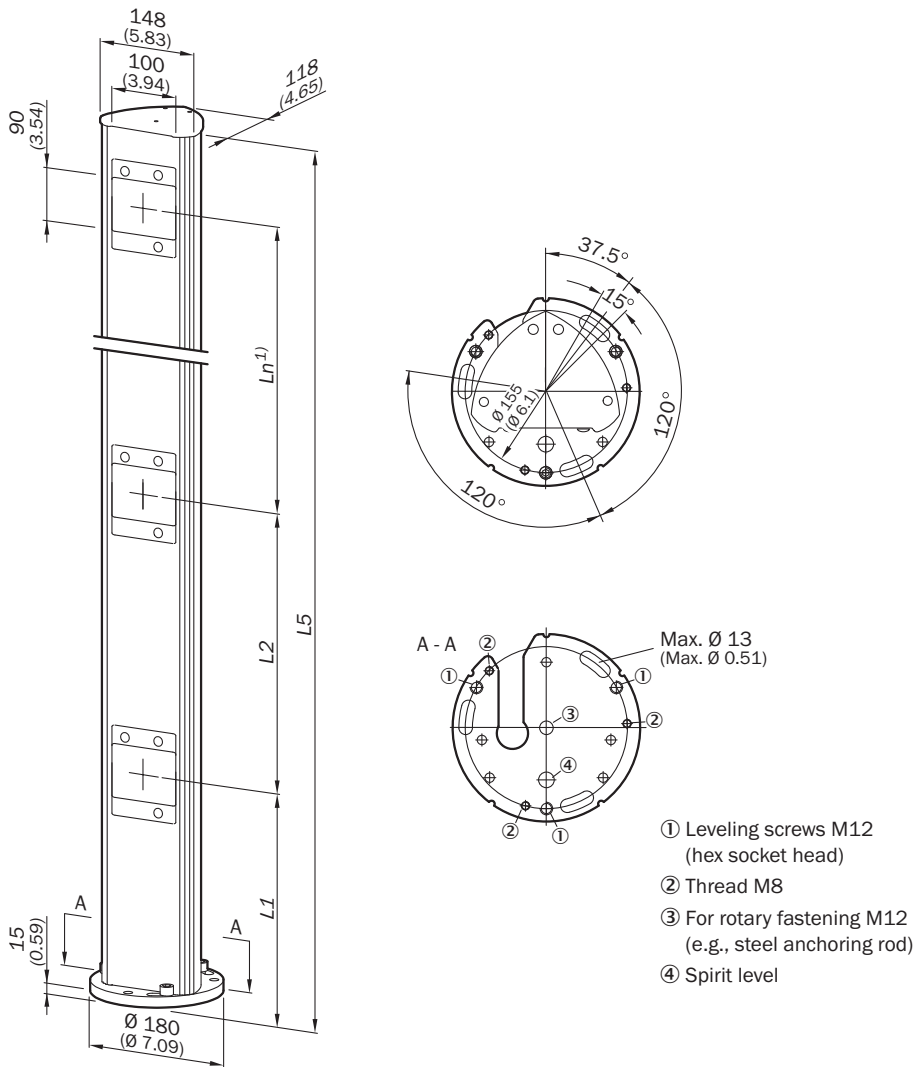

- ① Leveling screws M12 (hex socket head)
- ② Thread M8
- ③ For rotary fastening M12 (e.g., steel anchoring rod)
- ④ Spirit level

	L1	L2	L3	L4	L5	
2	400	500	-	-	985	1040619
2	300	600	-	-	985	1040620
3	300	400	400	-	1,185	1040625
3	300	450	450	-	1,285	1040624
4	300	300	300	300	1,285	1040626

SICK AT A GLANCE

SICK is one of the leading manufacturers of intelligent sensors and sensor solutions for industrial applications. A unique range of products and services creates the perfect basis for controlling processes securely and efficiently, protecting individuals from accidents and preventing damage to the environment.

We have extensive experience in a wide range of industries and understand their processes and requirements. With intelligent sensors, we can deliver exactly what our customers need. In application centers in Europe, Asia and North America, system solutions are tested and optimized in accordance with customer specifications. All this makes us a reliable supplier and development partner.

Comprehensive services complete our offering: SICK LifeTime Services provide support throughout the machine life cycle and ensure safety and productivity.

For us, that is “Sensor Intelligence.”

WORLDWIDE PRESENCE:

Contacts and other locations –www.sick.com