

C5S11

Ventouse électromagnétique applique 500 Kg (usage général hors sécurité incendie)

FR

PRÉSENTATION DU PRODUIT

- **Signal**
- **Applique**
- **Livrée avec contre-plaque**
- **Résistance à la corrosion pas d'usure mécanique**
- **Facilité d'installation préconisée en intérieur**
- **Sécurité positive (libère instantanément l'accès en cas de coupure de courant)**
- **Force de rétention : 500 kg**
- **Pas de magnétisme résiduel**
- **Varistance incorporée : protection électronique intégrée contre l'effet de self**
- **Garantie 10 ans**

- Dimensions (L x l x P) : 266 x 66 x 40 mm
- Dimensions contre-plaque (L x l x P) : 185 x 60 x 12 mm
- Alimentation : 12/24 V DC
- Consommation :
 - 12 V DC = 550 mA
 - 24 V DC = 275 mA

MONTAGE

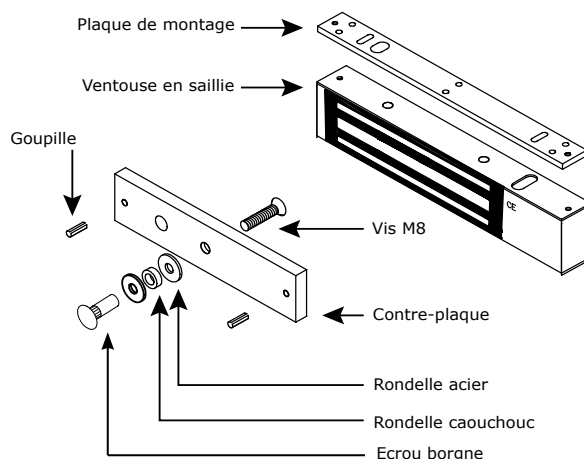

ÉLÉMENTS FOURNIS

Ventouse saillie	Contre-plaque	Plaque de montage	Goupille 5x16	Rondelle acier	Rondelle caoutchouc	Vis bois 4x25	Vis M8x25	Écrou borgne	Notice
1	1	1	2	2	1	8	1	1	1

- DÈEE et RoHS
- IP42
- Certification CE

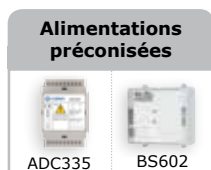

RACCORDEMENT

Réglage usine 12 V DC

Bornier	Correspondance
+	12 ou 24 V DC
-	0 V
N.C	NC (Normalement fermé)
COM	COM
N.O	NO (Normalement ouvert)

Le signal NO/NC ne commute que lorsque la porte fermée et sous tension.

NOTE IMPORTANTE

- Vérifier la position du cavalier avant de brancher la ventouse au courant d'entrée. Une position incorrecte peut endommager la ventouse. Ce type de dommage n'est pas couvert par la garantie.
- La ventouse et la contre-plaque doivent être impérativement alignés.

La contre-plaque doit être montée "flottante" autour de la vis centrale de montage pour compenser un mauvais alignement de la porte.

AVEC CARTE ÉLECTRONIQUE

Cavaliers de sélection de tension

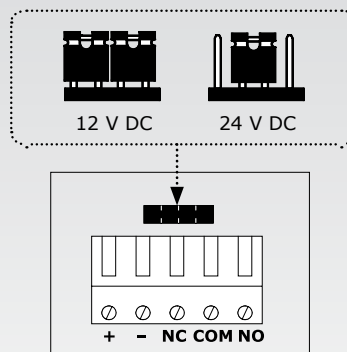

Pour assurer la conformité NFS 61-937 :

- alimenter la ventouse en 24V continu uniquement
- l'utilisation des contacts de position n'est pas admise
- se reporter à la notice "usage en système de sécurité incendie"

G0301FR0363V05

C5S11

500Kg Surface Mount Electromagnetic lock (for general use - not fire safety use)

EN

PRODUCT PRESENTATION

- **Monitored.**
- **Surface mount.**
- **Delivered with armature plate.**
- **Corrosion resistance.**
- **No mechanical wear.**
- **Ease of installation.**
- **Recommended for interior use.**
- **Fail safe (Door unlocked when power off).**
- **Holding force: 500kg.**
- **No residual magnetism.**
- **Built-in varistor : Built-in electronic protection to eliminate back EMF.**
- **10 year warranty**

- Dimensions (L x W x D): 266 x 66 x 40 mm.
- Armature dimensions (L x W x D): 185 x 60 x 12 mm.
- Power supply: 12/24V dc.
- Power absorption:
 - 12 V DC = 550mA,
 - 24 V DC = 275mA.

DEEE et RoHS

IP42

Certification CE

Recommended power supplies



INSTALLATION

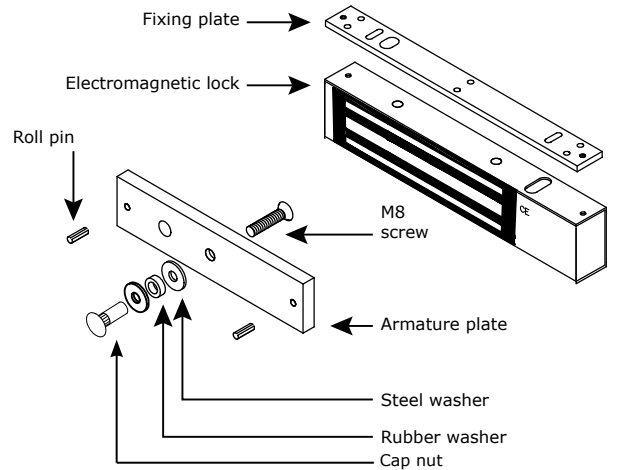

MOUNTING KIT

Magnetic locks	Armature plate	Fixing plate	Roll pin 5x16	Steel washer	Rubber washer	Mounting Screw 4x25	Screw M8x25	Cap nut	Manual
1	1	1	2	2	1	8	1	1	1

ELECTRICAL CONNECTIONS

12V dc Default setup

Terminal block	Correspondence
+	12 or 24V dc
-	- 0 V
N.C	NC (Normally closed)
COM	COM
N.O	NO (Normally open)

The NO/NC signal only switches when the door is closed with the power to it on.

IMPORTANT NOTE

- Check the jumper position before connecting the lock to the input current. A wrong position could damage the lock. This type of damage is not covered by the warranty.
- Make sure that the magnet and the armature meet evenly over their entire mating surfaces.

The Armature plate must be able to pivot slightly about its center mounting screw to compensate for any door misalignment.

WITH BUILT-IN PCB BOARD

Voltage selection jumpers

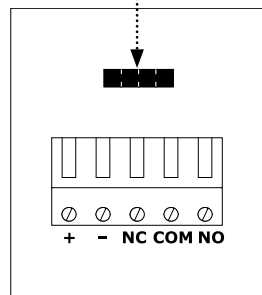
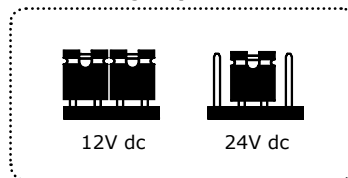

DIRECT CONNECTION

12V DC

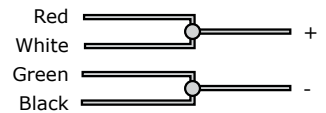

24V DC

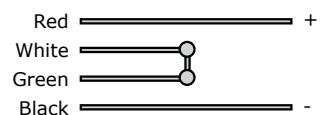

CONTACT

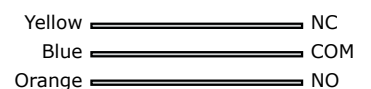

G0301FR0363V05

All the informations contained within this document (photos, features, specifications and dimensions) could be perceptibly different and can be changed without prior notice - cdvi.com