

2 analogue outputs module for 4 120 53

Cat. N°: 4 120 60



Contents	Pages
1. Description - Use.....	1
2. Range.....	1
3. Overall dimensions.....	1
4. Preparation - Connection.....	1
5. General characteristics.....	2
6. Compliance and approvals.....	2

1. DESCRIPTION - USE

2 analogue outputs module.

Allows the remote repetition, via analogue signal $0 \div 20$ mA et/or $4 \div 20$ mA of two electrical quantities.

2. RANGE

- . Cat. N° 4 120 60: 2 analogue outputs module, $0/4 \div 20$ mA; associable only to multifunction measuring device 4 120 53.
- . It is possible to connect a maximum of two modules 4 120 60 obtaining four analogue outputs.

Auxiliary supply:

- . Supplied by the multifunction measuring device 4 120 53

3. OVERALL DIMENSIONS

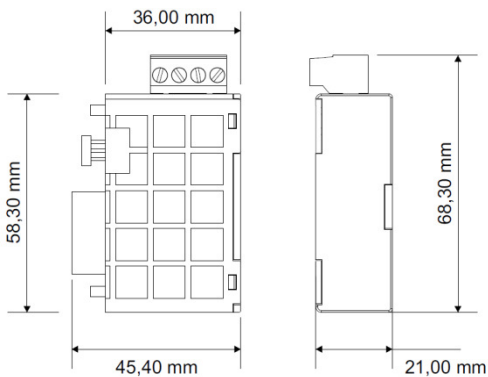

4. FIXING - CONNECTION

Fixing:

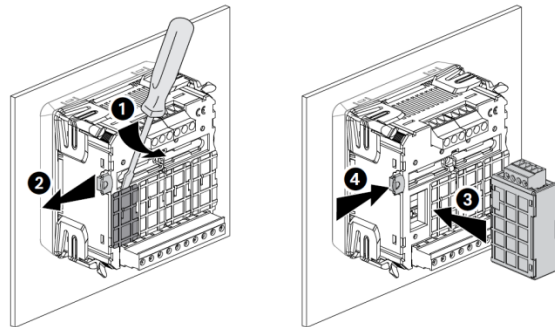

Note: modules must be connected with the device 4 120 53 not supplied.

Associability table:

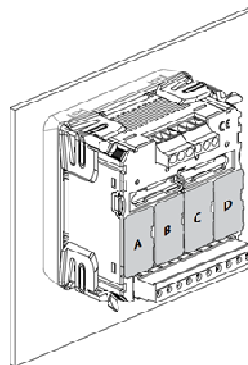

	A	B	C	D	
4 120 55	✓	x	x	x	max. 1
4 120 56	✓	x	x	x	max. 1
4 120 57	x	x	✓	✓	max. 2
4 120 58	x	x	x	✓	max. 1
4 120 59	✓	✓	✓	✓	max. 2
4 120 60	x	x	✓	✓	max. 2
4 120 61	x	✓	x	x	max. 1

Operating position:

- . Vertical Horizontal Upside down On the side

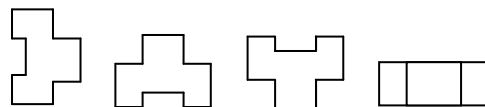

4. FIXING - CONNECTION *(continued)*

Screw terminals:

- . Terminal depth: 8 mm.
- . Stripping length: 8 mm

Screw head:

- . Screw slotted.

Recommended tightening torque:

- . 0,6 Nm.

Tools required:

- . For terminals: flat screwdriver 3,5 mm
- . For fixing the modules to the measuring device: flat screwdriver max. 5 mm.

Connectable section:

- . Copper cables.

	Without ferrule	With ferrule
Rigid cable	0,05 to 4,5 mm²	-
Flexible cable	0,05 to 2,5 mm²	0,05 to 2,5 mm²

Wiring diagrams:

- . Terminals identifications

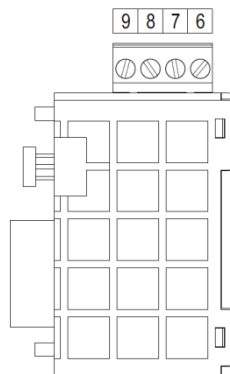

- . Wirings

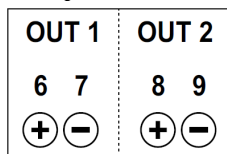

5. GENERAL CHARACTERISTICS

Terminals marking:

- . By permanent ink pad printing.

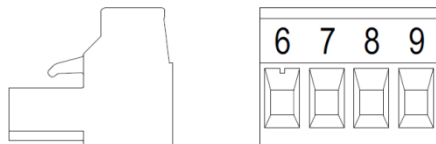

5. GENERAL CHARACTERISTICS *(continued)*

Variables associable to the analogue output:

- . Phase voltages, V1N, V2N, V3N
- . Chained voltages, U12, U23, U31
- . Phase currents, I1, I2, I3
- . Current - average value
- . Frequency, f
- . Three-phase active power (positive or negative), P
- . Phase active powers (positive or negative), P1, P2, P3
- . Three-phase reactive power (positive or negative), Q
- . Phase reactive powers (positive or negative), Q1, Q2, Q3
- . Active power - average value
- . Reactive power - average value
- . Lagging (PFL) or capacitive (PFC) power factor
- . Temperature (T1, T2) from external probe (with module 4 120 58)

Analogue output's characteristics:

- . Type: unidirectional at real or figurative zero for variable output load
- . Rated values: 0÷20 mA or 4÷20 mA
- . Response time: ≤ 600 ms
- . Output load: ≤ 750 Ω

Accuracy class:

- . cl: 0,5

Plastic material:

- . Self-extinguishing polycarbonate.

Ambient operating temperature:

- . Min. = - 5 °C Max. = + 55 °C.

Ambient storage temperature:

- . Min. = - 25 °C Max. = + 70 °C.

Impulse withstand voltage:

- . Supply / Out 1 - Out 2:
alternate current 50 Hz / 1 min.: 2 kV
- . Measuring inputs / Out 1 - Out 2:
alternate current 50 Hz / 1 min.: 2 kV

- Note:** values referred to combination measuring device + add-on module.

Average weight per device:

- . 0,040 kg.

Volume when packed:

- . 0,30 dm³

Consumption:

- . Module 4 120 60: ≤ 2 VA
- . Measuring device 4 120 53 + 1 Module 4 120 60: ≤ 6 VA
- . Measuring device 4 120 53 + 2 Modules 4 120 60: ≤ 8 VA

6. COMPLIANCE AND APPROVALS

Compliance to standards:

- . Compliance with Directive on electromagnetic compatibility (EMC) n° 2004/108/EC
- . Compliance with low voltage directive no. 73/23/CEE dated 19 February 1973, modified by directive no. 93/68/CEE dated 22 July 1993, modified by directive n° 2006/95/CE.