

# EasyLogic™ Sensors

## Temperature Sensors – Analog



### Product Description

The EasyLogic Living Space sensor is a cost-effective solution to measure, control and communicate temperature information. Designed for hassle-free installation, these sensors can be connected with Schneider Electric BAS controllers or other third-party systems. Available in two user interface options - a blank format for simple functionality or an LCD model with setpoint control.

### Features

- Cost-effective, temperature-only Living Space sensor
- Small form factor, basic housing, simple functionality
- Connects to SpaceLogic and EasyLogic controllers via analog inputs
- Easy to install and wire
- Surface mount, no limitations on wall box
- Blank cover model suitable for third-party controllers and systems

### Available Products

Model Number	Description
SLEASXXXB	Sensor, Blank Cover, Resistive, 10K T3, Wt
SLEASLXXB	Sensor, Solid State, Push-Button, LCD, Wt

### Specifications

Operating Environment	
Input power*	24 Vac / Vdc (±15%), 50 to 60 Hz
Analog output*	0 to 10 V
Operating temp. range	0 to 50 °C
Operating humidity range	5 to 95% RH non-condensing
Power consumption	< 1.2 W
Housing material	PC
IP rating	IP 20
Temperature Sensor	
Sensor type	Blank model: NTC 10k Type 3 LCD model: Solid state
Accuracy	±0.5 °C typical
Resolution	0.1 °C
Range	0 to 50 °C
Display Models	
LCD*	55.4 mm (2.18 in), segmented with two buttons Lockout override: Button lockout
Setpoints	
Temperature setpoint	0 to 10V output Scale: 5 to 30 °C (in 0.5 °C increments) Default setpoint value: 18 °C
Wiring Terminals	
Terminal blocks	18-24 AWG (0.75 to 0.25 mm <sup>2</sup> )
Screw terminal torque	0.3 N-m (2.0 in-lbF) max.
Regulatory Information	
Agency approvals	European conformance CE: IEC/EN 60730-1 IEC/EN 60730-2-9 RoHS, REACH, Green Premium

\*Display model only.

USA: +1 888-444-1311  
Europe: +46 10 478 2000  
Asia: +65 6484 7877  
www.schneider-electric.com

Life Is On

Schneider  
Electric

## Safety Information

### Important Information

Read these instructions carefully and look at the equipment to become familiar with the device before trying to install, operate, service or maintain it. The following special message may appear throughout this bulletin or on the equipment to warn of potential hazards or to call attention to information that clarifies or simplifies a procedure.

#### NOTICE

NOTICE is used to address practices not related to physical injury.

### Please Note

Electrical equipment should be installed, operated, serviced and maintained only by qualified personnel. No responsibility is assumed by Schneider Electric for any consequences arising out of the use of this material.

A qualified person is one who has the skills and knowledge related to the construction, installation and operation of electrical equipment and has received safety training to recognize and avoid the hazards involved.

### Dimensions mm (in.) SLEASLXXB

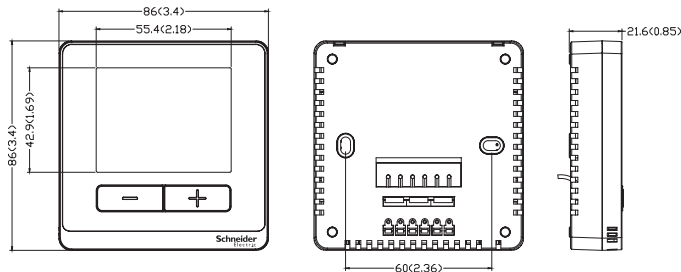

### SLEASXXXB

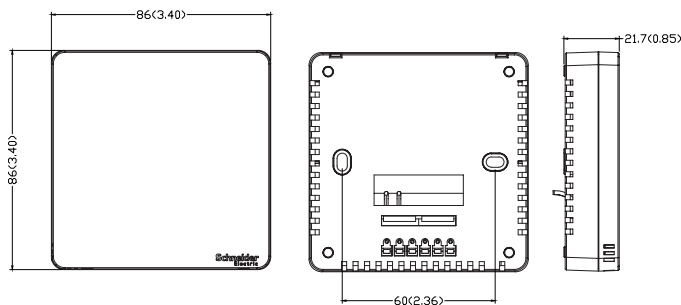

## Installation

### NOTICE

#### IMPROPER INSTALLATION

- Do not install on an exterior wall.
- Do not install behind a door.
- Do not install in areas with a direct heat source.
- Do not install near any air discharge grill.
- Do not install in areas exposed to direct sunlight.
- Ensure sensor has sufficient natural air circulation.
- Ensure wall surface is flat and clean.
- Install 1.3 to 1.5 m (52 to 60 in.) above the floor.
- Perform preventative maintenance on the damper and Variable Air Volume (VAV) box, according to supplier documentation.

**Failure to follow these instructions can result in equipment damage.**

1. Insert a 3.5 mm flat head screwdriver along the bevel into the slot. Pry upwards with appropriate force to release the two hooks.

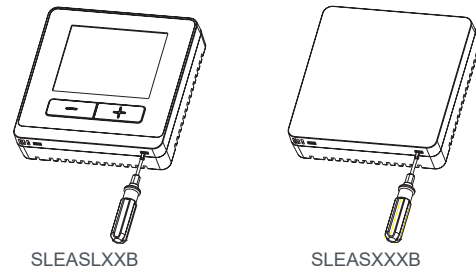

2. Remove the display from the base module. Carefully remove the wire connections, if required.

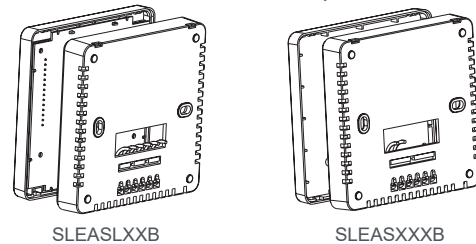

3. Connect the wires according to the appropriate wiring diagram shown below. Ensure the polarity of the mains supply is correct.

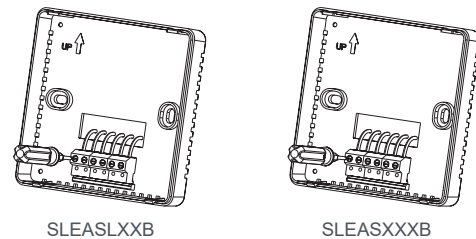

### Installation (cont.)

4. Mount the base module onto the wall box using the two screws supplied.

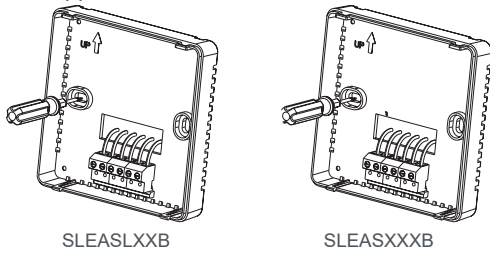

5. Fit the display module onto the base module. Align upper hooks between the two modules. Carefully replace the wiring connection if it has been removed. Click display module onto base module using the two lower hooks.

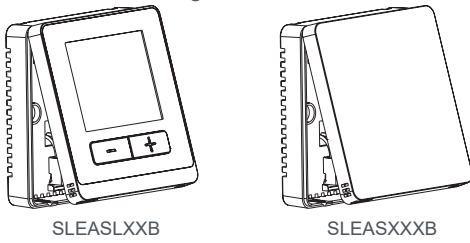

### Wiring SLEASLXXB

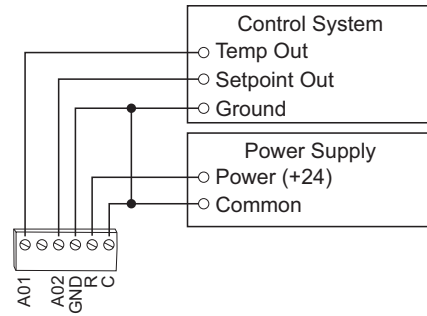

### SLEASXXXB

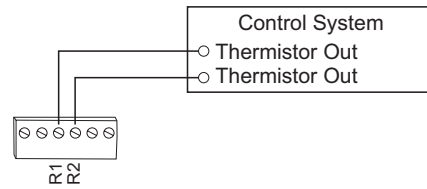

### Thermistor Table

°C	°F	Resistance (Ω)
0	32	29,465
10	50	18,754
20	68	11,272
25	77	10,000
30	86	8,232
40	104	5,643
50	122	3,944

## LCD Display Operation

### Button Functions

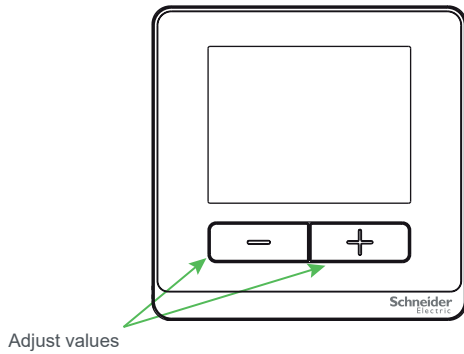

### Display Icons

The main screen displays the room temperature or temperature setpoint.



Room Temperature Screen



Temperature Setpoint Screen

### Setpoint Function

A single 0-10V temperature setpoint.

### Temperature Setpoint Adjustment

Press the Up Arrow button or Down Arrow button to enter the Setpoint Menu screen.



Adjusts setpoint down



Adjusts setpoint up



After adjustment, wait 6 seconds. Setpoint is accepted and main screen appears.

Note: To lock the temperature setpoint, press and hold the Up Arrow and Down Arrow buttons simultaneously for 6 seconds while the device is in Normal mode. Press and hold the two buttons again to exit the locking function.

## China RoHS Compliance Information

### Environment-Friendly Use Period (EFUP) Table

部件名称 Part name	有害物质/Hazardous substance					
	铅(Pb)	汞(Hg)	镉(Cd)	六价铬 (Cr(VI))	多溴联苯 (PBB)	多溴二苯醚 (PBDE)
金属/Metal	X	O	O	O	O	O
塑胶/Plastic	O	O	O	O	O	O
电子元器件/Electronics	X	O	O	O	O	O

本表格依据SJ/T11364的规定编制。

O: 表示该有害物质在该部件所有均质材料中的含量均在GB/T 26572规定的限量要求以下。

X: 表示该有害物质至少在该部件的某一均质材料中的含量超出GB/T 26572规定的限量要求。

本表中标有“X”的所有部件均符合欧盟RoHS法规

This table is made according to SJ/T 11364.

O: indicates that the concentration of hazardous substance in all of the homogeneous materials for this part is below the limit as stipulated in GB/T 26572.

X: indicates that the concentration of hazardous substance in at least one of the homogeneous materials used for this part is above the limit as stipulated in GB/T 26572.

All the parts with “X” comply with EU ROHS

USA: +1 888-444-1311  
Europe: +46 10 478 2000  
Asia: +65 6484 7877  
www.schneider-electric.com

Life Is On

Schneider  
Electric