



# IME08-06NNOZT0S

IME

INDUCTIVE PROXIMITY SENSORS

**SICK**  
Sensor Intelligence.



### Ordering information

| Type            | Part no. |
|-----------------|----------|
| IME08-06NNOZT0S | 1071211  |

**Included in delivery:** BEF-MU-M08 (1)

Other models and accessories → [www.sick.com/IME](http://www.sick.com/IME)

Illustration may differ



### Detailed technical data

#### Features

|  |   |
|--|---|
| <b>Housing</b>                             | Cylindrical thread design               |
| <b>Housing</b>                             | Standard design                         |
| <b>Thread size</b>                         | M8 x 1                                  |
| <b>Diameter</b>                            | Ø 8 mm                                  |
| <b>Sensing range <math>S_n</math></b>      | 6 mm                                    |
| <b>Safe sensing range <math>S_a</math></b> | 4.86 mm                                 |
| <b>Installation type</b>                   | Non-flush                               |
| <b>Switching frequency</b>                 | 500 Hz                                  |
| <b>Connection type</b>                     | Connector M8, 3-pin                     |
| <b>Switching output</b>                    | NPN                                     |
| <b>Output function</b>                     | NC                                      |
| <b>Electrical wiring</b>                   | DC 3-wire                               |
| <b>Enclosure rating</b>                    | IP67 <sup>1)</sup>                      |
| <b>Special features</b>                    | Triple sensing range                    |
| <b>Items supplied</b>                      | Mounting nut, brass, nickel-plated (2x) |

<sup>1)</sup> According to EN 60529.

#### Mechanics/electronics

|                       |                     |
|-----------------------|---------------------|
| <b>Supply voltage</b> | 10 V DC ... 30 V DC |
| <b>Ripple</b>         | ≤ 10 %              |
| <b>Voltage drop</b>   | ≤ 2 V <sup>1)</sup> |

<sup>1)</sup> At  $I_a$  max.

<sup>2)</sup> Supply voltage  $U_B$  and constant ambient temperature  $T_a$ .

<sup>3)</sup> Of  $S_r$ .

|   |                                   |
|---|-----------------------------------|
| <b>Time delay before availability</b>       | ≤ 50 ms                           |
| <b>Hysteresis</b>                           | 1 % ... 15 %                      |
| <b>Reproducibility</b>                      | ≤ 5 % <sup>2) 3)</sup>            |
| <b>Temperature drift (of S<sub>r</sub>)</b> | ± 10 %                            |
| <b>EMC</b>                                  | According to EN 60947-5-2         |
| <b>Continuous current I<sub>a</sub></b>     | ≤ 200 mA                          |
| <b>No load current</b>                      | ≤ 10 mA                           |
| <b>Short-circuit protection</b>             | ✓                                 |
| <b>Reverse polarity protection</b>          | ✓                                 |
| <b>Power-up pulse protection</b>            | ✓                                 |
| <b>Shock and vibration resistance</b>       | 30 g, 11 ms/10 Hz ... 55 Hz, 1 mm |
| <b>Ambient operating temperature</b>        | -25 °C ... +75 °C                 |
| <b>Ambient temperature, storage</b>         | -25 °C ... +75 °C                 |
| <b>Housing material</b>                     | Brass, nickel-plated              |
| <b>Sensing face material</b>                | Plastic, PA 66                    |
| <b>Housing length</b>                       | 50 mm                             |
| <b>Thread length</b>                        | 30 mm                             |
| <b>Tightening torque, max.</b>              | ≤ 5 Nm                            |
| <b>UL File No.</b>                          | NRKH.E181493                      |

<sup>1)</sup> At I<sub>a</sub> max.

<sup>2)</sup> Supply voltage U<sub>B</sub> and constant ambient temperature T<sub>a</sub>.

<sup>3)</sup> Of S<sub>r</sub>.

### Safety-related parameters

|                         |             |
|-------------------------|-------------|
| <b>MTTF<sub>D</sub></b> | 1,735 years |
| <b>DC<sub>avg</sub></b> | 0 %         |

### Reduction factors

|                                   |  |
|-----------------------------------|--|
| <b>Note</b>                       | The values are reference values which may vary |
| <b>St37 steel (Fe)</b>            | 1  |
| <b>Stainless steel (V2A, 304)</b> | Approx. 0.68                                   |
| <b>Aluminum (Al)</b>              | Approx. 0.45                                   |
| <b>Copper (Cu)</b>                | Approx. 0.39                                   |
| <b>Brass (Br)</b>                 | Approx. 0.49                                   |

### Installation note

|               |                                       |
|---------------|---------------------------------------|
| <b>Remark</b> | Associated graphic see "Installation" |
| <b>A</b>      | 16 mm                                 |
| <b>B</b>      | 30 mm                                 |
| <b>C</b>      | 8 mm                                  |
| <b>D</b>      | 18 mm                                 |
| <b>E</b>      | 10 mm                                 |
| <b>F</b>      | 60 mm                                 |

Classifications

|                       |          |
|-----------------------|----------|
| <b>ECLASS 5.0</b>     | 27270101 |
| <b>ECLASS 5.1.4</b>   | 27270101 |
| <b>ECLASS 6.0</b>     | 27270101 |
| <b>ECLASS 6.2</b>     | 27270101 |
| <b>ECLASS 7.0</b>     | 27270101 |
| <b>ECLASS 8.0</b>     | 27270101 |
| <b>ECLASS 8.1</b>     | 27270101 |
| <b>ECLASS 9.0</b>     | 27270101 |
| <b>ECLASS 10.0</b>    | 27270101 |
| <b>ECLASS 11.0</b>    | 27270101 |
| <b>ECLASS 12.0</b>    | 27274001 |
| <b>ETIM 5.0</b>       | EC002714 |
| <b>ETIM 6.0</b>       | EC002714 |
| <b>ETIM 7.0</b>       | EC002714 |
| <b>ETIM 8.0</b>       | EC002714 |
| <b>UNSPSC 16.0901</b> | 39122230 |

Installation note

Non-flush installation

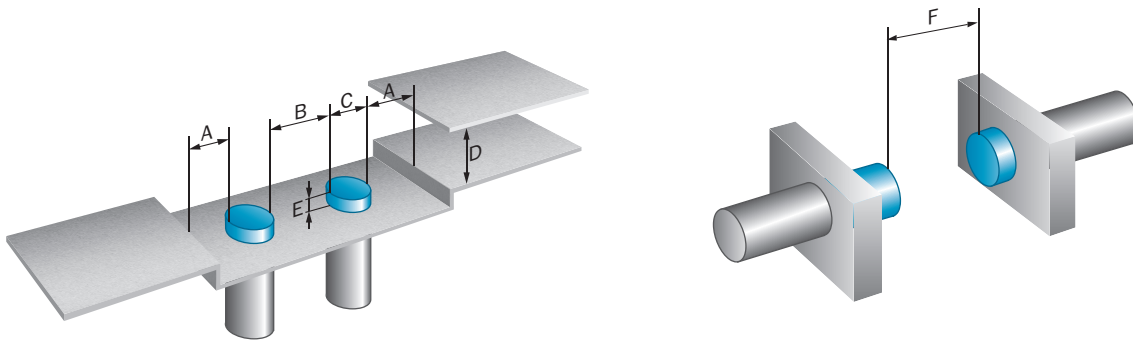

Connection type

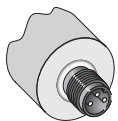

## Connection diagram

Cd-004

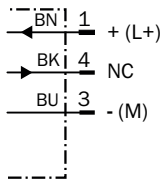

## Dimensional drawing (Dimensions in mm (inch))



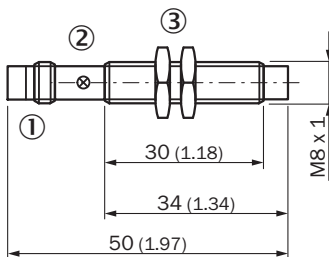

IME08 standard, male connector, non-flush



- ① Connection
- ② Display LED
- ③ Fastening nuts (2x); width across 13, metal

## Recommended accessories

Other models and accessories → [www.sick.com/IME](http://www.sick.com/IME)

|   | Brief description   | Type       | Part no. |
|---|---|------------|----------|
| <b>Mounting brackets and plates</b>   |   |            |          |
|  | Mounting plate for M8 sensors, steel, zinc coated, without mounting hardware  | BEF-WG-M08 | 5321722  |
|  | Mounting bracket for M8 sensors, steel, zinc coated, without mounting hardware  | BEF-WN-M08 | 5321721  |
| <b>Plug connectors and cables</b>   |   |            |          |
|  | <ul style="list-style-type: none"> <li><b>Connection type head A:</b> Female connector, M8, 3-pin, straight</li> <li><b>Description:</b> Unshielded</li> <li><b>Connection systems:</b> Screw-type terminals</li> <li><b>Permitted cross-section:</b> 0.14 mm<sup>2</sup> ... 0.5 mm<sup>2</sup></li> </ul> | DOS-0803-G | 7902077  |
|  | <ul style="list-style-type: none"> <li><b>Connection type head A:</b> Female connector, M8, 3-pin, angled</li> <li><b>Description:</b> Unshielded</li> <li><b>Connection systems:</b> Solder connection</li> <li><b>Permitted cross-section:</b> ≤ 0.25 mm<sup>2</sup></li> </ul>                           | DOS-0803-W | 7902078  |

|   | Brief description   | Type               | Part no. |
|---|---|--------------------|----------|
| Terminal and alignment brackets   |   |                    |          |
|    | Clamping block for round sensors M8, without fixed stop, plastic (PA12), glass-fiber reinforced, mounting hardware included   | BEF-KH-M08         | 2051477  |
|   | Clamping block for round sensors M8, with fixed stop, plastic (PA12), glass-fiber reinforced, mounting hardware included  | BEF-KHF-M08        | 2051478  |
| Others  |   |                    |          |
|    | <ul style="list-style-type: none"> <li>• <b>Connection type head A:</b> Female connector, M8, 3-pin, straight, A-coded</li> <li>• <b>Connection type head B:</b> Flying leads</li> <li>• <b>Signal type:</b> Sensor/actuator cable</li> <li>• <b>Cable:</b> 2 m, 3-wire, PVC</li> <li>• <b>Description:</b> Sensor/actuator cable, unshielded</li> <li>• <b>Application:</b> Zones with chemicals</li> </ul>  | YF8U13-020VA1XLEAX | 2095860  |
|    | <ul style="list-style-type: none"> <li>• <b>Connection type head A:</b> Female connector, M8, 3-pin, straight, A-coded</li> <li>• <b>Connection type head B:</b> Flying leads</li> <li>• <b>Signal type:</b> Sensor/actuator cable</li> <li>• <b>Cable:</b> 5 m, 3-wire, PVC</li> <li>• <b>Description:</b> Sensor/actuator cable, unshielded</li> <li>• <b>Application:</b> Zones with chemicals</li> </ul>  | YF8U13-050VA1XLEAX | 2095884  |
|    | <ul style="list-style-type: none"> <li>• <b>Connection type head A:</b> Female connector, M8, 3-pin, straight, A-coded</li> <li>• <b>Connection type head B:</b> Flying leads</li> <li>• <b>Signal type:</b> Sensor/actuator cable</li> <li>• <b>Cable:</b> 10 m, 3-wire, PVC</li> <li>• <b>Description:</b> Sensor/actuator cable, unshielded</li> <li>• <b>Application:</b> Zones with chemicals</li> </ul> | YF8U13-100VA1XLEAX | 2095885  |
|   | <ul style="list-style-type: none"> <li>• <b>Connection type head A:</b> Female connector, M8, 3-pin, angled, A-coded</li> <li>• <b>Connection type head B:</b> Flying leads</li> <li>• <b>Signal type:</b> Sensor/actuator cable</li> <li>• <b>Cable:</b> 2 m, 3-wire, PVC</li> <li>• <b>Description:</b> Sensor/actuator cable, unshielded</li> <li>• <b>Application:</b> Zones with chemicals</li> </ul>    | YG8U13-020VA1XLEAX | 2096165  |
|  | <ul style="list-style-type: none"> <li>• <b>Connection type head A:</b> Female connector, M8, 3-pin, angled, A-coded</li> <li>• <b>Connection type head B:</b> Flying leads</li> <li>• <b>Signal type:</b> Sensor/actuator cable</li> <li>• <b>Cable:</b> 5 m, 3-wire, PVC</li> <li>• <b>Description:</b> Sensor/actuator cable, unshielded</li> <li>• <b>Application:</b> Zones with chemicals</li> </ul>    | YG8U13-050VA1XLEAX | 2096166  |
|  | <ul style="list-style-type: none"> <li>• <b>Connection type head A:</b> Female connector, M8, 3-pin, angled, A-coded</li> <li>• <b>Connection type head B:</b> Flying leads</li> <li>• <b>Signal type:</b> Sensor/actuator cable</li> <li>• <b>Cable:</b> 10 m, 3-wire, PVC</li> <li>• <b>Description:</b> Sensor/actuator cable, unshielded</li> <li>• <b>Application:</b> Zones with chemicals</li> </ul>   | YG8U13-100VA1XLEAX | 2096209  |

## SICK AT A GLANCE

SICK is one of the leading manufacturers of intelligent sensors and sensor solutions for industrial applications. A unique range of products and services creates the perfect basis for controlling processes securely and efficiently, protecting individuals from accidents and preventing damage to the environment.

We have extensive experience in a wide range of industries and understand their processes and requirements. With intelligent sensors, we can deliver exactly what our customers need. In application centers in Europe, Asia and North America, system solutions are tested and optimized in accordance with customer specifications. All this makes us a reliable supplier and development partner.

Comprehensive services complete our offering: SICK LifeTime Services provide support throughout the machine life cycle and ensure safety and productivity.

For us, that is “Sensor Intelligence.”

## WORLDWIDE PRESENCE:

Contacts and other locations –[www.sick.com](http://www.sick.com)