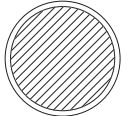
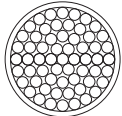

## CABLE CUTTER TOOL

Part No.: CCT-340

	Approx. 1.0" (25.4 mm) CU / AL
	Approx. 1.33" (34 mm) CU / AL

**CU (max.) 600 MCM (300mm<sup>2</sup>)**  
**AL (max.) 750 MCM (380mm<sup>2</sup>)**

MADE IN GERMANY

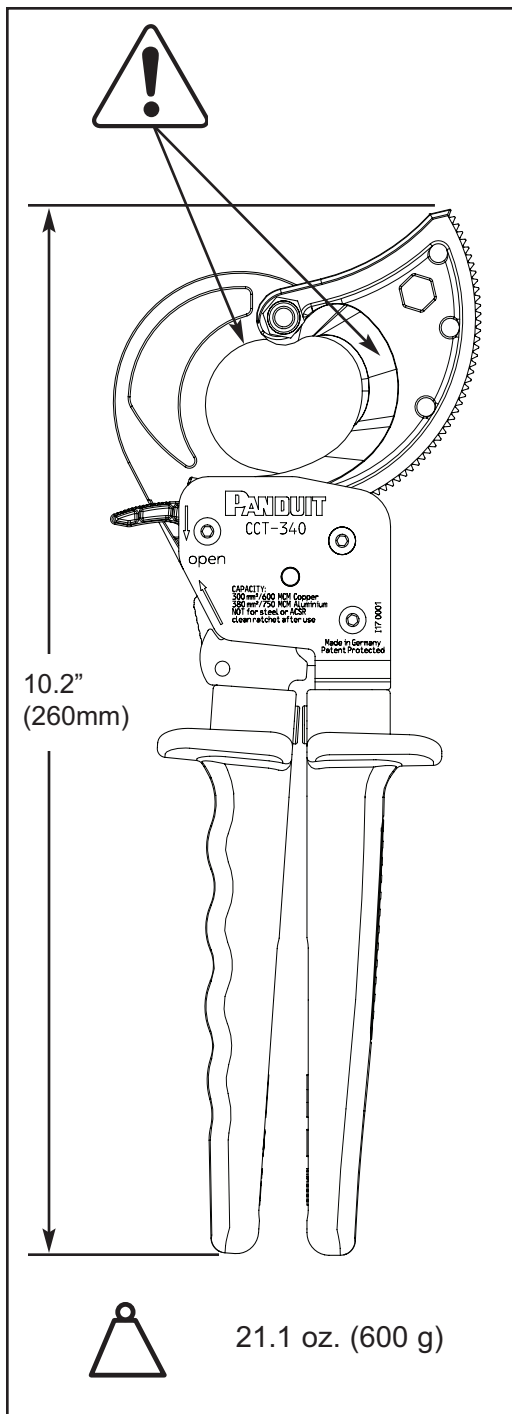

© Panduit Corp. 2018

	<b>CAUTION</b>
<p><b>CAUTION:</b> Cutting blades are sharp!</p> <p><b>VORSICHT:</b> Schneidklingen sind scharf!</p> <p><b>ATTENTION:</b> Lames de coupe sont affûtées!</p> <p><b>ATTENZIONE:</b> Lame taglienti!</p> <p><b>PRECAUCIÓN:</b> Las chuchillas de corte están afiladas!</p> <p><b>LET OP:</b> Snijbladen zijn scherp!</p> <p><b>HUOMIO:</b> Leikkuuterät ovat teräviä!</p> <p><b>FORSIKTIG:</b> Skjærebladene er skarpe!</p> <p><b>FORSIGTIG:</b> Knivene er skarpe!</p> <p><b>FÖRSIKTIG:</b> Skärbladen är vassa!</p> <p><b>UPOZORNENÍ:</b> Ostré brity!</p>	

	<b>CAUTION</b>
<p><b>CAUTION:</b> Keep hands off cutting area</p> <p><b>VORSICHT:</b> Halten Sie Ihre Hände fern vom Schneidebereich</p> <p><b>ATTENTION:</b> Gardez les mains en dehors de la zone de coupe</p> <p><b>ATTENZIONE:</b> Non avvicinare le mani alle superfici taglienti</p> <p><b>PRECAUCIÓN:</b> Mantenga las manos fuera la zona de corte</p> <p><b>LET OP:</b> Houd uw handen af maaigebied</p> <p><b>HUOMIO:</b> Pidä kädet pois leikkuu alueelta</p> <p><b>FORSIKTIG:</b> Hold hendene borte fra skjære omerådet</p> <p><b>FORSIGTIG:</b> Hold hænderne væk fra skære området</p> <p><b>FÖRSIKTIG:</b> Håll händerna borta från skärområdet</p> <p><b>UPOZORNENÍ:</b> Nedotýkejte se rezacích částí!</p>	

	<b>CAUTION</b>
<p><b>CAUTION:</b> Do Not cut live circuits</p> <p><b>VORSICHT:</b> Kein Durchtrennen von Schaltkreisen</p> <p><b>ATTENTION:</b> Ne coupez pas les circuits sous tensions</p> <p><b>ATTENZIONE:</b> Non tagliare circuiti in funzione</p> <p><b>PRECAUCIÓN:</b> No cortar los circuitos de baja tensión</p> <p><b>LET OP:</b> Niet in een onder spanning stand kabel snijden</p> <p><b>HUOMIO:</b> Älä leikkaa piirejä jotka ovat jännitteisiä</p> <p><b>FORSIKTIG:</b> Skjør ikke de elektriske kretser</p> <p><b>FORSIGTIG:</b> Der må ikke skæres strømførende kredsløb</p> <p><b>FÖRSIKTIG:</b> Skär inte strömförande kretsar</p> <p><b>UPOZORNENÍ:</b> Nepoužívejte pro strih obvodu pod proudem</p>	

	<b>CAUTION</b>
<p><b>CAUTION:</b> Do Not cut Steel or ASCR</p> <p><b>VORSICHT:</b> Kein Durchtrennen von Stahl oder ASCR</p> <p><b>ATTENTION:</b> Ne pas couper l'acier ou ASCR</p> <p><b>ATTENZIONE:</b> Non tagliare l'acciaio o l'ASCR</p> <p><b>PRECAUCIÓN:</b> No cortar ni el acero ni ASCR</p> <p><b>LET OP:</b> Niet geschikt voor snijden van staal of ASCR</p> <p><b>HUOMIO:</b> Älä leikkaa terästä tai ASCR</p> <p><b>FORSIKTIG:</b> Skjør ikke stål eller ASCR</p> <p><b>FORSIGTIG:</b> Der må ikke skæres af stål eller ASCR</p> <p><b>FÖRSIKTIG:</b> Skär inte stål eller ASCR</p> <p><b>UPOZORNENÍ:</b> Nepoužívejte pro rezání oceli nebo ASCR</p>	

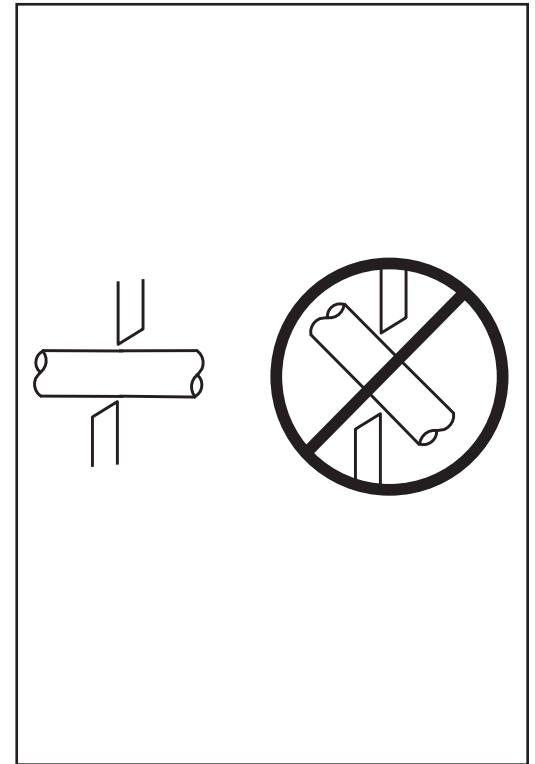
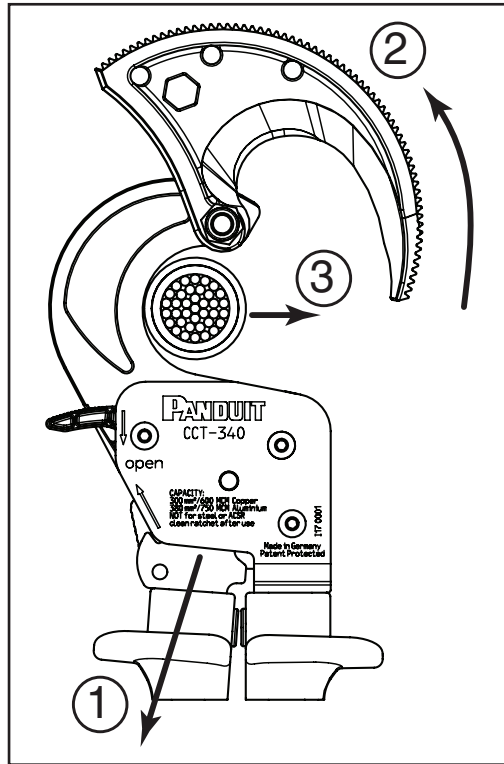
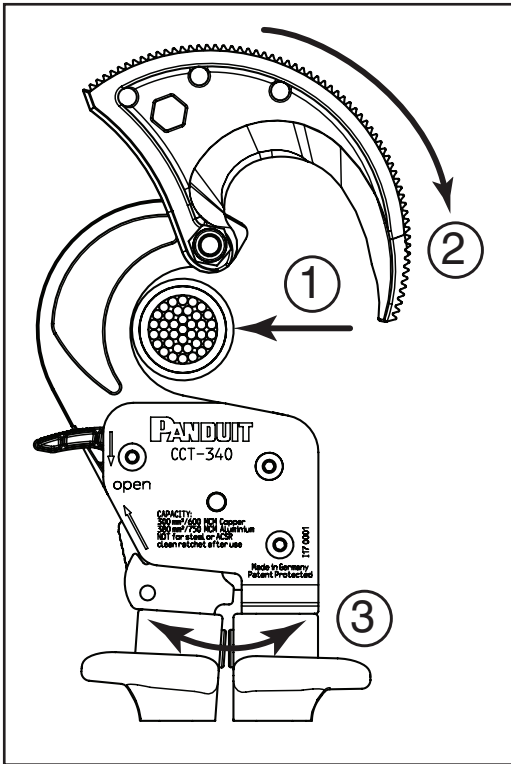

# PANDUIT

[www.panduit.com](http://www.panduit.com)

**Panduit Technical Support**

**1-800-777-3300**

**E-mail: [techsupport@panduit.com](mailto:techsupport@panduit.com)**

**Panduit Europe, EMEA Headquarters**

**Tel: 31 (0) 546 580 452 • Fax: 31 (0) 546 580 441**

**EU Website: [www.panduit.com/emea](http://www.panduit.com/emea)**

**EU E-mail: [emeatoolservicecenter@panduit.com](mailto:emeatoolservicecenter@panduit.com)**