

QRG

FLUKE

True
RMS

T6-1000 PRO Electrical Tester with FieldSense Technology

⚠️ 📖 Consultez les Consignes de sécurité

Rendez-vous sur www.fluke.com pour enregistrer votre produit et obtenir davantage d'informations, ou pour télécharger le présent Aide-mémoire dans d'autres langues. Les consignes générales de sécurité se trouvent dans le document imprimé relatif aux Consignes de sécurité fourni avec le produit. Des consignes de sécurité plus spécifiques peuvent être fournies en cas échéant. Les spécifications complètes sont disponibles sur le site www.fluke.com.

17,8 mm (0,7 po)

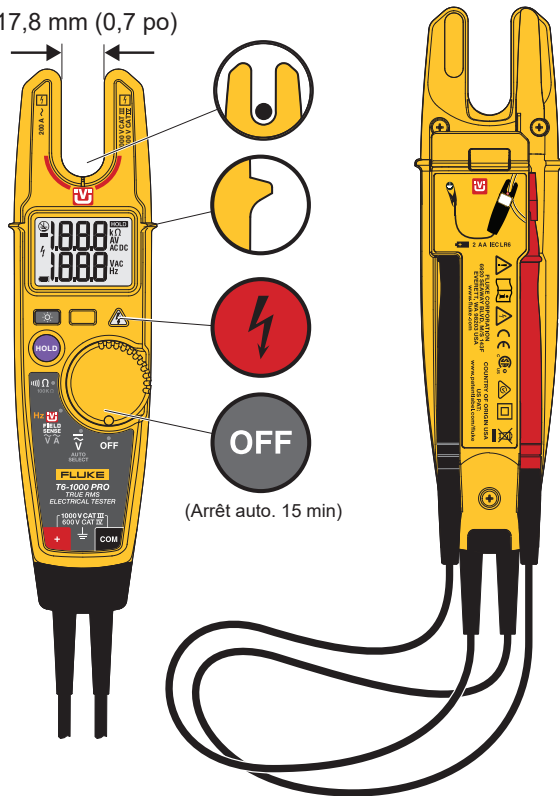

Symboles

	Tension dangereuse : 30 V.
	Test avec fourche et sonde de terre, ou pince crocodile.
	Batterie pleine charge.
	Batterie faible. Remplacer.
	Rétro-éclairage
	Test avec sondes.
	Pas de mise à la terre.



Position du câble

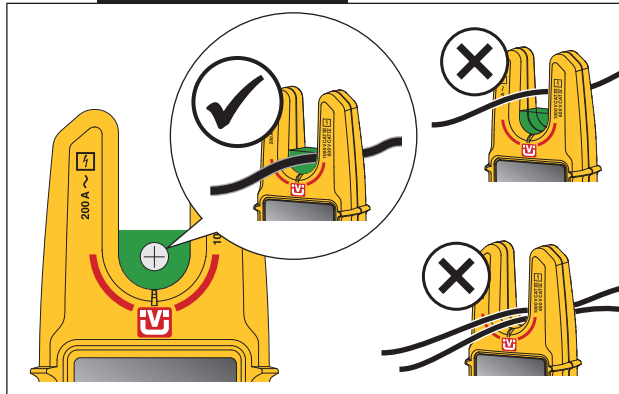

Protection des doigts

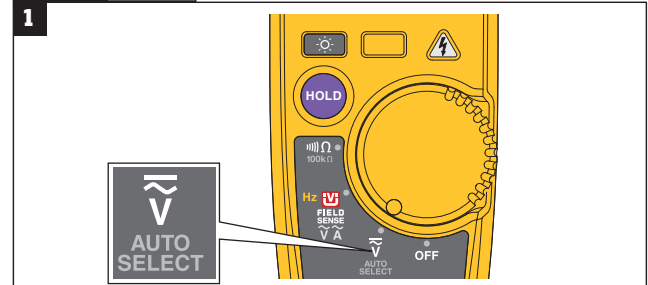
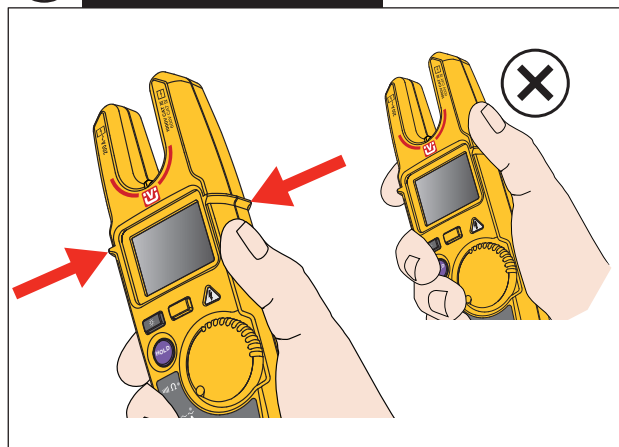

2A

\tilde{V} (AC)

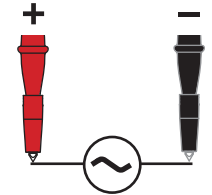

2B

\bar{V} (DC)

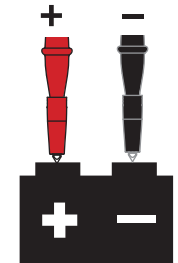

HOLD

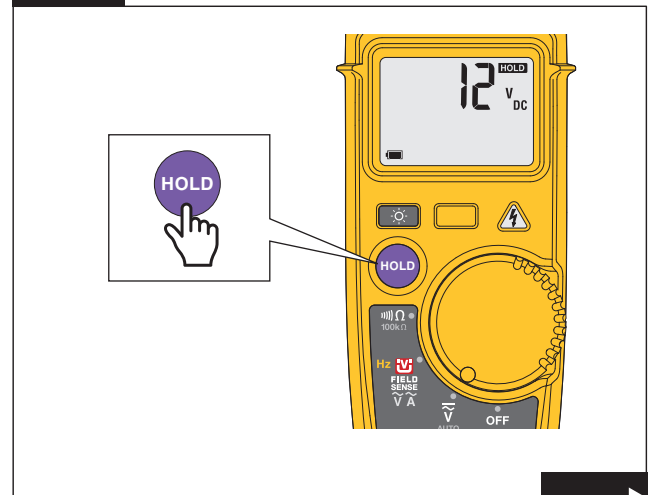

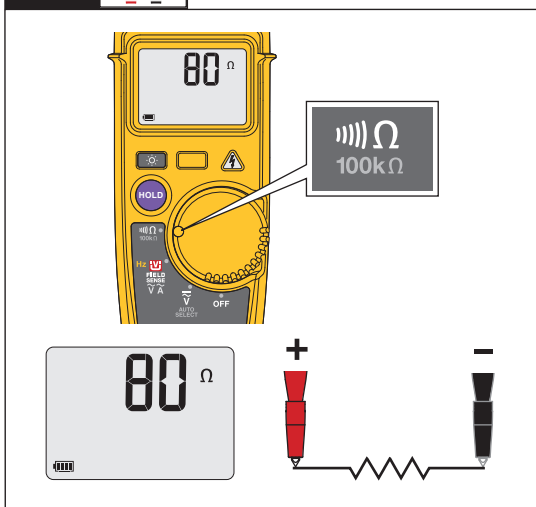
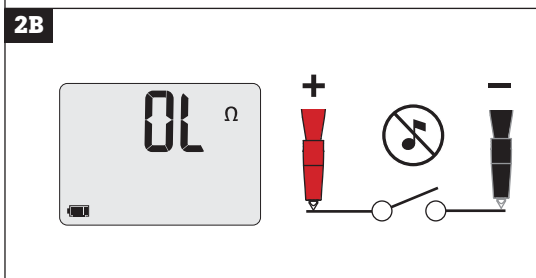
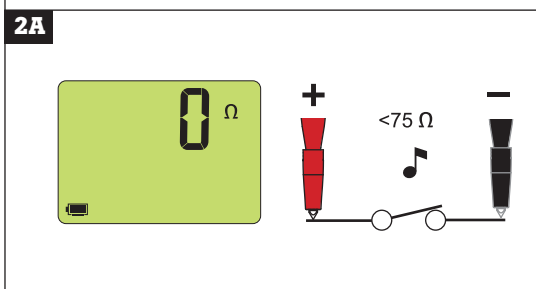
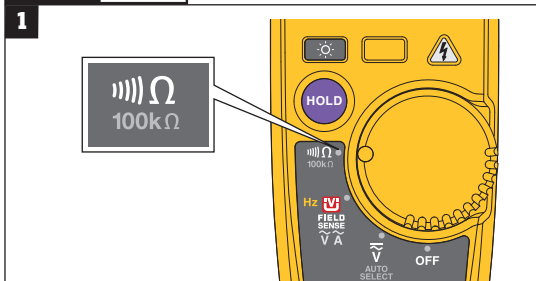
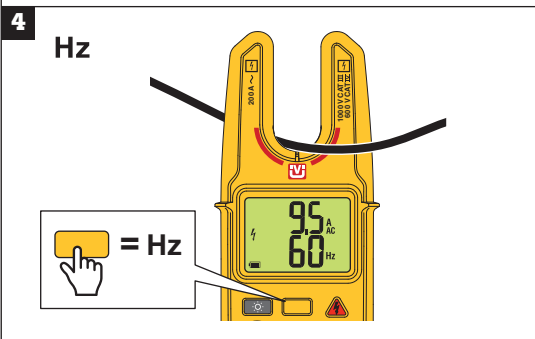
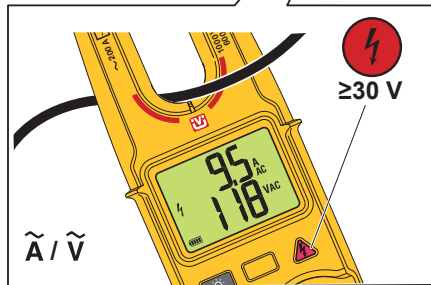
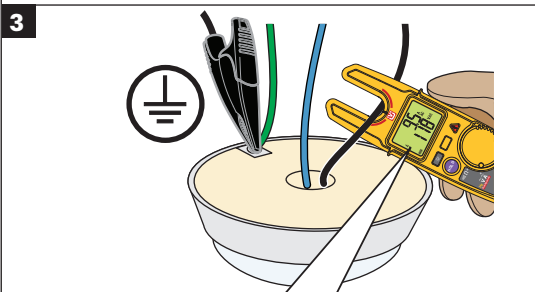
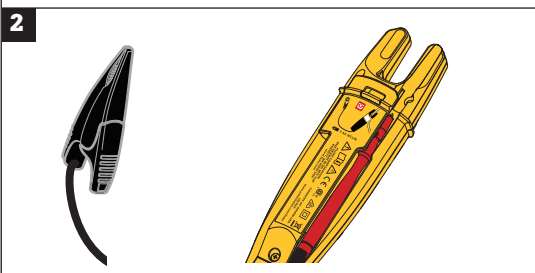
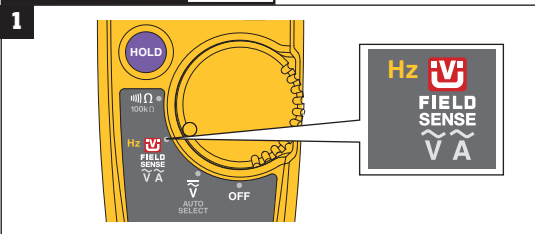

Remplacement des cordons

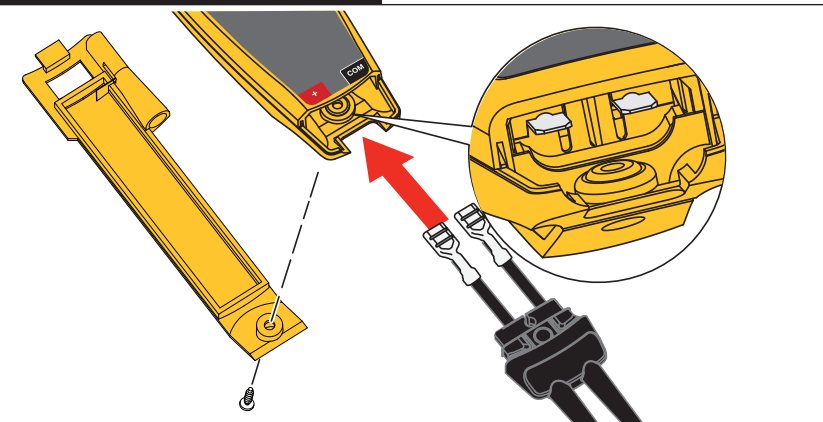

Pièces de rechange

Ensemble de cordons de mesure (T5-RLS) A remplacer uniquement par des cordons double isolation Fluke.	PN 4462973
Sonde unique TP1, pointe plate, rouge	PN 648128
Sonde unique TP1, pointe plate, noire	PN 648102
Sonde unique TP38, pointe arrondie, rouge	PN 1276841
Sonde unique TP38, pointe arrondie, noire	PN 1276852
Couvercle du compartiment des piles	PN 5132103
Vis du couvercle du compartiment des piles	PN 1618578
Pince crocodile AC285	PN 1610159
Etui pour ceinture H-T6	PN 4910585

