

TeSys™ T LTMCU / LTMCUF

Control Operator Unit

User Manual

1639581EN-06

12/2022



Legal Information

The Schneider Electric brand and any trademarks of Schneider Electric SE and its subsidiaries referred to in this guide are the property of Schneider Electric SE or its subsidiaries. All other brands may be trademarks of their respective owners.

This guide and its content are protected under applicable copyright laws and furnished for informational use only. No part of this guide may be reproduced or transmitted in any form or by any means (electronic, mechanical, photocopying, recording, or otherwise), for any purpose, without the prior written permission of Schneider Electric.

Schneider Electric does not grant any right or license for commercial use of the guide or its content, except for a non-exclusive and personal license to consult it on an "as is" basis. Schneider Electric products and equipment should be installed, operated, serviced, and maintained only by qualified personnel.

As standards, specifications, and designs change from time to time, information contained in this guide may be subject to change without notice.

To the extent permitted by applicable law, no responsibility or liability is assumed by Schneider Electric and its subsidiaries for any errors or omissions in the informational content of this material or consequences arising out of or resulting from the use of the information contained herein.

Table of Contents

Safety Information.....	5
Please Note	5
About the Book.....	6
Chapter 1.....	7
Introducing the LTMCU Control Operator Unit.....	7
Presentation of the LTMCU Control Operator Unit	7
Installing SoMove and the TeSys DTM Library.....	8
Technical Specifications of the LTMCU	9
Chapter 2.....	11
Installing the LTMCU Control Operator Unit	11
LTMCU Dimensions	11
Inserting the Local Control Interface Label	11
Flush Mounting the LTMCU	13
Mounting a Portable LTMCU.....	16
Connecting the LTMCU	18
Chapter 3.....	21
Language Management	21
Presentation of LTMCU Langtool.....	21
Using LTMCU Langtool	22
Chapter 4.....	28
Using the LTMCU Control Operator Unit.....	28
LTMCU Physical Description.....	28
Parameter Display	31
Quick View Display	33
Trips and Alarms Display.....	35
Using the Local Control Interface	36
Navigating the Menu Structure.....	39
Editing Values.....	40
Password Access	42
Selecting the Language Displayed by the LTMCU	43
First Setup Menu	43
Main Menu	44
Menu - Metering Setting	45
Menu - Protection Setting	46
Menu - Control Setting.....	49
Menu - Services.....	51
Chapter 5.....	58
Using the LTMCU Control Operator Unit with FDR (Fast Device Replacement).....	58
Presentation of the LTMCUF Control Operator Unit	58
Principles.....	59
Using LTMCUF (Fast Device Replacement)	60
HMI FDR settings	62
Menu – FDR settings	64
Troubleshooting	65
Index	67

Safety Information

Read these instructions carefully and look at the equipment to become familiar with the device before trying to install, operate, service, or maintain it. The following special messages may appear throughout this bulletin or on the equipment to warn of hazards or to call attention to information that clarifies or simplifies a procedure.



The addition of either symbol to a “Danger” or “Warning” safety label indicates that an electrical hazard exists which will result in personal injury if the instructions are not followed.

This is the safety alert symbol. It is used to alert you to personal injury hazards. Obey all safety messages that follow this symbol to avoid possible injury or death.

⚡ ⚠ DANGER
DANGER indicates a hazardous situation which, if not avoided, will result in death or serious injury.
⚠ WARNING
WARNING indicates a hazardous situation which, if not avoided, could result in death or serious injury.
⚠ CAUTION
CAUTION indicates a hazardous situation which, if not avoided, could result in minor or moderate injury.
NOTICE
NOTICE is used to address practices not related to physical injury.

NOTE: Provides additional information to clarify or simplify a procedure.

Please Note

Electrical equipment should be installed, operated, serviced, and maintained only by qualified personnel. No responsibility is assumed by Schneider Electric for any consequences arising out of the use of this material.

A qualified person is one who has skills and knowledge related to the construction and operation of electrical equipment and its installation, and has received safety training to recognize and avoid the hazards involved.

About the Book

At a Glance

Document Scope

This manual describes how to install, configure and use the TeSys® T LTMCU Control Operator Unit.

The firmware version of the LTMR connected to the LTMCU must be LTMCU compliant: the LTMR firmware version must be 2.1 and above.

Validity Note

This manual is valid for all LTMCU Control Operator Units. The availability of some functions depends on the software version of the Control Operator Unit.

Title of Documentation	Reference Number
TeSys® T LTMR Modbus Motor Management Controller User Manual	1639501
TeSys® T LTMR Profibus Motor Management Controller User Manual	1639502
TeSys® T LTMR CANopen Motor Management Controller User Manual	1639503
TeSys® T LTMR DeviceNet Motor Management Controller User Manual	1639504
TeSys® T LTMR Ethernet TCP/IP Motor Management Controller User Manual	1639505
TeSys® T LTMCU** Instruction Sheet	1639582

You can download these technical publications and other technical information from our website at www.se.com .

Proposition 65 Notice



WARNING: This product can expose you to chemicals including lead and lead compounds, which are known to the State of California to cause cancer and birth defects or other reproductive harm. For more information go to www.P65Warnings.ca.gov.

Chapter 1

Introducing the LTMCU Control Operator Unit

Overview

This chapter introduces the LTMCU Control Operator Unit, and describes its function and technical specifications.

Presentation of the LTMCU Control Operator Unit

Aim of the Product

The LTMCU Control Operator Unit is a remote operator terminal that enables the configuration, monitoring and control of the LTMR controller, as part of the TeSys® T Motor Management System. The LTMCU has been specially developed to act as the Human Machine Interface (HMI) of the LTMR controller, and is internally powered by the LTMR.

The diagram below shows the LTM CU front face:

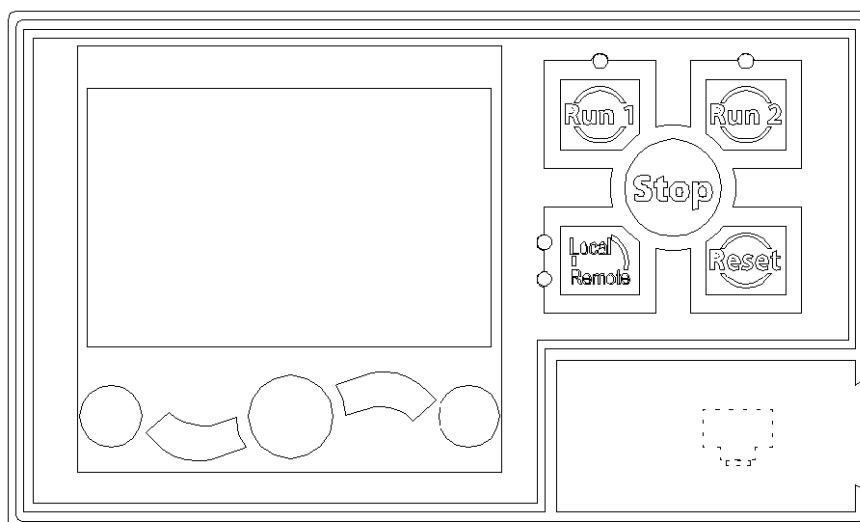

LTMCU Functions

The LTMCU can be used to:

- configure parameters for the LTMR controller,
- display information about the LTMR controller configuration and operation,
- monitor trips and alarms by the controller,
- control the motor locally using the local control interface.

LTMCU Languages

The LTMCU can display languages thanks to an embedded dictionary. The default (factory) language is English. You can also download and install 2 other languages via www.se.com. For more information on downloading languages, see Language Management, page 21.

Configuring the LTMR Controller Using SoMove™ with the TeSys T DTM

The LTMR controller can be configured using the LTMCU or a PC running SoMove with the TeSys TDTM., page 8.

SoMove software is a Microsoft® Windows®-based application, using the open FDT/DTM technology.

SoMove contains many DTMs. The TeSys T DTM is a specific DTM that enables the configuration, monitoring, control, and customization of the control functions of the LTMR controller, as part of the TeSys® T motor management system.

LTMCU Assembly

There are 2 ways to use the LTMCU:

- as a fixed HMI device, flush mounted in a panel and continuously connected to one LTMR controller , page 13, or
- as a portable HMI device, used from time to time to set and monitor several LTMR controllers. A separate kit (reference LTM9KCU) can be used to mount the portable LTMCU.

More Information in LTMR User's Manuals

The User's Manual of the LTMR controller used is complementary to the present manual and needed for the system implementation. It contains the following information:

- description of the functions (metering and monitoring, protection and control),
- parameter values (including factory default),
- installation and commissioning.

Installing SoMove and the TeSys DTM Library

Overview

The installation of SoMove includes some DTMs such as the TeSys DTM library.

The TeSys DTM library includes:

- TeSys T DTM
- TeSys U DTM

These DTM are automatically installed during the SoMove installation process.

Downloading SoMove

SoMove can be downloaded from the Schneider Electric website (www.se.com) by entering `SoMove Lite` in the **Search** field.

Installing SoMove

Step	Action
1	Unzip the downloaded file: the SoMove file is unzipped in a folder named <code>SoMove_Lite - V.X.X.X.X</code> (where X.X.X.X is the version number). Open this folder and double-click setup.exe .
2	In the Choose Setup Language dialog box, select the installation language.
3	Click OK .

Step	Action
4	In the Welcome to the Installation Wizard for SoMove Lite dialog box, click the Next button.
5	If an Install Shield Wizard dialog box appears and informs you that you must install Modbus driver, click the Install button. Result: Modbus driver is installed automatically.
6	In the Readme and Release Notes dialog box, click the Next button.
7	In the Readme dialog box, click the Next button.
8	In the License Agreement dialog box: <ul style="list-style-type: none"> • Read carefully the license agreement. • Select I accept the terms in the license agreement option. • Click the Next button.
9	In the Customer Information dialog box: <ul style="list-style-type: none"> • Enter the following information in the corresponding fields: <ul style="list-style-type: none"> ◦ First name ◦ Last name ◦ Company name • Select an installation option: <ul style="list-style-type: none"> ◦ Either the Anyone who uses this computer option if SoMove Lite is used by all users of this computer, or ◦ Only for me if SoMove Lite is used only by you. • Click the Next button.
10	In the Destination Folder dialog box: <ul style="list-style-type: none"> • If necessary, modify the SoMove Lite destination folder by clicking the Change button. • Click the Next button.
11	In the Shortcuts dialog box: <ul style="list-style-type: none"> • If you want to create a shortcut on the desktop and/or in the quick launch bar, select the corresponding options. • Click the Next button.
12	In the Ready to Install the Program dialog box, click the Install button. Result: The SoMove Lite components are installed automatically: <ul style="list-style-type: none"> • Modbus communication DTM library which contains the communication protocol • DTM libraries which contain different drive catalogs • SoMove Lite itself
13	In the Installation Wizard Completed dialog box, click the Finish button. Result: SoMove Lite is installed on your computer.

Technical Specifications of the LTMCU

Environmental Characteristics

Certification (1)	UL, CSA, CE, EAC/GOST, RCM/CTIC'K		
Conformity to Standards	IEC/EN 61131-2, UL60947-4-1A, CSA C22.2 no. 60947-4-1		
European community directives	CE marking, satisfies the essential requirements of the low voltage (LV) machinery and electromagnetic compatibility (EMC) directives.		
Ambient air temperature around the device	Storage	-40...+80°C (-40...176°F)	
	Operation	inside cabinet	-20...+60°C (-4...140°F)
		outside cabinet	-20...+55°C (-4...131°F)
Humidity range	15 to 95 % (without condensation)		
Cycled humidity	According to IEC/EN 60068-2-30 (variant 2)	55 °C (131 °F); 12 cycles	
Degree of protection	According to IEC 60947-1 (protection against direct contact)	IP54 (part outside cabinet)	
		IP20 (part inside cabinet)	

	According to NEMA	Type 12 (part outside cabinet) Type 1 (part inside cabinet)
Resistance to shocks	According to IEC 60068-2-27 (2)	Semi-sine mechanical shock impulse: 11 ms, 15 g on 3 axes
Resistance to vibration	According to IEC 60068-2-6 (2)	5...300 Hz: 4 g
Fire resistance	According to IEC 60947-1	650°C (1,202°F)
	According to UL94	V2 V1 for plastic parts on front cover
Degree of pollution	According to IEC/EN 61131	Degree 2
Overvoltage category	According to IEC/EN 61131	II
<p>(1) Some certifications are in progress.</p> <p>(2) NOTICE: This product has been designed for use in Zone A as defined in IEC 61131-2. Use of this product in Zone B may cause unwanted electromagnetic disturbance, which may require the implementation of adequate mitigation measures.</p>		

Electrical Noise Immunity

Immunity to electrostatic discharge	According to EN61000-4-2	Through air	8 kV level 3
		Over surface	6 kV level 3
Radiated RF	According to EN61000-4-3	80 MHz to 2 GHz	10 V/m level 3
Immunity to fast transient bursts	According to EN61000-4-4	Power supply	2 kV level 3
		Communication	1 kV level 3
Immunity to radioelectric fields	According to EN61000-4-6		10 V rms level 3
Surge immunity	According to IEC/EN 61000-4-5	Line to earth/ground	1 kV (2 Λ /18 μ F) level 3
		Line to line	2 kV (2 Λ /18 μ F) level 3

Physical Characteristics

Dimensions	117 x 70 x 55 mm (4.61 x 2.76 x 2.17 in.)	
Mounting	<ul style="list-style-type: none"> Mounted by 1 spring-clip (supplied) for panels 0.8 to 6 mm (0.03 to 0.23 in.) thick Cut-out dimensions: 45 x 92 mm (1.77 x 3.62 in.) 	
Display unit	Type	Backlight LCD
	Backlight	Continuous
	Electrical life with backlight on	70,000 h
Signaling	4 LEDs	
Connection	Front port	RJ45 female (unshielded)
	Rear port	RJ45 female (unshielded)

Chapter 2

Installing the LTMCU Control Operator Unit

Overview

This chapter describes the physical installation and assembly of the LTMCU Control Operator Unit. It also explains how to connect and wire the LTMCU to the LTMR controller or to a PC.

LTMCU Dimensions

LTMCU Dimensions

The dimensions of the LTMCU are shown below:

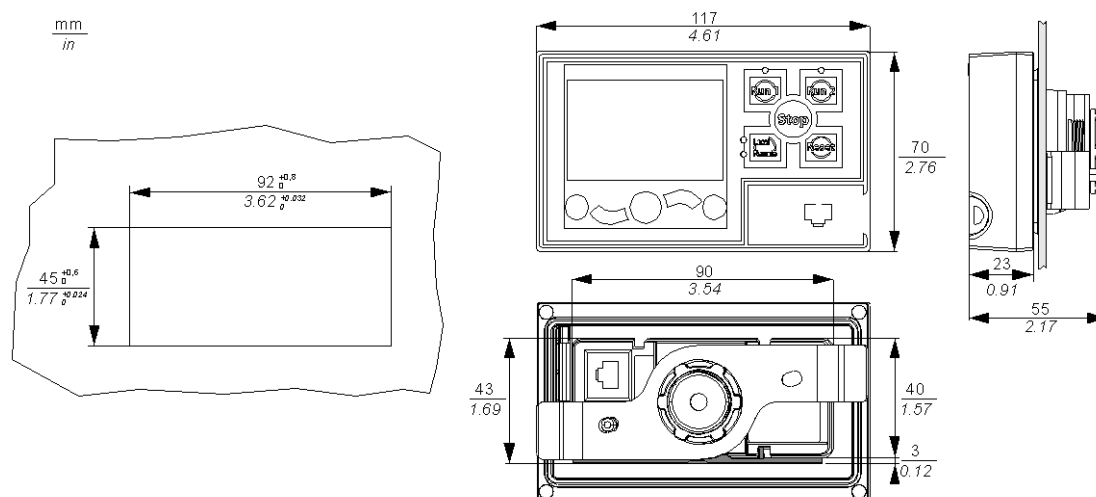

Inserting the Local Control Interface Label

Overview

The local control interface is the part of the LTMCU that contains the 5 control keys and 4 LEDs. To identify these different elements, you can choose:

- one of the pre-defined labels,
- the blank label that you can customize with a pen.

The diagram below shows an example of a pre-defined label:

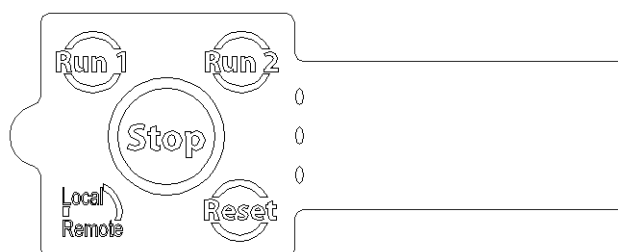

NOTE: The label must be chosen according to the LTMR controller's operating mode. The keys' label on the local control interface must be appropriate to the functions of the LTMR operating mode.

Inserting Labels

To insert a local control interface label:

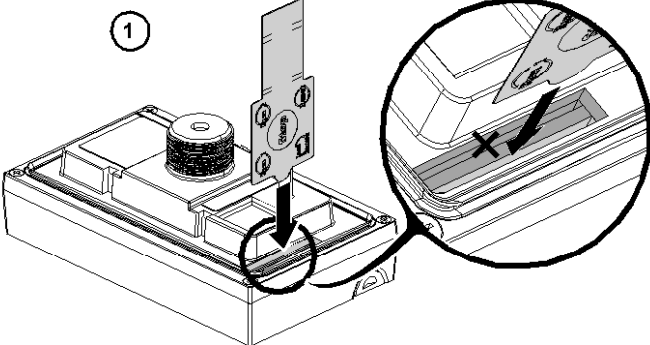
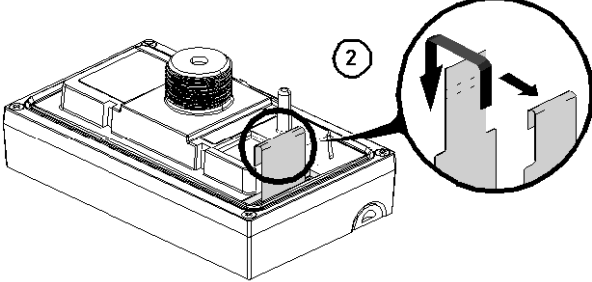
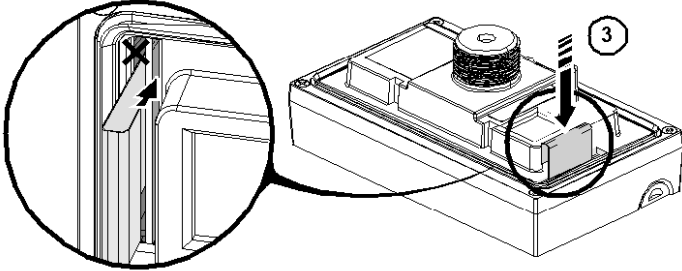
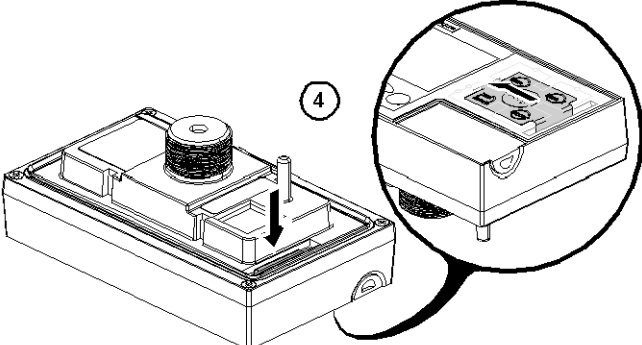
Step	Action
1	<p>Slide the tip of the label into the slit on the side of the LTMCU as shown below.</p> <p>Be careful to use the right slit as shown in the zoom below.</p> 
2	<p>Slide the rest of the label into position in the LTMCU, correctly align the identifiers on the label with the interface elements.</p> 
3	<p>Tuck the label tab into the tab loop, as shown in the diagram below:</p> 
4	<p>Push the tab into place so it lies flat against the loop:</p> 

Flush Mounting the LTMCU

Overview

This section describes how to mount the LTMCU inside a panel cut-out, as well as the accessories needed for mounting.

LTMCU Rear Face

The various elements of the rear face of the LTMCU are shown in the diagram below:

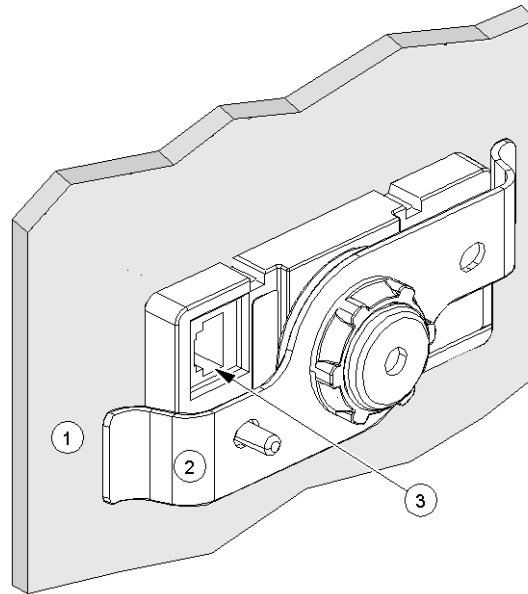

1 Mounting fixation (with mounting nut)

2 Clamp

3 Rear RJ45 port

Panel Setup Procedure

Stage	Description
1	Check that the installation panel or cabinet's surface is flat, in good condition, and has no jagged edges. Metal reinforcing strips can be attached to the inside of the panel, near the panel opening, to increase the panel's rigidity.
2	Panel thickness should be from 0.8 to 6 mm (0.03 to 0.23 in.).
3	Verify that the ambient operation temperature and the ambient humidity are within their designated ranges. (When installing the LTMCU in a cabinet or enclosure, the ambient operation temperature is the cabinet or enclosure's internal temperature.)

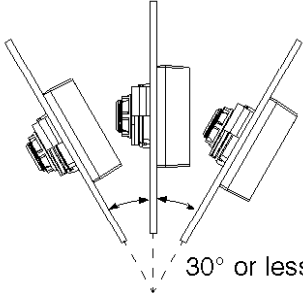
Stage	Description
4	Verify that heat from surrounding equipment does not cause the LTMCU to exceed its standard operating temperature, page 9.
5	<p data-bbox="304 264 1193 293">When installing the LTMCU in a slanted panel, the panel face should not incline more than 30°.</p>  <p data-bbox="304 622 1433 674">When installing the LTMCU in a slanted panel, and the panel face inclines more than 30°, the ambient temperature must not exceed 40°C (104°F).</p>

Mounting the LTMCU

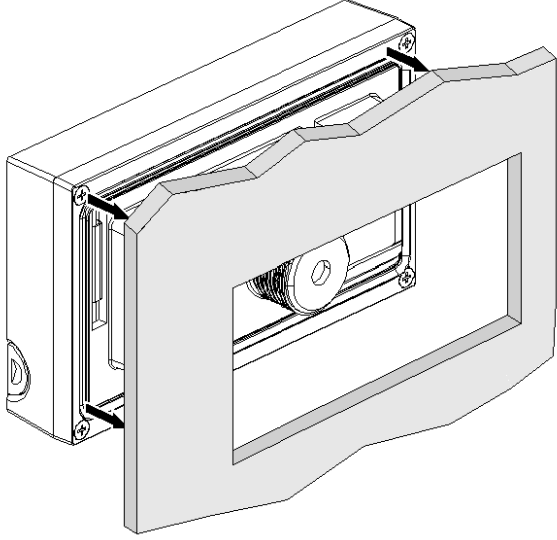
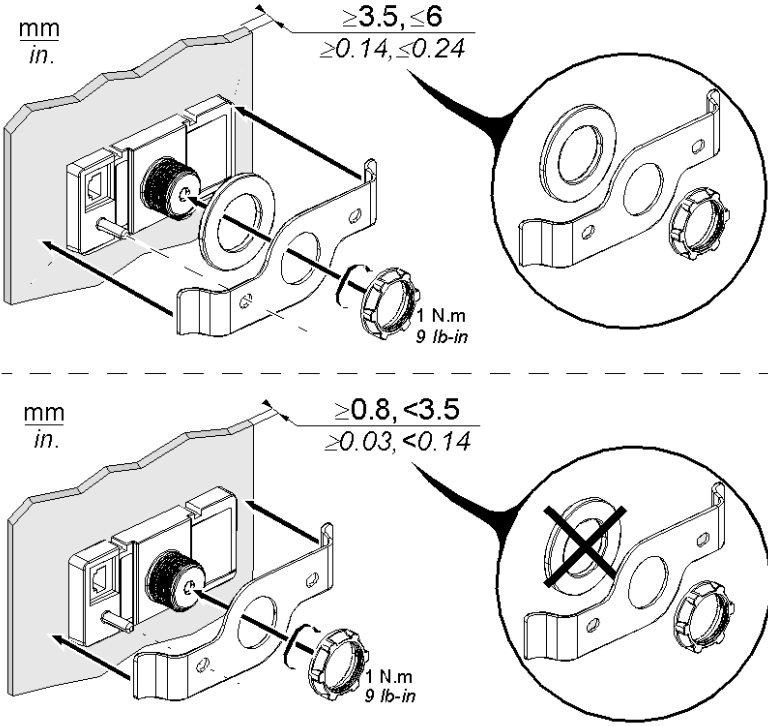
Step	Action
1	Cut an opening of 45 x 92 mm (1.77 x 3.6 in.) into the panel.
2	<p>Insert the unit into the panel cut, as shown below:</p> 
3	<p>As shown below, position the metallic washer only if the panel thickness is more than 3.5 mm (0.14 in.).</p> <p>Position the clamp in place, then insert the mounting nut and tighten. If the mounting nut is not correctly attached, the unit may shift or fall out of the panel:</p> <p>To open and lock the mounting nut, use the special tool No. ZB5 AZ905, if needed.</p> 

Mounting a Portable LTMCU

Overview

You may need to move your LTMCU from one place to another. To do so, use the kit (reference LTM9KCU) equipped with magnets, which turns the LTMCU into a portable device. Then, position the kit on a metallic surface.

This section describes how to mount an LTMCU into the kit and how to remove it.

LTM9KCU Kit Characteristics

- The kit consists of a casing, made of 2 symmetrical parts.
- No tools are required to mount or remove the LTMCU from the casing.
- 4 magnets, at the back of the kit, let you position the LTMCU on any metallic surface.
- For your convenience, you can move the kit together with its connection cable using the cable housing on the rear face of the casing.

Mounting the LTMCU into the LTM9KCU Kit

To mount the LTMCU into the kit:

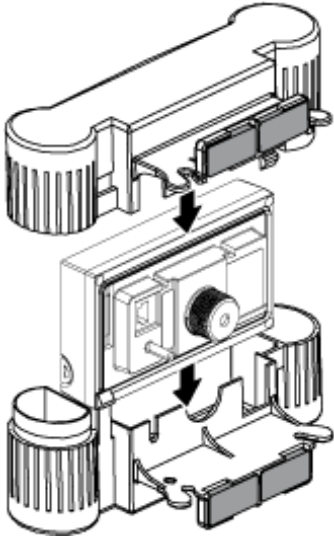
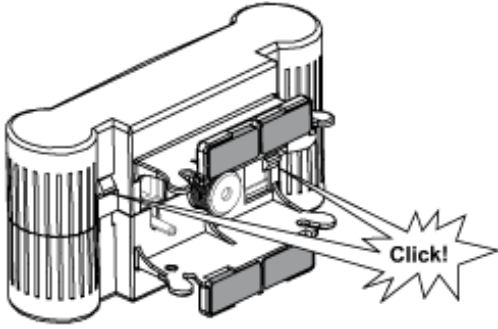
Step	Action
1	<p>Position the LTMCU between the 2 parts of the casing.</p> 
2	<p>Press the 2 parts until you hear a click.</p> 

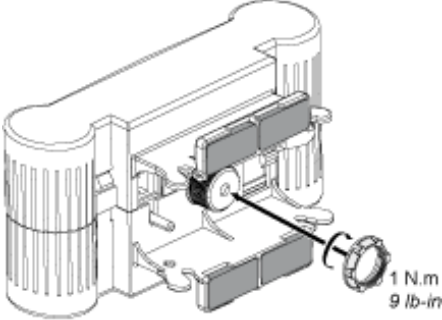
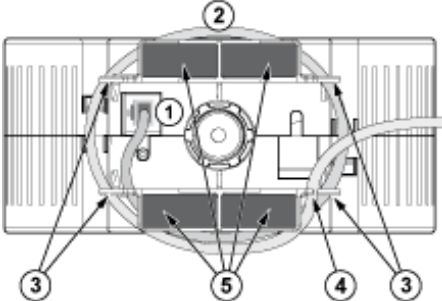
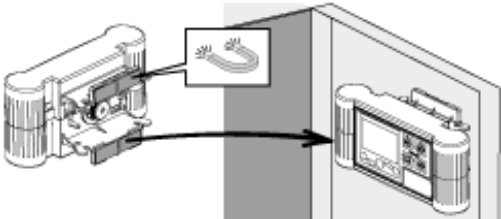
Step	Action
3	<p>On the rear face of the LTMCU, insert the mounting nut and tighten to 1 N•m (9 lb-in).</p>  <p>NOTE: Do not use the clamp which is part of the mounting fixation elements contained in the LTM CU box.</p>
4	<p>Connect the communication cable between the LTMCU and the LTMR controller on the RJ45 port.</p> <p>Wind the cable into the kit winding:</p> <ul style="list-style-type: none"> Start winding the cable anti-clockwise, ensuring the cable goes behind the 4 legs that are on the edge of the 4 magnets. On the last turn, use the slot on the lower right part of the casing to block the cable end. <p>NOTE: The cable housing allows for a 1 m (3.3 ft) maximum cable length.</p>  <p>1 RJ45 port 2 Communication cable 3 Legs (4) 4 Slot (to block the cable end) 5 Magnets</p>
5	<p>The magnets of the LTM9KCU kit enable the kit to be positioned on a metallic surface.</p> 

Removing the LTMCU from the LTM9KCU Kit

To remove the LTMCU from the kit:

Step	Action
1	Unwind the cable (if required), and disconnect it from the RJ45 port.
2	Unscrew the mounting nut.
3	Draw apart the two parts of the casing, and extract the LTMCU.

Connecting the LTMCU

Overview

After you have mounted the LTMCU, you must connect it to the HMI interface port (RJ45) on the LTMR controller, or on the LTM E expansion module. You can also connect a PC to the LTMCU front face port. This section describes how to connect the LTMCU to both the LTMR and a PC.

Wiring Rules

The following wiring rules must be respected in order to reduce disturbance on the behavior of the LTMCU due to EMC:

- Keep as large a distance as possible between the communication cable and the power and/or control cables (minimum 30 cm or 11.8 in.).
- Cross over different types of cables at right angles, if necessary.
- Do not bend or damage the cables. The minimum bending radius is 10 times the cable diameter.
- Avoid sharp angles of paths or passages of the cable.
- The cable shield must be connected to a protective ground at both ends.
- The connection of the cable shield must be as short as possible.
- Several shields can be connected together.
- Perform the grounding of the shield with a collar.
- Place the cable along the grounded plate around the withdrawable drawer.

NOTICE

UNINTENDED EQUIPMENT OPERATION

Use Schneider Electric standard cables.

Failure to follow these instructions can result in equipment damage.

Communication and Power Supply

The LTMCU connects to the LTMR controller via the RJ45 port at the rear of the unit (see [Connecting to the LTMR Controller](#), page 19). This connection is used to provide both the communication signals and the power supply.

Connecting Cables and RJ45 Pinout

To connect the LTMCU and the LTMR controller, use the specific cables LTM9CU10 and LTM9CU30.

The LTM CU RJ45 port pinout is shown below:

Front view

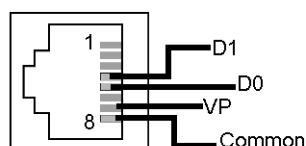

Pin no.	Signal	Description
1	Reserved	Do not connect
2	Reserved	Do not connect

Pin no.	Signal	Description
3	Reserved	Do not connect
4	D1 or D(B)	Communication between LTMCU and LTMR controller
5	D0 or D(A)	Communication between LTMCU and LTMR controller
6	Reserved	Do not connect
7	VP	+7 Vdc power supply provided by the LTMR controller
8	Common	Signal and power supply common

Connecting to the LTMR Controller

The diagrams below show the LTMCU connected to the LTMR controller, with and without the LTM E expansion module:

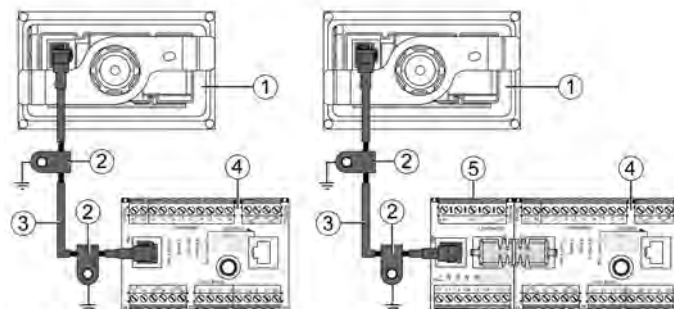

- 1 LTMCU Control Operator Unit
- 2 Grounding collar
- 3 LTM9CU HMI device connection cable
- 4 LTMR controller
- 5 LTM E expansion module

Power up

When the LTMCU has been connected to the LTMR controller, it powers up and performs a series of self-tests. During this time, the LCD display lights up and firmware version and language versions inside the LTMCU are displayed for a few seconds. After a successful connection, the backlight changes to the setting in LTMR and the main menu appears.

Connecting to a PC

You can connect a PC to the LTMCU via the RJ45 on the front face of the unit, as shown in the diagram below.

The diagrams below show the connections from a PC to the LTMCU and the LTMR controller, with and without the LTM E expansion module:

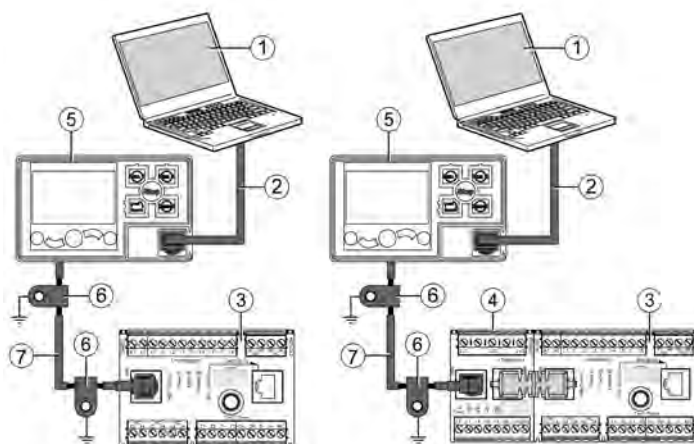

1 PC running SoMove with the TeSys T DTM

2 Cable kit TCSMCNAM3M002P

3 LTMR controller

4 LTM E expansion module

5 LTMCU Control Operator Unit

6 Grounding collar

7 LTM9CU•• HMI device connection cable

When the LTMCU is connected to a PC, the LTMCU becomes passive and cannot be used to visualize information.

Chapter 3

Language Management

Introduction

This chapter describes how to use the LTMCU Langtool language management software.

Use LTMCU Langtool to change the language stored in the LTMCU when you need the LTMCU to display other languages than those stored in the embedded dictionary.

Presentation of LTMCU Langtool

Overview

The LTMCU embedded dictionary can store up to 3 languages.

The default (factory) displayed language is English. You can change

- the 2 other stored languages,
- the English version.

To make these changes of language or version, you have to download language files to the LTMCU with a PC running the LTMCU Langtool language management software.

A language file contains a dictionary version of 1 language.

The LTMCU Langtool and language files can be downloaded from the Schneider Electric website (www.schneiderelectric.com).

LTMCU Langtool Software

LTMCU Langtool is a software dedicated to downloading language files to the LTMCU.

LTMCU Langtool:

- is a Microsoft® Windows® 2000/XP/7-based application,
- runs on a PC,
- enables the LTMCU to display information in several languages.

Language Files

The language files have a name structured as follows: LTMCU_ccV_XXXX.ini.

Example:

LTMCU_en0_1300.ini is the language file for the English (en) version.

Character	Description
cc	2-letter code of the language concerned (in lower case) following ISO 639 international standards
V	1 digit for the language variant (0 for basic language)
XXXX	4 digits for version of the language concerned

Downloading from the Website

The procedure below describes how to download to a PC:

- the LTMCU Langtool program file,
- language files.

Step	Action
1	Connect your PC to our website www.se.com .
2	In the Search field, type <code>TeSys T</code> .
3	Click Product Offer .
4	Click TeSys T .
5	On the TeSys T product offer page, click on Download / Documents & Softwares.
6	Click Software/Firmware .
7	Download to your PC: <ul style="list-style-type: none"> • the <i>LTMCU Langtool Software</i> • the <i>LTMCU_languages</i> file.

Processing the .zip file

The procedure below describes how to process the downloaded file so that LTMCU Langtool is ready for use:

Step	Action
1	In your Microsoft® Windows® file manager, unzip <i>landown_vxxx.zip</i> to a local directory using a decompression tool. The directory contains the root files including <i>Startup.exe</i> .
2	In your Microsoft® Windows® file manager, unzip <i>LTMCU_languages_xxx.zip</i> to a local directory using a decompression tool. The directory contains the available <i>*.ini</i> language files.

Using LTMCU Langtool

Process Description

The table below describes the steps to follow to download language files to the LTMCU with a PC running the LTMCU Langtool language management software.

Phase	Description
1	Connect the LTMCU to your PC: see Connecting the LTMCU , page 18. The LTM CU must be connected to the LTM R.
2	Start LTMCU Langtool.
3	Configure LTMCU Langtool.
4	Read data about languages stored in the LTMCU.
5	Select languages from the <i>Language</i> folder.
6	Download selected languages to the LTMCU.
7	Read again the language data to verify that the correct languages are properly stored in the LTMCU.
8	Close LTMCU Langtool.

NOTE: In this process, the *Language* folder refers to the folder located in the LTMCU Langtool local directory, see [Downloading from the Website](#), page 22.

Starting LTMCU Langtool

The procedure below describes how to start LTMCU Langtool.

Step	Action
1	Double-click the <i>Startup.exe</i> file from the LTMCU Langtool local directory.
2	Select the LTMCU firmware version and click Done .
3	Select a view language and click Done . This language will be used for the dialog boxes of LTMCU Langtool on your PC.

Configuring LTMCU Langtool

The procedure below describes how to configure LTMCU Langtool.

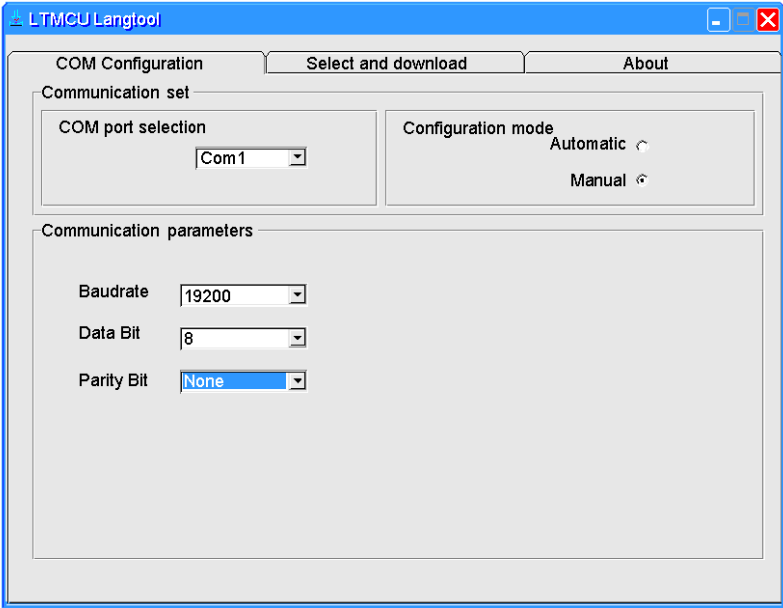
Step	Action						
1	<p>Select the COM Configuration tab.</p> 						
2	<p>Click the COM port selection arrow to select the PC communication port connected to the LTMCU.</p> <p>To know the virtual communication port assigned on the PC, when using the TCSMCNAM3M•••P cable:</p> <table border="1" data-bbox="320 1518 1461 1659"> <tbody> <tr> <td>1</td> <td>Open Device Manager in Windows</td> </tr> <tr> <td>2</td> <td>Expand Ports (COM & LPT)</td> </tr> <tr> <td>3</td> <td>Read the number of the assigned LTMCU virtual communication port.</td> </tr> </tbody> </table>	1	Open Device Manager in Windows	2	Expand Ports (COM & LPT)	3	Read the number of the assigned LTMCU virtual communication port.
1	Open Device Manager in Windows						
2	Expand Ports (COM & LPT)						
3	Read the number of the assigned LTMCU virtual communication port.						
3	<p>Select the Configuration mode:</p> <ul style="list-style-type: none"> • Automatic: the Communication parameters are set automatically and the configuration of LTMCU Langtool is then finished. • Manual: the communication parameters must be set. 						
4	<p>In Manual configuration mode only, set the communication parameters:</p> <ul style="list-style-type: none"> • Baudrate • Data Bit • Parity Bit 						
5	Click the Select and download tab to access the functionalities of LTMCU Langtool.						

LTCU Langtool Functionalities

The diagram below shows the **Select and download** tab of LTCU Langtool and the functionalities of the 3 areas in this tab.

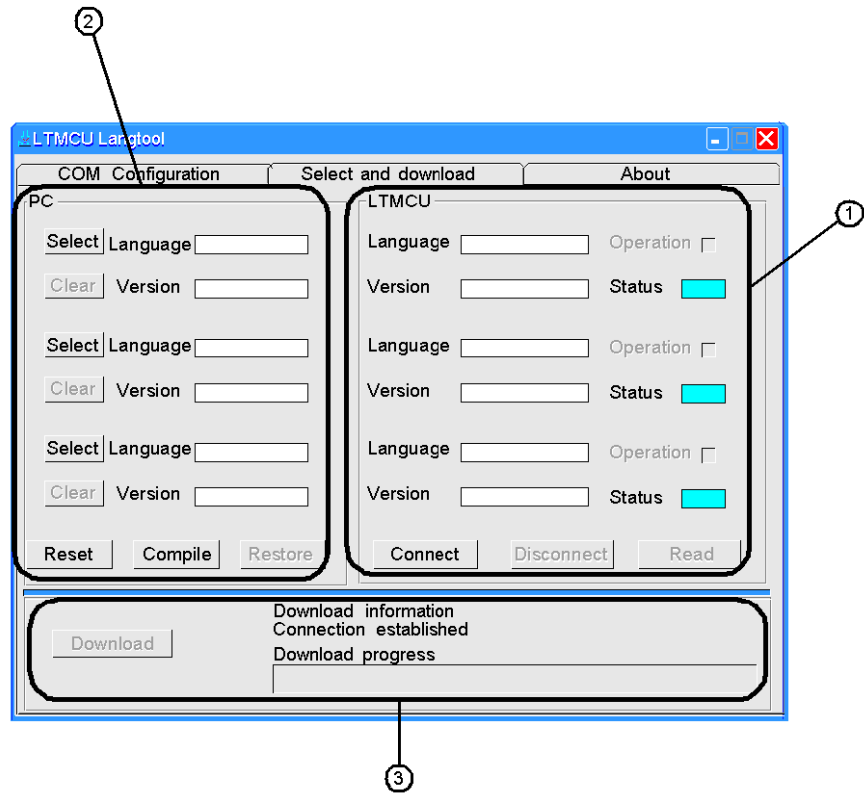

Area	Functionality
1	The LTCU area is dedicated to: <ul style="list-style-type: none"> • reading data about languages stored in the LTCU, • enabling and disabling languages stored in the LTCU.
2	The PC area is dedicated to: <ul style="list-style-type: none"> • select the languages to download to the LTCU from the LTCU Langtool <i>Language</i> folder.
3	The Download area is dedicated to: <ul style="list-style-type: none"> • downloading languages from your PC to the LTCU.

Reading Data about Languages





The procedure below describes how to read and display data on the languages stored in the LTCU. Use the **LTCU** area of the **Select and download** tab.

Step	Action	Result								
1	Select the Select and download tab.									
2	Click Connect .	Your PC can communicate with the LTMCU. An hour glass appears on the LTMCU display. It remains displayed until you click Disconnect in the LTMCU area.								
3	Click Read to display the data about the languages stored in the LTMCU.	The following data is displayed in a block for each language: <ul style="list-style-type: none"> • Language • Version • Status and Operation Example of a block: <div style="border: 1px solid #ccc; padding: 5px; margin: 10px 0;"> <table style="width: 100%; border-collapse: collapse;"> <tr> <td style="padding: 2px;">Language</td> <td style="padding: 2px;"><input type="text" value="English"/></td> <td style="padding: 2px;">Operation</td> <td style="padding: 2px;"><input checked="" type="checkbox"/></td> </tr> <tr> <td style="padding: 2px;">Version</td> <td style="padding: 2px;"><input type="text" value="1"/></td> <td style="padding: 2px;">Status</td> <td style="padding: 2px;"></td> </tr> </table> </div> 1 or 2 blocks, except the top block, may remain empty.	Language	<input type="text" value="English"/>	Operation	<input checked="" type="checkbox"/>	Version	<input type="text" value="1"/>	Status	
Language	<input type="text" value="English"/>	Operation	<input checked="" type="checkbox"/>							
Version	<input type="text" value="1"/>	Status								

Language Status and Operation



The table below describes:

- the 4 possible states for a language stored in the LTMCU,
- the use of the **Operation** checkbox.

Color	Status	Operation Checkbox
 green	Language is downloaded in the LTMCU and has been enabled (Operation checkbox checked).	Uncheck Operation to disable it.
 yellow	Language is downloaded in the LTMCU and has been disabled (Operation checkbox unchecked).	Check Operation to enable it.
 dark blue	Language has been downloaded in the LTMCU and has been removed after 7 check/uncheck actions on the Operation checkbox.	Operation checkbox not available. Download this language to the LTMCU if you want to enable it again.
 light blue	Language not properly downloaded in the LTMCU or no language in the LTMCU.	Operation checkbox not available. Download this language to the LTMCU if you want to enable it again.

Select Languages in the Language Folder

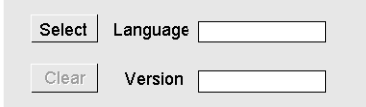
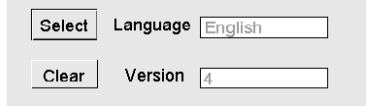
The procedure below describes how to select in the Language folder the languages to download to the LTMCU. Use the **PC** area of the **Select and download** tab.

Step	Action	Result
1	Select the Select and download tab.	The PC area is divided into 3 blocks.  Each block is dedicated to one of the languages you want to download into the LTMCU.
2	Click Select in a block.	The file folder opens.
3	Browse and open the right file in the <i>Language</i> folder. Language 1 must be English, but you can select the version. Language 2 and 3 may remain empty.	Your selection is displayed in the block: <ul style="list-style-type: none"> • Language • Version (language dictionaries are likely to evolve) 
4	Click Clear if you want to remove the selection in this block. Then go back to step 2.	
5	Once the languages are selected, click Compile to check the set of languages to download to the LTMCU.	Compiling lasts a few seconds until the "set complete" window displays. 
6	Click OK .	Your set of languages is ready to be downloaded to the LTMCU.
7	Perform one of the following actions: <ul style="list-style-type: none"> • download the set of languages, page 27. • click Reset and go back to step 2. • click Clear for any language and go back to step 2. If you accidentally cleared a language, click Restore to avoid returning to step 2. 	Selection of languages downloaded.

Example

The graphic shown below represents the **Select and download** tab of LTMCU Langtool.

In this example, a set of languages is ready to be downloaded to the LTMCU. The user has already:

- read (in the 3 blocks of the **LTMCU** area) data about languages stored in the LTMCU,
- selected (in the 3 blocks of the **PC** area) the languages to download to the LTMCU.

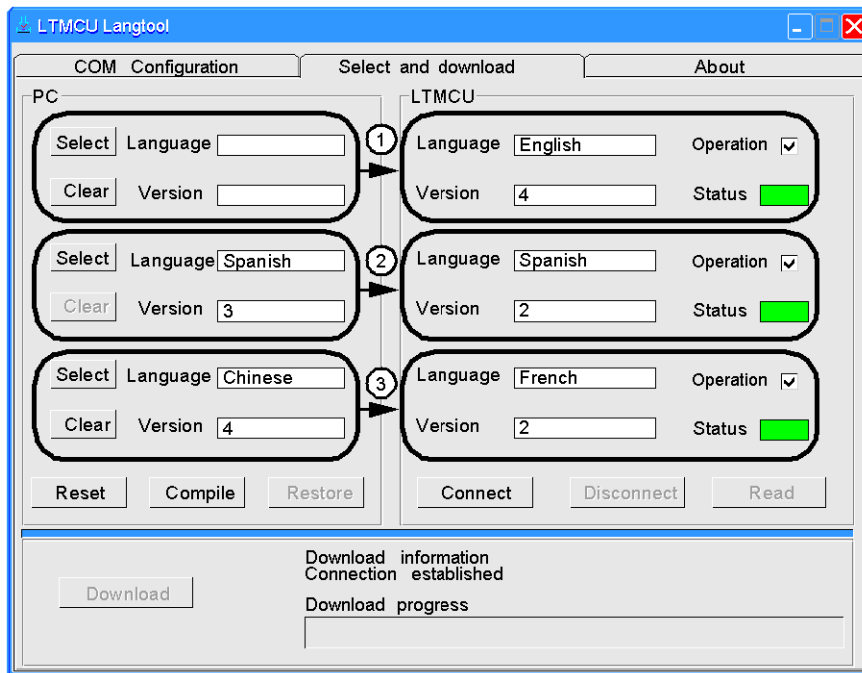

- 1 No change for English.
- 2 Spanish upgrade to a more recent version.
- 3 French version 2 replacement by Chinese version 4.

Download, Check and Close

The procedure below describes how to download the set of languages to the LTMCU. Use the **Download** and **LTMCU** areas.

Step	Action	Result
1	Click Download to transfer the language files.	When a block in the PC area is empty, the language stored in the LTMCU (opposite block in the LTMCU area) will not be changed. A popup window indicates that downloading is complete.
2	Click Read to check the languages stored in the LTMCU.	The status of downloaded languages must be green. If it is not the case, select again languages in the <i>Language</i> folder and download them again.
3	Click Disconnect to close the communication with the LTMCU.	You can disconnect your PC from the LTMCU.
4	Click  to quit LTMCU Langtool.	You are ready to select the language displayed by the LTMCU: see <i>Selecting the Language Displayed by the LTMCU</i> , page 43.

NOTE: Download time is approximately 5 minutes for each language.

Chapter 4

Using the LTMCU Control Operator Unit

Overview

This chapter describes how to use the LTMCU Control Operator Unit to configure and monitor LTM controller parameters.

LTMCU Physical Description

Front Face

The front face of the LTMCU is shown below:

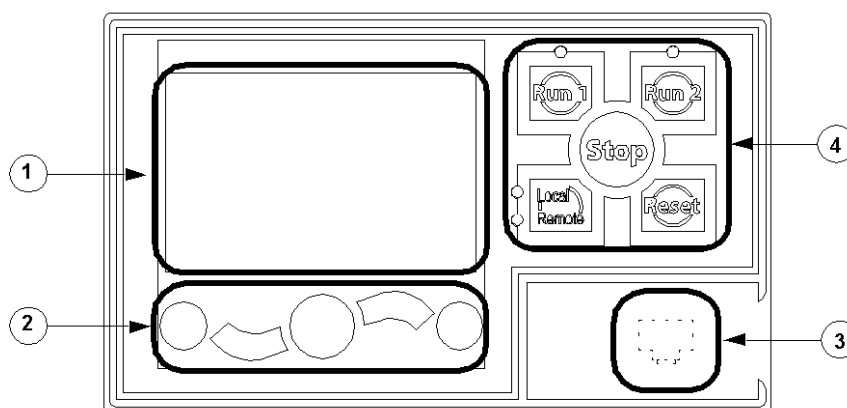

- 1 LCD display
- 2 Contextual navigation keys
- 3 Front face RJ45 port for PC connection (covered)
- 4 Local control interface, including 5 control keys and 4 LEDs

For a detailed description of:

- the LCD display and contextual navigation keys: see below.
- the control panel interface: see [Using the Local Control Interface](#), page 36.
- the RJ45 port: see [Connecting the LTMCU](#), page 18.

Navigation Keys

The LTMCU navigation keys are contextual, that is, their function depends on the associated icons shown on the LCD display. These icons change for different displays, so the navigation key functions also change.

The navigation keys can be used to:

- navigate menus and sub-menus,
- scroll within a value list,
- select a setting in a value list,
- exit a value list without making a selection,
- return to the main (first-level) menu,

- switch between manual and automatic presentation mode in Quick View display.

The diagram below shows an example of the different functions of each of the navigation keys associated with an icon on the LCD display:

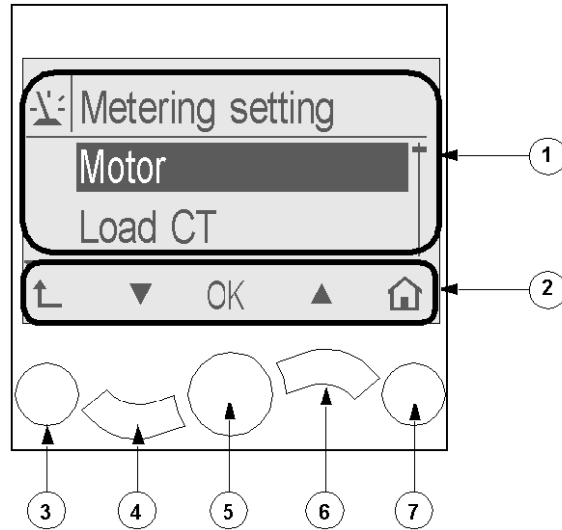



- 1 Information area of the LCD display
- 2 Contextual navigation icons area of the LCD display
- 3 Move up to the next higher-level menu
- 4 Move down to the next item in the menu
- 5 Select an item
- 6 Move up to the previous item in the menu
- 7 Return to the main menu

Contextual Navigation Icons

















The following table describes the icons used with the contextual navigation buttons on the LTMCU:

Icon	Description	Icon	Description
	Enables access to the main menu from a sub-menu or from Quick View		Enables access to Quick View from the main menu or a sub-menu
	Scroll down		Enables access to manual scroll mode (when Quick View is in automatic scroll mode)
	Scroll up		Enables access to automatic scroll mode (when Quick View is in manual scroll mode)
	Validates a setting or value and enables access to a sub-menu when a menu is selected		Used to increment a setting in menu mode

Icon	Description	Icon	Description
	Move up to the next higher-level menu		Used to decrement a setting in menu mode
	When a menu item is password-protected, this icon enables access to the Enter Password screen		

Information Icons

The following table describes the icons provided as information in the information area of the LCD display. They indicate, among others, the selected menu or parameter.

Icon	Description	Icon	Description
	Main menu		Indicates that the present display is Quick View
	Metering setting menu		Indicates that an alarm has occurred
	Protection setting menu		Indicates that an error has been detected
	Control setting menu		Information
	Services menu		Check box selected
	Language selection menu		Check box unselected
	Radio button selected		Item has been selected (for inclusion in Quick View display)
	Radio button unselected		LTMR in Configuration mode

LCD Displays

The LTM CU presents 3 different LCD displays:

LCD display	Functions
Menu	<ul style="list-style-type: none"> • Displaying and editing the configuration settings required for configuring the LTM R (metering, protection, control and services settings) • Displaying diagnostic and history data
Quick View	<ul style="list-style-type: none"> • Displaying real-time metering of pre-selected parameters by automatic or manual scrolling
Trips and Alarms	<ul style="list-style-type: none"> • Displaying the most recent trip or alarm

Each of these 3 displays is described in detail below.

LCD Display Settings

- The LCD display is continuously backlit.
- Contrast and Brightness are adjustable by using the Services menu.

Parameter Display

Overview

The LTMR parameters are contained in 2 different menu structures:

- the main menu and sub-menus
- the First setup menu

The navigation and sub-menu presentation are identical in the 2 menu structures. Each sub-menu consists of one or several levels of nested parameters.

The main menu appears

- on power-up of the LTMCU after the First setup menu settings have been saved, if no trips or alarms are detected, or
- by pressing the  button.

The main menu consists of 5 sub-menus: Metering setting, Protection setting, Control setting, Services, and Language. You can access each of these sub-menus from the main menu.

The First setup menu enables to set a limited number of configuration parameters of the LTMR, see [First Setup Menu](#), page 43.

Main Menu Display

The following diagram shows the elements in the main menu display:

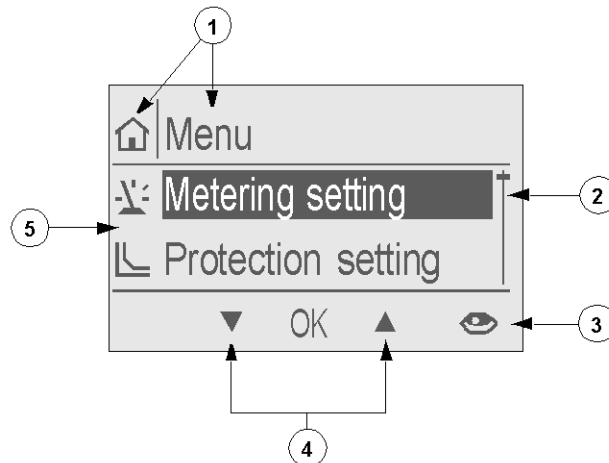

- 1 Main menu icon and title
- 2 Scroll bar, indicating level in the main menu
- 3 Short key to Quick View display (from main menu only)
- 4 Contextual menu navigation keys
- 5 Display area, with list of sub-menus identified by icon and title

Sub-Menu Display

The following diagram shows an example of a sub-menu display:

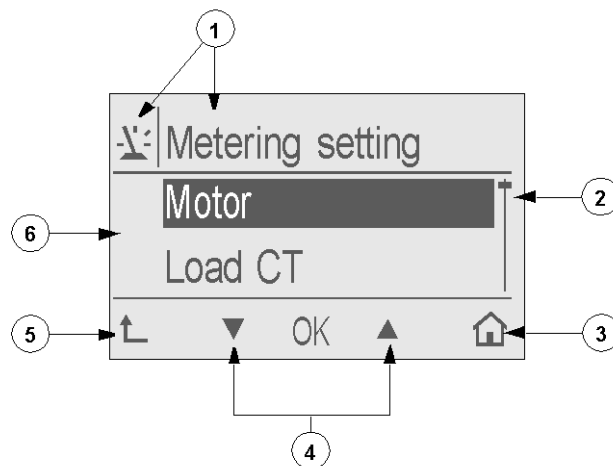

- 1 Menu icon and title
- 2 Scroll bar, indicating level in sub-menu
- 3 Short key to main menu
- 4 Contextual menu navigation keys
- 5 Return to higher-level menu key
- 6 Display area, with list of sub-menus

First Setup Display

The following diagram shows the First setup menu display:

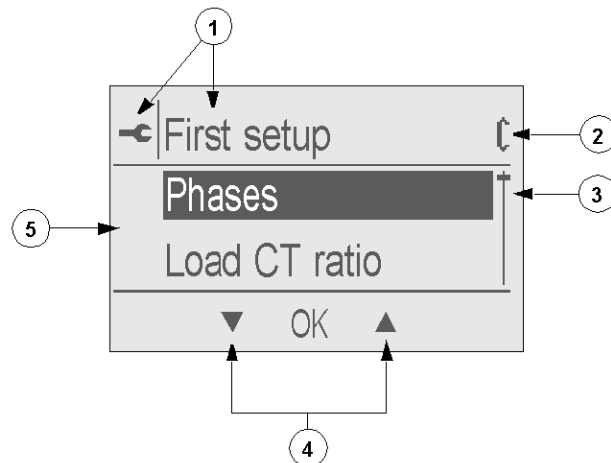



- 1 First setup menu icon and title
- 2 Configuration mode icon
- 3 Scroll bar, indicating level in the First setup menu
- 4 Contextual menu navigation keys
- 5 Display area with list of accessible parameters

Quick View Display

Overview

The Quick View display contains a scrolling list of dynamically changing values for pre-selected variables. Select the variables you want to display using the Services menu (see *Menu - Services*, page 51).

The Quick View is displayed:

- manually, by selecting  in the main menu,
- automatically, after the main menu has been displayed for 10 seconds with no key pressed, or
- by pressing  to close a trip or alarm display.

There are 2 types of Quick View display modes: automatic scroll mode and manual scroll mode. You can switch from one to the other by pressing contextual navigation keys.

Automatic Scroll Mode

The following screen shows a Quick View display in automatic scroll mode. In this mode, each variable is displayed for a few seconds at a time.

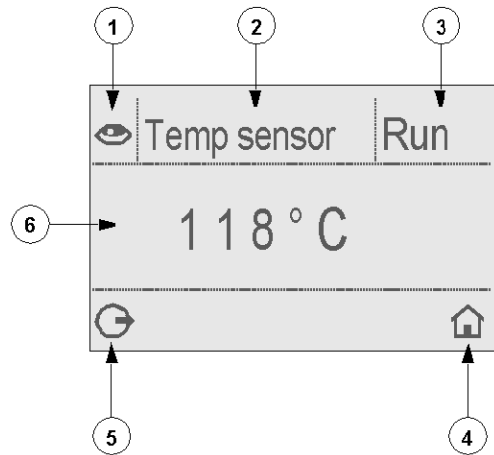

- 1 Quick View display icon
- 2 Name of the variable currently displayed
- 3 Motor state
- 4 Short key to main menu
- 5 Access to manual scroll mode by pressing the associated contextual navigation key
- 6 Value of the variable currently displayed

Manual Scroll Mode

The following screen shows a Quick View display in manual scroll mode. In this mode, you can scroll through the list of variables using the contextual navigation keys.

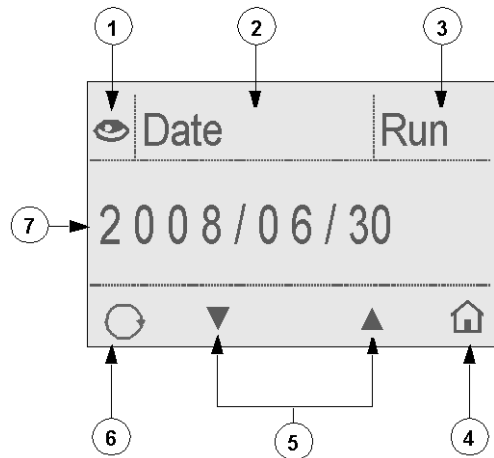

- 1 Quick View display icon
- 2 Name of the variable currently displayed
- 3 Motor state
- 4 Short key to main menu
- 5 Contextual navigation keys; pressing them scroll to the next or previous variable in the Quick View
- 6 Access to automatic scroll mode by pressing the associated contextual navigation key
- 7 Value of the variable currently displayed

Trips and Alarms Display

Overview

The Trips and Alarms Display contains a description of the most recent trip or alarm.

The Trips and Alarms display opens automatically upon a trip or alarm.

Trips or Alarms Display

The following diagram shows the elements in the Trips and Alarms display:

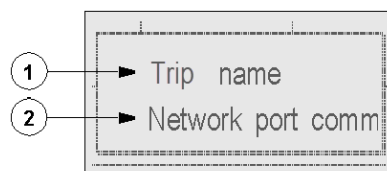

- 1 Text indicating whether a trip or alarm is displayed
- 2 Name of the trip or alarm currently displayed

Closing Trips and Alarms Display

The Trips and Alarms display is:

- automatically closed after acknowledgement of the trip or alarm, that is:
 - for an alarm: automatic acknowledgement when the associated real-time parameter value conditions are no longer satisfied
 - for a trip: acknowledgement on your initiative by operating a reset (LTM R or communication reset)
- temporarily closed on your initiative by pressing  and navigating the menus. After a few seconds, it will appear again.

Using the Local Control Interface

Overview

The Local Control Interface consists of 5 control keys and 4 LEDs. The control keys, if active, enable you to control the LTMR. Pressing a control key sends a signal to the LTMR to activate the associated function.

The 4 LEDs provide information about the LTMR state. These LEDs are driven from the LTMR and are not related to the LTMCU state.

Control Key Functions

The label on each of the control keys depends on the label set you have inserted (see Inserting the Local Control Interface Label, page 11).

⚠ WARNING

UNINTENDED EQUIPMENT OPERATION

Proper labeling of the control keys must be validated.

Failure to follow these instructions can result in death, serious injury, or equipment damage.

In order to explain the function of each control key, in the diagram below, the 5 control keys are labeled 1 to 5:

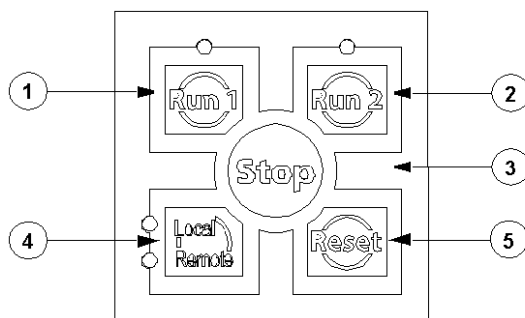

Control keys 1 to 3 are used to control LTM R outputs O.1 and O.2. The function of control keys 1 to 3 depends on the motor operating mode. The following table lists their functions for each operating mode:

Operating Mode	Assignment	Key 1	Key 2	Key 3
Overload	2-wire (maintained)	No action	No action	No action
	3-wire (impulse)			

Operating Mode	Assignment	Key 1	Key 2	Key 3
Independent	2-wire (maintained)	Control motor (O.1)	Control O.2	Stop motor (open O.1) and open O.2 while pressed
	3-wire (impulse)	Start motor (close O.1)	Close O.2	Stop motor (open O.1) and open O.2
Reverser	2-wire (maintained)	Forward run	Reverse run	Stop while pressed
	3-wire (impulse)	Start motor forward	Start motor reverse	Stop motor
Two-step	2-wire (maintained)	Control motor	No action	Stop while pressed
	3-wire (impulse)	Start motor	No action	Stop motor
Two-speed	2-wire (maintained)	Low speed control	High speed control	Stop while pressed
	3-wire (impulse)	Low speed start	High speed start	Stop motor

For more information about operating mode and output assignments, see the *TeSys® T LTMR Motor Management Controller User's Manual*.

The functions of control keys 4 and 5 are stable and do not depend on the operating mode. The following table describes the functions of control keys 4 and 5:

Control Key	Description
Key 4	Switch between local and remote mode.
Key 5	Reset the LTMR controller and clear all detected errors that can be reset.

Active/Inactive Control Keys

Control keys 1 to 5 are active or inactive according to the selected active control source. The following table describes the state of control keys 1 to 5 for each case:

Control Key	The LTMCU channel...	
	is the active control source	is not the active control source
1	Active	Inactive
2	Active	Inactive
3	Active	<ul style="list-style-type: none"> 2-wire: inactive 3-wire: active if the value of the Stop HMI Disable parameter = 0 (Stop HMI key is enabled)
4	Depending on the value of the Control Remote Local Buttons Enable parameter: <ul style="list-style-type: none"> parameter = 0 (disable): key is inactive parameter = 1 (enable): key is active 	
5	Active	

LEDs

In the diagram below, the 4 control LEDs are labeled A - D:

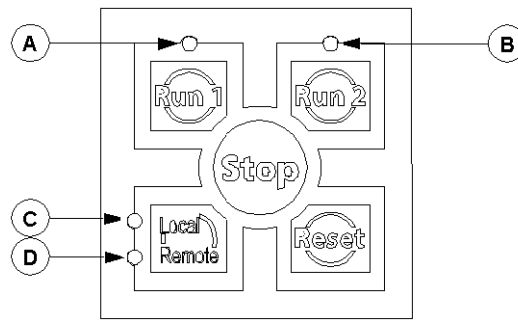

The following table describes each of the 4 LEDs:

LED	When active, indicates that:	Color
A	Output O.1 is active (see the functional description for control key 1 above)	Red or green
B	Output O.2 is active (see the functional description for control key 2 above)	Red or green
C	The active control source is the local source	Amber
D	The active control source is the remote source	Amber

You can choose whether the LEDs A and B are red or green when active by setting the Run LED color parameter in the Services sub-menu. See *HMI Setting*, page 52.

Active Control Source

The LTMCU can be configured as the local or remote active control source.

- The LTMCU is the active local control source when the parameter Control local channel setting is set to HMI.
- The LTMCU is the active remote control source when the parameter Control remote channel setting is set to HMI.
- The key 4 allows to switch between local and remote control mode if the logic input I.6 is **ON** and the parameter HMI remote local buttons enable is set to **Yes**.

The parameters are available from the sub-menu Control Settings / Remote/Local. See *Remote/Local*, page 50 in the Control Setting Menu.

The table below indicates if the keys are active or not depending on the LTMCU active source status and the color of the Local / Remote LEDs:

If LTMCU is...	and if...	Then the keys are...
the local active source	LED C is ON (amber)	active
	LED D is ON (amber)	inactive
the remote active source	LED C is ON (amber)	inactive
	LED D is ON (amber)	active

Example

The following example explains the meaning of LED C and D state to know whether keys 1 and 2 are active or not.

If the 2 following conditions are satisfied:

- Control local channel setting parameter is set to HMI (in this example: HMI = LTMCU)

- I.6 input is active (for example in case of a strap between C and I.6 inputs on the LTMR plug-in terminal)

Then the HMI is the local control channel and keys 1 and 2 are active / inactive according to LED C and D state:

- LED C **ON** and LED D **OFF** means that the LTMCU is the active control source: keys 1 and 2 are active
- LED C **OFF** and LED D **ON** means that the LTMCU is not the active control source: keys 1 and 2 are inactive.

Navigating the Menu Structure



Overview

When the LTMCU is powered up:

- The First setup menu is displayed when LTMR commissioning was not done.
- The trip and alarm display is executed if the LTMR is in a trip or alarm condition.
- The Quick View is displayed in other cases. Back to main menu by  button.

Navigating Menus and Sub-menus

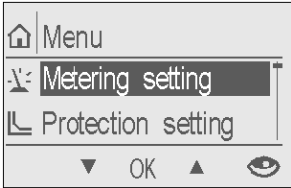
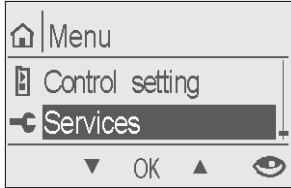
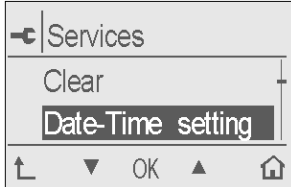
The example below shows how to navigate the menu structure to display the date and time settings:

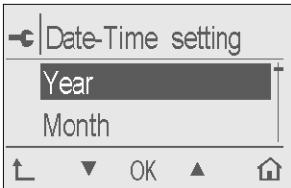
Step	Description	Screen Display
1	If necessary, press  on the right to access the main menu (shown here). Press ▼ to scroll down to other menu choices.	
2	When the Services menu is highlighted, press OK to enter the Services menu.	
3	Press ▼ to select the Date-Time setting sub-menu and press OK to enter.	
4	You can now access the date and time settings. You can also press  to return to the Services menu, or press  on the right to return to the main menu.	

Editing Values

Overview

You can use the **▼**, **▲**, and **OK** keys to select and edit settings. There are 2 ways to edit setting values using the LTMCU:

- Select an item in a value list
- Edit a numerical value, one digit at a time

NOTE: Some settings, although expressed as numerical values, are selected in the same way as an item in a value list. For example, a setting with a value that is expressed in units, but can be incremented or decremented only by tens or hundreds of units, is edited by scrolling through a value list.

The LTMCU enables the configuration and modification of 2 types of parameters:

- the main parameters of the LTMR through the configuration mode,
- the other parameters.

Editing any value requires familiarity with the LTMCU menu structure, and general navigation principles.

- For information on menu navigation, see *Navigating the Menu Structure*, page 39.
- For information on the menu structure, see *Main Menu*, page 44.



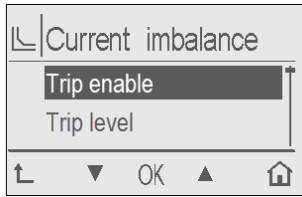
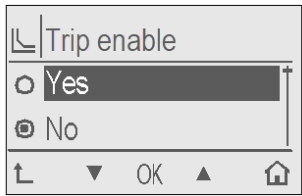
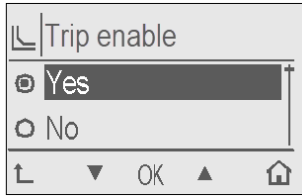
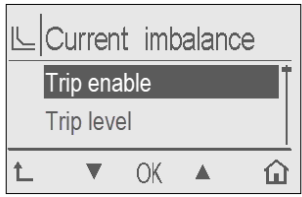

Selecting Values in a List

The following example describes how to set the Current phase imbalance trip enable parameter by selecting the Yes value in a list:

Step	Description	Screen display
1	Select Protection settings - Current - Current imbalance. Use ▼ or ▲ to select Trip enable and press OK .	
2	Select Yes and press OK .	
3	The radio button beside the selection indicates the parameter's saved setting.	
4	After a few seconds, the display automatically returns to the Current imbalance menu. You can then navigate to another parameter to continue configuration or return to the main menu.	

Editing Numerical Values

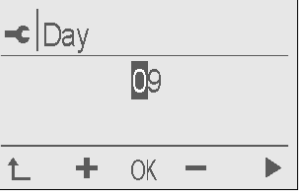
The following example describes setting the date and time parameters by editing numerical values:

Step	Description	Screen display
1	Select Services - Date-Time setting to navigate to the date and time parameters, then press OK .	
2	Use ▼ or ▲ to select Day and press OK .	
3	Use + or - to increase or decrease the selected value.	
4	Press ▶ to select the second digit for editing, use + or - to increase or decrease the selected value, then press OK to save the setting.	
5	The display then automatically returns to the Date and Time menu.	

Configuration Mode

The LTMCU is in configuration mode:

- by default in the First setup menu, see [First Setup Menu](#), page 43, or
- from the main menu, select Services menu then Config, Enter config.

When the LTMR is in configuration mode, the  icon is displayed in the right top corner of the information area:

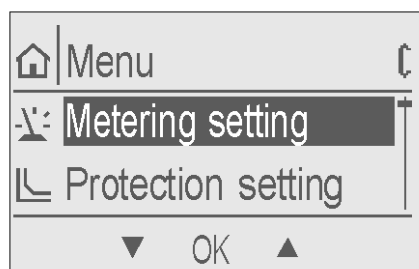

The procedure below describes how to edit parameters in configuration mode:

Step	Action
1	In configuration mode, edit parameters.
2	When all parameters are set, the last menu item to appear is End config: press OK to validate.
3	Select Yes to save the configuration or No to cancel changes.

NOTE: In configuration mode, access to the Quick View display is not proposed.

For more information on the configurable parameters in configuration mode only, see the TeSys® T LTMR *Motor Management Controller User's Manuals*.

Password Access

Overview

You can set a password for the LTMCU to limit access to configuration of LTMR controller parameters to authorized personnel. When a password has been set, other users can view the information displayed by the LTMCU, but cannot edit parameter values.

Entering a Password

The LTMCU password must be an integer from 0000 to 9999.

The process of entering a password is similar to editing a numerical setting.

Step	Description
1	Select Services - HMI setting - Password - Change passwd to navigate to the HMI Keypad Password parameter.
2	Press OK to step into the Password setting. The value 0000 appears by default, and is not necessarily the active password.
3	Press OK again to select the first (left-most) digit for editing.
4	Use + or - to increase or decrease the first digit value.
5	Press ▶ to move to the second digit for editing. Use + or - to increase or decrease the second digit value. Note: Other digits remain hidden and are displayed as an asterisk.
6	Press ▶ to move to the third digit for editing. Use + or - to increase or decrease the third digit value.
7	Press ▶ to move to the fourth digit for editing. Use + or - to increase or decrease the fourth digit value.
8	Press OK to complete the entry of the new password. The LCD displays the screen for confirming the new password.
9	Repeat steps 3 through 8. When the new password is confirmed, the LCD returns to the previous (higher) level screen.

Authorizing Parameters Editing

When password protection is enabled, editing a parameter setting requires entering the password.

The process of entering a password is similar to editing a numerical setting.

Step	Description
1	Press contextual menu navigation keys to navigate to the parameter to edit.
2	Press  . The screen to enter the password is displayed.

Step	Description
3	Press OK to select the first (left-most) digit for editing.
4	Use + or - to increase or decrease the first digit value.
5	Press ▶ to move to the second digit for editing. Use + or - to increase or decrease the second digit value. Note: Other digits remain hidden and displayed as an asterisk.
6	Press ▶ to move to the third digit for editing. Use + or - to increase or decrease the third digit value.
7	Press ▶ to move to the fourth digit for editing. Use + or - to increase or decrease the fourth digit value.
8	Press OK to complete the entry of the password. When the password is confirmed, you can edit the parameter value.

Password Activation/Deactivation

Enter a password value from 0001 to 9999 to enable password protection.



Enter a password value of 0000 to disable password protection.

Password protection is disabled by default.

Selecting the Language Displayed by the LTMCU

Procedure

The procedure below enables you to select one language stored in the LTMCU memory:

Step	Action
1	Press  to return to the LTMCU main menu.
2	Display the Language sub-menu by: <ul style="list-style-type: none"> • either navigating the menu structure: Menu/Services/HMI setting/Language, • or select the  Language sub-menu from the main menu.
3	Select a language among the list of stored languages. Up to 3 stored languages are available.
4	Use the ▼ and ▲ keys to select a language among the list of stored languages. Press OK .

The LTMCU will now display the language you have selected.

NOTE: If you want to display another language, you can download other languages by using a PC running the LTMCU Langtool language management software: see [Language Management](#), page 21.

First Setup Menu

Definition

The First setup menu displays as follows:

- On power-up, if the connected LTMR is not configured (first power-up or after executing a Clear all command in the Services menu), the parameters must be configured according to the connected LTMR and the Controller system config required to get the LTMCU operational.
- On subsequent power-ups after selecting Config in the Services menu, see Menu - Services, page 51.

The LTMCU is in configuration mode in the First setup menu, see Sub-Menu Display, page 32.

First Setup Parameters

The following editable parameters need to be configured before the LTMR can be used. Note that some parameters in the following list may not be available depending on the configuration selections you make:

Level 1	Level 2	Level 3	Parameter name	
First setup	Phases		Motor phases	
	Nominal voltage		Motor nominal voltage	
	Nominal power		Motor nominal power	
	Load CT ratio			Load CT ratio
		Primary		Load CT primary
		Secondary		Load CT secondary
	CT multi passes		Load CT multiple passes	
	Operating mode		Motor operating mode	
	Two-step level ⁽¹⁾		Motor step 1 to 2 threshold	
	Two-step time		Motor step 1 to 2 timeout	
	Star-delta		Motor star-delta	
	Trip type		Thermal overload mode	
	Trip class		Motor trip class	
	FLC1 or OC1 ⁽²⁾		Motor full load current ratio	
	FLC2 or OC2 ⁽³⁾		Motor high speed full load current ratio	
	Definite O-Time		Thermal overload trip definite timeout	
	Local channel		Control local channel setting	
	Network protocol ⁽⁴⁾		Communication protocol	
Language		HMI language setting		
End config		Controller system config required		
(1) Depending on motor operating mode				
(2) Depending on trip type				
(3) Depending on trip type and motor operating mode				
(4) For LTMR Ethernet TCP/IP only				

Main Menu

Overview

The LTMCU's main menu gives access to sub-menus which enable access to the parameters required to configure the LTMR. The settings sub-menus are described below:

Sub-menu	Contains	See...
Metering setting	Configurable settings for Motor, Load CT, and Ground CT parameters.	Menu - Metering Setting, page 45
Protection setting	Configurable settings for Thermal, Voltage, Current, Power and Voltage Dip Management parameters.	Menu - Protection Setting, page 46
Control setting	Configurable settings for fallback, remote/local mode, transfer mode, detected trip reset, diagnostics, motor and contactor parameters.	Menu - Control Setting, page 49
Services	Configurable settings for HMI, network, maintenance and detected trip history as well as read-only parameters for product ID. This menu also enables you to set parameters for Quick View.	Menu - Services, page 51
Language	Available languages for the LTMCU display. The default language is English.	Language Management, page 21

NOTE: Not all the parameters listed in the following pages will appear in the LTMCU sub-menus. The parameters available depend on the type and configuration of the system.

Menu - Metering Setting

Metering Setting Menu

The Metering setting menu contains the following sub-menus:

Level 1	Level 2	Level 3
Menu	Metering setting	Motor
		Load CT
		Ground CT
		AC inputs

Motor

The Motor sub-menu contains the following editable parameters:

Level 3	Level 4	Parameter Name
Motor	Phases	Motor phases
	Nominal voltage	Motor nominal voltage
	Nominal power	Motor nominal power
	Temp sensor	Motor temperature sensor type

Load CT

The Load CT sub-menu contains the following editable parameters:

Level 3	Level 4	Level 5	Parameter Name
Load CT	Load CT ratio		Load CT ratio
		Primary	Load CT primary (external CT and specific ratio)
		Secondary	Load CT secondary (external CT and specific ratio)
	CT multi passes		Load CT multiple passes

Ground CT

The Ground CT sub-menu contains the following editable parameters:

Level 3	Level 4	Level 5	Parameter Name
Ground CT	Ground CT ratio		Ground current trip configuration
		Primary	Ground CT primary
		Secondary	Ground CT secondary

AC inputs

The AC inputs sub-menu contains the following editable parameters:

Level 3	Parameter Name
AC inputs	Controller AC logic inputs configuration

Menu - Protection Setting

Protection Settings

The Protection setting menu contains the following sub-menus:

Level 1	Level 2	Level 3
Menu	Protection setting	Thermal
		Current
		Voltage
		Power
		Voltage dip mngt

Thermal

The Thermal sub-menu contains the following editable parameters:

Level 3	Level 4	Level 5	Parameter Name
Thermal	Thermal overload	Trip type	Thermal overload mode
		Trip class	Motor trip class
		Auxiliary fan	Motor auxiliary fan cooled
		Trip enable	Thermal overload trip enable
		FLC1 or OC1	Motor full load current ratio, FLC1
		FLC2 or OC2	Motor high speed full load current ratio, FLC2
		Reset level	Thermal overload trip reset threshold
		Definite O-Time	Thermal overload trip definite timeout
		Alarm enable	Thermal overload alarm enable
		Alarm level	Thermal overload alarm threshold
		Temp sensor	Trip enable
	Trip level		Motor temperature sensor trip threshold
	Trip level		Motor temperature sensor trip threshold degree
	Alarm enable		Motor temperature sensor alarm enable

Level 3	Level 4	Level 5	Parameter Name
		Alarm level	Motor temperature sensor alarm threshold
		Alarm level	Motor temperature sensor alarm threshold degree

Current

The Current sub-menu contains the following editable parameters:

Level 3	Level 4	Level 5	Parameter Name
Current	Current imbalance	Trip enable	Current phase imbalance frip enable
		Trip level	Current phase imbalance trip threshold
		Trip time starting	Current phase imbalance trip timeout starting
		Trip time running	Current phase imbalance trip timeout running
		Alarm enable	Current phase imbalance alarm enable
		Alarm level	Current phase imbalance alarm threshold
	Current ph loss	Trip enable	Current phase loss trip enable
		Trip time	Current phase loss timeout
		Alarm enable	Current phase loss alarm enable
	Current ph rev	Phase sequence	Motor phases sequence
		Trip enable	Current phase reversal trip enable
	Long start	Trip enable	Long start trip enable
		Trip level	Long start trip threshold
		Trip time	Long start trip timeout
	Jam	Trip enable	Jam Trip enable
		Trip level	Jam trip threshold
		Trip time	Jam trip timeout
		Alarm enable	Jam alarm enable
		Alarm level	Jam alarm threshold
	Undercurrent	Trip enable	Undercurrent trip enable
		Trip level	Undercurrent trip threshold
		Trip time	Undercurrent trip timeout
		Alarm enable	Undercurrent alarm enable
		Alarm level	Undercurrent alarm threshold
	Overcurrent	Trip enable	Overcurrent trip enable
		Trip level	Overcurrent trip threshold
		Trip time	Overcurrent trip timeout
		Alarm enable	Overcurrent alarm enable
		Alarm level	Overcurrent alarm threshold
	Current (continued)	Ground current	Start disable
Trip enable			Ground current trip enable
Trip level			Internal ground current trip threshold
Trip level			External ground current trip threshold
Trip time			Internal ground current trip timeout
Trip time			External ground current trip timeout
Alarm enable			Ground current alarm enable

Level 3	Level 4	Level 5	Parameter Name
		Alarm level	Internal ground current alarm threshold
		Alarm level	External ground current alarm threshold

Voltage

The Voltage sub-menu contains the following editable parameters:

Level 3	Level 4	Level 5	Parameter Name
Voltage	Voltage imbalance	Trip enable	Voltage phase imbalance trip enable
		Trip level	Voltage phase imbalance trip threshold
		Trip time starting	Voltage phase imbalance trip timeout starting
		Trip time running	Voltage phase imbalance trip timeout running
		Alarm enable	Voltage phase imbalance alarm enable
		Alarm level	Voltage phase imbalance alarm threshold
	Voltage ph loss	Trip enable	Voltage phase loss trip enable
		Trip time	Voltage phase loss trip timeout
		Alarm enable	Voltage phase loss alarm enable
	Voltage ph rev	Trip enable	Voltage phase reversal trip enable
	Undervoltage	Trip enable	Undervoltage trip enable
		Trip level	Undervoltage trip threshold
		Trip time	Undervoltage trip timeout
		Alarm enable	Undervoltage alarm enable
		Alarm level	Undervoltage alarm threshold
	Overvoltage	Trip enable	Overvoltage trip enable
		Trip level	Overvoltage trip threshold
		Trip time	Overvoltage trip timeout
		Alarm enable	Overvoltage alarm enable
		Alarm level	Overvoltage alarm threshold

Power

The Power sub-menu contains the following editable parameters:

Level 3	Level 4	Level 5	Parameter Name
Power	Underpower	Trip enable	Underpower trip enable
		Trip level	Underpower trip threshold
		Trip time	Underpower trip timeout
		Alarm enable	Underpower alarm enable
		Alarm level	Underpower alarm threshold
	Overpower	Trip enable	Overpower trip enable
		Trip level	Overpower trip threshold
		Trip time	Overpower trip timeout
		Alarm enable	Overpower alarm enable
		Alarm level	Overpower alarm threshold

Level 3	Level 4	Level 5	Parameter Name
	Under power fact	Trip enable	Under power factor trip enable
		Trip level	Under power factor trip threshold
		Trip time	Under power factor trip timeout
		Alarm enable	Under power factor alarm enable
		Alarm level	Under power factor alarm threshold
	Over power fact	Trip enable	Over power factor trip enable
		Trip level	Over power factor trip threshold
		Trip time	Over power factor trip timeout
		Alarm enable	Over power factor alarm enable
		Alarm level	Over power factor alarm threshold

Voltage Dip Management

The Voltage dip mngt sub-menu contains the following editable parameters:

Level 3	Level 4	Parameter Name
Voltage dip mngt	Function	Voltage dip mode
	Loss level	Voltage dip threshold
	Loss time	Load shedding timeout
	Immediate time	Auto restart immediate timeout
	Delayed time	Auto restart delayed timeout
	Restart level	Voltage dip restart threshold
	Restart time	Voltage dip restart timeout

Menu - Control Setting

Control Setting Menu

The Control setting menu contains the following sub-menus:

Level 1	Level 2	Level 3
Menu	Control setting	Fallback
		Remote / Local
		Stop enable
		LI3 assignment
		Diagnostics
		Trips reset
		Motor
		Contactore

Fallback

The Fallback sub-menu contains the following editable parameters:

Level 3	Level 4	Parameter Name
Fallback	HMI fallback	HMI port fallback setting
	Network fallback	Network port fallback setting

Remote/Local

The Remote / Local sub-menu contains the following editable parameters:

Level 3	Level 4	Parameter Name
Remote/Local	Remote channel	Control remote channel setting
	Local channel	Control local channel setting
	HMI R/L enable	HMI remote local buttons enable
	Power-up mode	HMI remote local default mode
	Transfer mode	Control transfer mode

Stop enable

The Stop enable sub-menu contains the following editable parameters:

Level 3	Level 4	Parameter Name
Stop enable	Terminals	Stop terminal strip disable
	HMI	Stop HMI disable

LI3 assignment

The LI3 assignment sub-menu contains the following editable parameter:

Level 3	Parameter Name
LI3 assignment	Logic input 3 external ready enable

Diagnostics

The Diagnostics sub-menu contains the following editable parameters:

Level 3	Level 4	Level 5	Parameter Name
Diagnostics	Wiring trip	Trip enable	Wiring trip enable
	On-Off diagnostic	Trip enable	Diagnostic trip enable
		Alarm enable	Diagnostic alarm enable

Trip Reset

The Trip reset sub-menu contains the following editable parameters:

Level 3	Level 4	Level 5	Parameter Name
Trip reset	Reset mode	-	Trip reset mode
	Autoreset group 1	Reset number	Auto-reset attempts group 1 setting
		Reset time	Auto-reset group 1 timeout
	Autoreset group 2	Reset number	Auto-reset attempts group 2 setting

Level 3	Level 4	Level 5	Parameter Name
		Reset time	Auto-reset group 2 timeout
	Autoreset group 3	Reset number	Auto-reset attempts group 3 setting
		Reset time	Auto reset group 3 timeout

Motor

The Motor sub-menu contains the following editable parameters:

Level 3	Level 4	Parameter Name
Motor	Operating Mode	Motor operating mode
	Rapid cycle time	Rapid cycle lockout timeout
	Direct transition	Control direct transition
	Transition time	Motor transition timeout
	Two-step level	Motor step 1 to 2 threshold
	Two-step time	Motor step 1 to 2 timeout
	Star-delta	Motor star-delta

Contactactor

The Contactactor sub-menu contains the following editable parameters:

Level 3	Level 4	Parameter Name
Contactactor	Contactactor rating	Contactactor rating

Menu - Services

Services Menu

The Services menu contains the following sub-menus:

Level 1	Level 2	Level 3
Menu	Services	Date-Time setting
		HMI setting
		Network
		History
		Config
		Settings
		Product ID
		Self-test
	Clear	

The Services sub-menus are described below.

Date-Time Setting

The Date-Time setting sub-menu contains the following editable parameters:

Level 3	Level 4	Parameter Name
Date-Time setting	Year	Date and time setting
	Month	
	Day	
	Hour	
	Minutes	
	Seconds	

HMI Setting

The HMI Setting sub-menu contains the following editable parameters:

Level 3	Level 4	Parameter Name	
HMI setting	Language	HMI language setting	
	Contrast	HMI display contrast setting	
	Brightness	HMI display brightness setting	
	Run LED color	HMI motor status LED color	
	Degree unit	Motor temperature sensor display degree CF	
Level 3	Level 4	Level 5	Parameter Name
HMI setting (continued)	Quick View	Motor status	HMI display motor status enable
		Date	HMI display date enable
		Time	HMI display time enable
		Last start	HMI display start statistics enable
		Thermal capacity	HMI display thermal capacity level enable
		Remain th cap	HMI display thermal capacity remaining enable
		Time to trip	HMI display time to trip enable
		Average voltage	HMI display average voltage enable
		L1-L2 voltage	HMI display L1-L2 voltage enable
		L2-L3 voltage	HMI display L2-L3 voltage enable
		L3-L1 voltage	HMI display L3-L1 voltage enable
		Voltage imbalance	HMI display voltage phase imbalance enable
		Average current	HMI display average current enable
		L1 current	HMI display L1 current enable
		L2 current	HMI display L2 current enable
		L3 current	HMI display L3 current enable
		Avg current in%	HMI display average current ratio enable
		L1 current in%	HMI display L1 current ratio enable
		L2 current in%	HMI display L2 current ratio enable
		L3 current in%	HMI display L3 current ratio enable
		Current imbalance	HMI display current phase imbalance enable
		Ground current	HMI display ground current enable
		Active power	HMI Display active power enable
		Reactive power	HMI display reactive power enable
Power Wh	HMI Display power consumption enable		
Power factor	HMI display power factor enable		

Level 3	Level 4	Level 5	Level 6	Parameter Name
		Frequency		HMI display frequency enable
		Temp sensor		HMI motor temperature sensor enable
		Operating time		HMI display operating time enable
		Starts per hour		HMI display starts per hour enable
		I/O status		HMI display I/O status enable
		Control mode		HMI display control mode enable
Level 3	Level 4	Level 5	Level 6	Parameter Name
HMI Setting (continued)	Password	Change password		HMI keypad password
	HMI comm	Baud rate		HMI port baud rate setting
		Parity		HMI port parity setting
		Comm Loss	Trip enable	HMI port trip enable
			Alarm enable	HMI port alarm enable

Network (Modbus, Profibus, CANopen, DeviceNet)

The Network sub-menu contains the following parameters:

Level 3	Level 4	Level 5	Level 6	Parameter Name	
Network	Network settings	Address		Network port address setting	
		Baud rate ⁽¹⁾		Network port baud rate setting	
		Parity ⁽²⁾		Network port parity setting	
		Endian		Network port endian setting	
		Comm loss	Trip enable		Network port trip enable
			Alarm enable		Network port alarm enable
			Network timeout ⁽¹⁾		Network port comm loss timeout
		Device Status	Baud rate ⁽¹⁾		Network port baud rate
			Parity ⁽²⁾		Network port parity
	Address		Network port address setting		
	(1) Except for LTM R Profibus				
	(2) LTM R Modbus only				

Network (Ethernet TCP/IP)

The Network sub-menu contains the following parameters:

Level 3	Level 4	Level 5	Level 6	Parameter Name
Network	Network settings	IP address		Ethernet IP address setting
		Subnet mask		Ethernet subnet mask setting
		Gateway		Ethernet gateway address setting
		Endian		Network port endian setting
		Frame type		Network port frame type setting
		Network protocol		Communication protocol status
		FDR	FDR disable	Network port FDR disable

Level 3	Level 4	Level 5	Level 6	Parameter Name	
			Auto backup	Network port FDR auto backup enable	
			Backup period	Network port FDR auto backup period setting	
		Comm loss	Primary IP address	Ethernet primary IP address setting	
			Trip enable	Network port trip enable	
			Alarm enable	Network port alarm enable	
			Network timeout	Network port comm loss timeout	
		Device Status	Address	Device name	Ethernet device name
				MAC address	Ethernet MAC address
				IP address	Ethernet IP address
				Subnet mask	Ethernet subnet mask
	Gateway			Ethernet gateway address	
	FDR status			Network port FDR status	

History

The History sub-menu contains the following sub-menus:

Level 1	Level 2	Level 3	Level 4
Menu	Services	History	5 trips history
			Counters
			Motor history
			LTMR History

The 5 trips history sub-menu contains the following sub-menus:

Level 4	Level 5
5 trips history	Trip n-0
	Trip n-1
	Trip n-2
	Trip n-3
	Trip n-4

The **Trip n-0** sub-menu contains the following read only parameters:

Level 3	Level 4	Level 5	Level 6	Parameter Name
History	5 trips history	Trip n-0	Trip name	Trip code n-0
			Date	Date and time n-0
			Time	
			FLC setting in %	Motor full load current ratio n-0
			FLCmax	Full load current max n-0
			Thermal capacity	Thermal capacity level n-0
			Temp sensor	Motor temperature sensor n-0
			Frequency	Frequency n-0
			Average current	Average current n-0
			L1 current	L1 current n-0
			L2 current	L2 current n-0
			L3 current	L3 current n-0

Level 3	Level 4	Level 5	Level 6	Parameter Name
			Ground current	Ground current n-0
			Avg current in %	Average current ratio n-0
			L1 current in %	L1 current ratio n-0
			L2 current in %	L2 current ratio n-0
			L3 current in %	L3 current ratio n-0
			Gnd current in %	Ground current ratio n-0
			Current imbalance	Current phase imbalance n-0
			Average voltage	Average voltage n-0
			L1-L2 voltage	L1-L2 voltage n-0
			L2-L3 voltage	L2-L3 voltage n-0
			L3-L1 voltage	L3-L1 voltage n-0
			Voltage imbalance	Voltage phase imbalance n-0
			Active power	Active power n-0
			Power factor	Power factor n-0

The **Trip n-1** to **Trip n-4** sub-menus contain identical n-1 to n-4 read only parameters.

The **Counters**, **Motor history** and **LTMR history** sub-menus contain the following parameters:

Level 3	Level 4	Level 5	Parameter Name
History	Counters	All trips	Trips count
		All alarms	Alarms count
		Auto reset	Auto-resets count
		Th overld T	Thermal overload trips count
		Th overld W	Thermal overload alarms count
		Temp sens T	Motor temperature sensor trips count
		Cur imbal T	Current phase imbalance trips count
		Cur ph loss T	Current phase loss trips count
		Long start T	Long start trips count
		Jam T	Jam trips count
		Undercur T	Undercurrent trips count
		Overcur T	Overcurrent trips count
		Gnd cur T	Ground current trips count
		Volt imbal T	Voltage phase imbalance trips count
		V ph loss T	Voltage phase loss trips count
		Undervolt T	Undervoltage trips count
		Overvolt T	Overvoltage trips count
		Load shedd	Load sheddings count
		Rstart imm	Auto restart immediate count
		Rstart delay	Auto restart delayed count
		Rstart manu	Auto restart manual count
UnderPw T	Underpower trips count		
OverPw T	Overpower trips count		
Under Pfact T	Under power factor trips count		

Level 3	Level 4	Level 5	Parameter Name
History (continued)		Over Pfact T	Over power factor trips count
		HMI loss T	HMI port trips count
	Counters	Net cfg T	Network port config trips count
		Network T	Network port trips count
		Diagnostic T	Diagnostic trips count
		Wiring detected error	Wiring trips count
		Internal T	Controller internal trips count
		Int link T	Internal port trips count
	Motor history	Operating time	Operating time
		Motor Starts	Motor starts count
		Last start dur	Motor last start duration
		Last start current	Motor last start current ratio
		Power Wh	Active power consumption
		Power VARh	Reactive power consumption
	LTMR History	LTMR max temp	Controller internal temperature max
		LO1 closings	Motor LO1 closings count
		LO2 closings	Motor LO2 closings count

Config

The Config sub-menu contains the following parameters:

Level 3	Level 4	Parameter Name
Config	Enter config	Controller system config required
	End config	

Settings

The Settings sub-menu contains the following parameters:

Level 3	Level 4	Parameter Name	
Settings	FDR backup now	FDR data backup command	
	FDR restore now	FDR data restore command	
	Channels		Config via HMI keypad enable
			Config via HMI engineering tool enable
			Config via network port enable

Product ID

The Product ID sub-menu contains the following read-only parameters:

Level 3	Level 4	Parameter Name
Product ID	LTMR	Controller commercial reference
	LTME	Expansion commercial reference

Self-Test

The Self test sub-menu contains the following read-only parameters:

Level 3	Level 4	Parameter Name
Self test	Trip enable	Test trip enable
	Self test now	Self test command

Clear

The Clear sub-menu contains the following editable parameters:

Level 3	Level 4	Parameter Name
Clear	Clear all	Clear all command
	Controller setting	Clear controller settings command
	Network setting	Clear network port settings command
	Statistics	Clear statistics command
	Thermal capacity	Clear thermal capacity level command

Chapter 5

Using the LTMCU Control Operator Unit with FDR (Fast Device Replacement)

Overview

This chapter introduces the LTMCU Control Operator Unit with FDR (Fast Device Replacement).

Presentation of the LTMCUF Control Operator Unit

Aim of the product



HMI FDR services facilitate operator task when replacing a drawer in a high continuity of service environment, without needing a computer nor expertise in configuring LTMR

Description

The reference LTMCUF includes all the LTMCU reference features.

In addition LTMCUF integrates the FDR services: Fast Device Replacement.

A non-volatile memory of 8MB enables LTMR's memory (configuration and custom logic files) to be saved.

LTMCU will not integrate the FDR services.

FDR services are provided by the LTMCUF HMI itself that will allow users to backup and restore LTMR's memory into LTMCUF's memory.

These services don't need a network connection and thus no PLC like on Ethernet FDR services.

They are:

- available for all LTMR references whatever the communication protocol (Modbus, Canopen, DeviceNet, Profibus, Ethernet),

- independent from the power supply type.

In case Ethernet DHCP addressing mode is used, HMI FDR is disabled to avoid priority conflict between Ethernet FDR and HMI FDR

Principles

The whole operation can be automatically done with minimal work for the operator.

Back service

Once the LTMR is set up (at commissioning stage, for instance), the operator can save the LTMR's memory into the LTMCUF memory through the HMI interface.

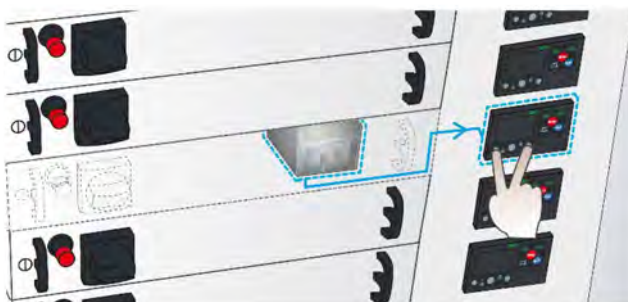

Restore service

In case of a drawer replacement, the operator just has to:

- Rack out the drawer to be replaced.

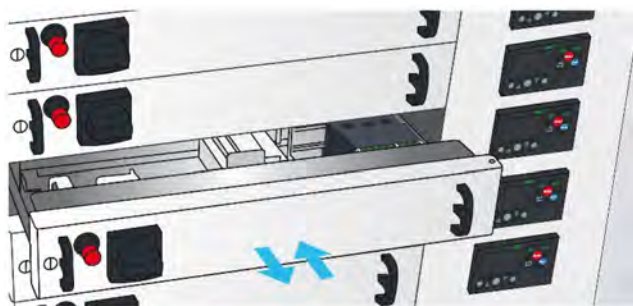

- Rack in a spare drawer. The LTMCUF installed in a fixed part of the panel will automatically detect the new LTMR and upload the recorded configuration to the new LTMR.
- Acknowledge message for uploading the configuration to the LTMR (optional).

If LTMCUF is installed in the drawer itself, the operator has to remove it then install it in the spare drawer.



Copy/Paste a configuration on several LTMRs

LTMCUF can be combined with LTM9KCU to create a portable LTMCUF (see “Mounting a Portable LTMCU”) and upload the same configuration on several LTMR units:

- Copy (by using Backup service) the configuration from the first LTMR unit.
- Paste (by using Restore service) the configuration to the other LTMR units.
- Through the HMI menu, set the network address for each LTMR unit, see .

Using LTMCUF (Fast Device Replacement)

Using LTMCUF is similar to using LTMCU, see .

This chapter only describes how to use specific FDR (Fast Device Replacement) services and related menus.



Backup service

In the HMI menu, when selecting the Backup service all the LTMR settings (configurations settings, LTMR and LTME commercial references, and custom logic file if used) will be downloaded to the internal non-volatile memory of LTMCUF.

The fastest way to back up the settings is to simultaneously press the two buttons with green circles for 3 seconds. The LTMCUF will start a backup sequence. This operation is equivalent to step 1 to 3 in the table below.

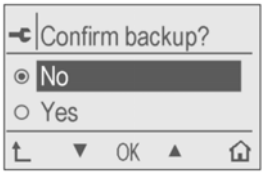
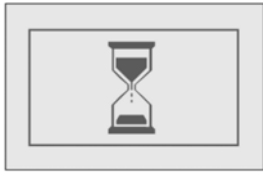
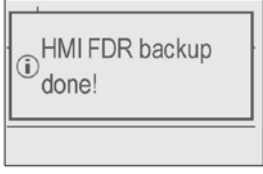

The other way to back up the LTMR settings is described in the table below.

Step	Description	Screen Display
1	Press ▼ to select the “HMI FDR” sub-menu and press “OK” to enter.	
2	Press ▼ to select the “FDR backup now” and press “OK” to enter.	
3	Press to ▼ select “Yes” and press “OK” to do the backup service. You can choose “No” to return to “FDR backup now” sub-menu. You can also press ↑ to return to the upper menu, or press  on the right to return to the main menu.	
4	Backup is in progress.	
5	Backup is completed. After 5 seconds, the display will return to the main menu automatically.	

Restore service

Restoration is done automatically during the LTMCUF startup sequence. It reads configuration of LTMR and compares it with the saved configuration. If the two configurations are different, LTMCUF starts to restore the configuration. LTMCUF will upload the backup memory to LTMR.





The restore operation is started if:

- the motor is not running,
- the LTMR and LTME commercial references match the previous configuration,
- Backed-up memory is valid (inside LTMCUF).

The restore command can also be done manually through the Restore menu.

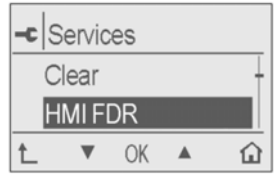
If custom logic is used or the Ethernet network address has changed, LTMR will reboot.

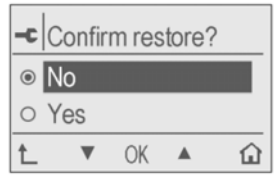
The motor needs to be stopped during the entire FDR process.

Step	Description	Screen Display
1	Press ▼ to select the “HMI FDR” sub-menu and press “OK” to enter.	
2	Press ▼ to select “FDR restore now” and press “OK” to enter. Verify that Backup service has been done before Restore service.	
3	Press ▼ to select “Yes” and press “OK” to start the Restore service. You can choose “No” to return to “FDR restore now” sub-menu. You can also press ↶ to return to the upper menu, or press 🏠 on the right to return to the main menu.	
4	Restore is in progress.	
5	Restore is completed. After 5 seconds, the display will return to the main menu automatically.	

⚠ WARNING

UNINTENDED EQUIPMENT OPERATION

LTMCUF only checks that the hardware configuration matches the saved memory. Before any operation, the user should verify that the configuration saved into LTMCUF is suitable for the application of the targeted LTMR. If a detected error message appears during FDR operation, a qualified operator should check the detected error root cause and recheck the configuration.

Failure to follow these instructions can result in death, serious injury, or equipment damage.

HMI FDR settings

LTMCUF settings are not available in SoMove and have to be done with the HMI menu interface.

Confirm at start:

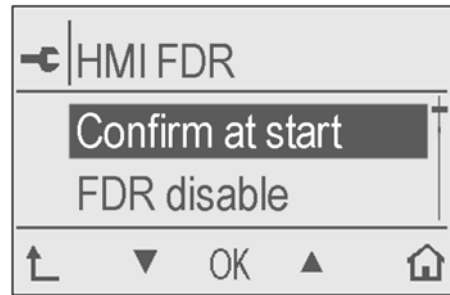

This setting lets the user choose the Restore behavior at startup. 2 options exist:

- Confirm at start enabled/disabled,
- FDR enabled/disabled.

Confirm at start enabled:



When the Restore service automatically starts, the user will have to choose between accepting to restore (OK) or cancelling (back button).

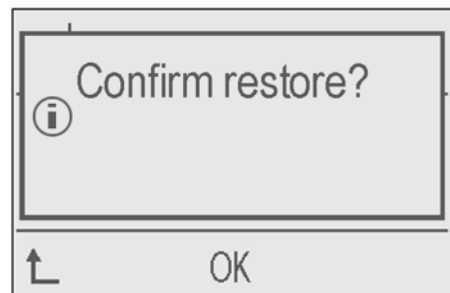

Confirm at start disabled:

If “Confirm at start” is not selected, the restore is done automatically at startup. The user has 5 seconds to cancel the operation by pushing any of the 5 navigation buttons. Otherwise, after 5 seconds the Restore service will start.

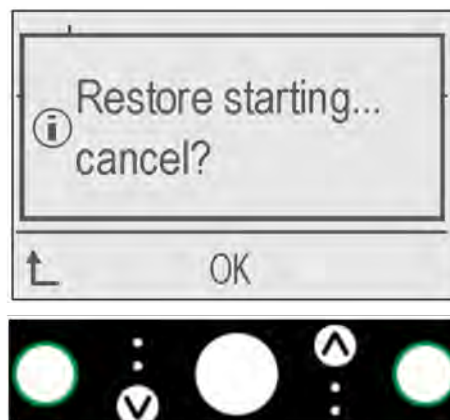

Disable HMI FDR

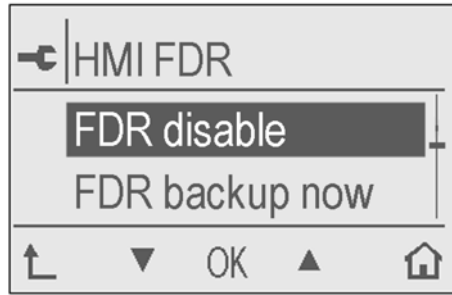

“FDR disable” is an option to deactivate the HMI FDR services in case the user wants to use LTMCUF as a basic LTMCU. By default, the HMI FDR services are enabled.

Menu – FDR settings

Overview

The HMI FDR sub-menu gives access to FDR parameters.

Level 1	Level 2	Level 3
Menu	Services	Date-Time setting
		HMI setting
		Network
		History
		Config
		Settings
		Product ID
		Self-test
		Clear
		HMI FDR

FDR sub-menu

The HMI FDR sub-menu contains the following editable parameters.

Level 3	Level 4	Parameter name
HMI FDR	Confirm at start	Restore startup can be done automatically (the user has 5 seconds to cancel “Restore”) or manually (the user has to accept with “OK” or cancel with “  ”). If “Confirm at start” is selected, the Restore service is in manual mode.
	FDR disable	Disable/Enable Restore service at startup.
	FDR backup now	Start to back up LTMR memory to LTMCUF.
	FDR restore now	Start to restore LTMR memory from LTMCUF.

Troubleshooting

Overview

LTMCUF will work on the same commercial references and at its best with the same LTMR firmware (FW) version, with optimal compatibility from FW pack 10.

LTMCUF will manage all settings registers of current LTMR firmware version and all anterior firmware versions.

If there is a register mismatch between 2 firmware versions and a risk of parameter not being fully downloaded, LTMCUF displays a detected error message.

See the troubleshooting list below. Some detected errors are not critical and only indicate that a few registers could not be written. For example, some registers in memory are related to LTME, and LTME is not connected.

Another example: if LTMR is in a trip state during Restore/Backup command, it will be prevented from writing to registers related to the trip. LTMCUF will then display "Error code F07". From FW pack 10, LTMR will have the specific access right to write trip register even in trip.

Trips and Alarm display

LTMCUF detects errors related to FDR services are displayed following the diagram below:

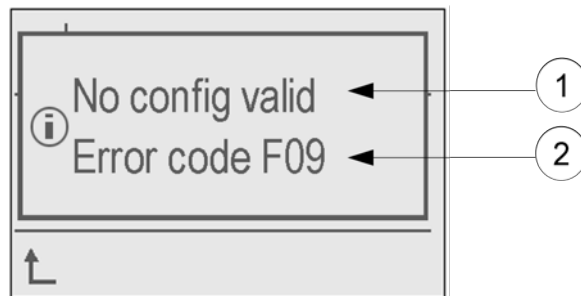

1 Trip/Alarm name
Detected error Code

By default, when LTMCUF is new, the detected error F09 "No config valid" appears as the LTMCUF memory is empty. This is a reminder that a backup operation needs to be done before using the FDR services.

Troubleshooting

Trip/Alarm name	Detected Error Code	Probable Cause	Checks or repairs
Target not match	F01	<p>Target not match</p> <p>Targeted product commercial reference does not match the saved configuration.</p> <p>For example a config for Canopen cannot be transferred on a Modbus LTMR or a config for LTMR08 will not work on LTMR27 because of different current ranges.</p>	The user made a mistake on the target. Operate FDR on products with the same references.

Trip/Alarm name	Detected Error Code	Probable Cause	Checks or repairs
	F02	EtherNet version mismatch The target product is not compatible with the device profile recorded in the memory in terms of firmware or hardware.	Replace the targeted product with a compatible firmware and hardware version.
	F03	Ground current settings LTMCUF has not been able to write part of registers related to ground current protection. Possible reason is register range change between 2 different firmware versions.	Verify settings for: <ul style="list-style-type: none"> ground current protection disable at start reg 559.1 ground current trip and alarm settings minimum value: register 557,558,611,612. Another solution: use HMI FDR with same LTMR Firmware version. Then retry HMI FDR.
	F04	Network address is default value and cannot be written by LTMCUF. Set the network address.	Set a valid network address then redo backup operation.
	F05	LTME. Some settings related to LTME are activated but target does not have LTME connected.	Connect a LTME or verify the target is the correct one.
Restore Detected error or detected failure	F06	Restore Detected error or detected failure because at least one register had timeout when written . Restore has been interrupted.	Power off LTMR or LTMCUF and reconnect it to restart a restore. If detected error happens again please contact regional technical support.
	F07	Product is in trip state and registers linked to trip (637 to 642) cannot be written.	Cancel the trip condition then reset trip and redo restore.
	F08	LTMCU FW unknown registers. This can happen if new LTMR firmware requires additional registers not supported by LTMCUF.	Reserved trip code for future use.
No config valid	F09	No configuration loaded in memory or checksum trip (=configuration not valid).	Do backup memory again.
Motor is running	F10	When motor is running , some settings of LTMR cannot be modified so FDR cannot start.	Stop motor and retry HMI FDR.
Config via HMI not allowed	F11	Configuration through HMI port is disabled inside LTMR settings meaning that HMI FDR cannot work. Configuration via engineering tool is not allowed (register 601.09) or configuration via HMI is not allowed (register 601.08).	Use SoMove to Enable register 601.08 and 601.09.
Backup detected error or detected failure	F08	LTMCU FW unknown registers. Error detected if new firmware requires additional registers not supported by LTMCUF.	Reserved trip code for future FW package.
	F12	At least one register had timeout. Backup has been interrupted.	Power off LTMR and retry backup operation. If detected error happens again please contact regional technical support.

When a detected error or detected failure occurs, please press  to return to the main menu.

Index

A

AC inputs.....	46
active power	
consumption.....	56
n-0.....	55
alarm enable	
motor temperature sensor.....	46
alarms count.....	55
auto resets	
count.....	55
auto restart	
delayed count.....	55
delayed timeout.....	49
immediate count.....	55
immediate timeout.....	49
manual count.....	55
auto-reset	
attempts group 1 setting.....	50
attempts group 2 setting.....	50
attempts group 3 setting.....	51
group 1 timeout.....	50
group 2 timeout.....	51
group 3 timeout.....	51
average current	
n-0.....	54
average current ratio	
n-0.....	55
average voltage	
n-0.....	55

C

command	
clear all.....	57
clear controller settings.....	57
clear network port settings.....	57
clear statistics.....	57
clear thermal capacity level.....	57
FDR data backup.....	56
FDR data restore.....	56
self test.....	57
Communication	
protocol.....	44
protocol status.....	53
config via	
HMI engineering tool enable.....	56
HMI keypad enable.....	56
network port enable.....	56
connecting.....	18
cables.....	18
RJ45.....	18
to a PC.....	19
to LTMR controller.....	19
contactor rating.....	51
control	
local channel setting.....	44, 50
remote channel setting.....	50
control direct transition.....	51
Control setting	
parameters.....	49
control transfer mode.....	50
controller	
commercial reference.....	56
internal temperature max.....	56
internal trips count.....	56

system config required.....	44, 56
Cround trip	
disabled in start.....	47
current phase imbalance	
alarm enable.....	47
alarm threshold.....	47
frip enable.....	47
n-0.....	55
trip threshold.....	47
trip timeout running.....	47
trip timeout starting.....	47
trips count.....	55
current phase loss	
alarm enable.....	47
timeout.....	47
trip enable.....	47
trips count.....	55
current phase reversal	
trip enable.....	47

D

date and time	
n-0.....	54
setting.....	52
diagnostic	
alarm enable.....	50
trip enable.....	50
trips count.....	56
dimensions.....	11

E

Ethernet	
device name.....	54
gateway address.....	54
gateway address setting.....	53
IP address.....	54
IP address setting.....	53
MAC address.....	54
primary IP address setting.....	54
subnet mask.....	54
subnet mask setting.....	53
expansion	
FDR data.....	56
external ground current	
alarm threshold.....	48
trip threshold.....	47
trip timeout.....	47

F

first setup	
HMI language.....	44
parameters.....	43
frequency	
n-0.....	54

G

ground CT	
primary.....	46
ratio.....	46
secondary.....	46
ground current	
alarm enable.....	47
n-0.....	55

trip enable	47
trips count	55
ground current ratio	
n-0	55

H

HMI

keypad password	53
language setting	52

HMI display

31-L1 voltage enable	52
active power enable	52
average current enable	52
average current ratio enable	52
average voltage enable	52
brightness setting	52
contrast setting	52
control mode enable	53
current phase imbalance enable	52
date setting	52
frequency enable	53
ground current enable	52
I/O status enable	53
L1 current enable	52
L1 current ratio enable	52
L1-L2 voltage enable	52
L2 current enable	52
L2 current ratio enable	52
L2-L3 voltage enable	52
L3 current enable	52
L3 current ratio enable	52
last alarm enable	53
last trip enable	53
motor status enable	52
motor status LED color	52
motor temperature sensor enable	53
operating time enable	53
power consumption enable	52
power factor enable	52
reactive power enable	52
start statistics enable	52
starts per hour enable	53
thermal capacity level enable	52
thermal capacity remaining enable	52
time setting	52
time to trip enable	52
voltage phase imbalance enable	52

HMI port

baud rate setting	53
fallback setting	50
parity setting	53
trips count	56
HMI remote local key default	50
HMI remote local key enable	50

I

interface

physical description	28
----------------------------	----

internal ground current

alarm threshold	48
trip threshold	47
trip timeout	47

internal port

trips count	56
-------------------	----

J

jam

alarm enable	47
alarm threshold	47
Trip enable	47
trip threshold	47
trip timeout	47
trips count	55

L

L1 current

n-0	54
-----------	----

L1 current ratio

n-0	55
-----------	----

L1-L2 voltage

n-0	55
-----------	----

L2 current

n-0	54
-----------	----

L2 current ratio

n-0	55
-----------	----

L2-L3 voltage

n-0	55
-----------	----

L3 current

n-0	54
-----------	----

L3 current ratio

n-0	55
-----------	----

L3-L1 voltage

n-0	55
-----------	----

label

inserting	12
-----------------	----

langtool

files	22
local folder	22
patch	22

language

LTM CU display	7
LTMCU Langtool	21
management	21
tool	21

load CT

multiple passes	44–45
primary	44–45
ratio	45
secondary	44–45

load shedding

timeout	49
---------------	----

load sheddings count

.....	55
-------	----

local control interface

control keys	36
label	11
LEDs	38

logic input 3 external ready enable

.....	50
-------	----

long start

trip enable	47
trip threshold	47
trip timeout	47
trips count	55

LTM CU

displays	30
----------------	----

LTMCU

contextual navigation keys	28
language	43

LTMCU display

icons	29
-------------	----

LTMCU Langtool	21–22
----------------------	-------

download	22
----------------	----

download area	24
---------------------	----

Language folder	22, 24	frame type setting	53
language selection	25	parity	53
LTM CU area	24	parity setting	53
PC area	24	trip enable	53–54
		trips count	56
M			
menus		O	
Control setting	49	operating time	56
First setup	43	over power factor	
main menu	44	alarm enable	49
Menu	44	alarm threshold	49
Metering setting	45	trip enable	49
navigating	39	trip threshold	49
Protection setting	46	trip timeout	49
Services	51	trips count	56
Metering setting		overcurrent	
parameters	45	alarm enable	47
motor		alarm threshold	47
auxiliary fan cooled	46	trip enable	47
full load current ratio	44	trip threshold	47
full load current ratio, FLC1	46	trip timeout	47
high speed full load current ratio	44	trips count	55
high speed full load current ratio, FLC2	46	overpower	
nominal power	44–45	alarm enable	48
nominal voltage	44–45	alarm threshold	48
operating mode	44, 51	trip enable	48
phases	44–45	trip threshold	48
phases sequence	47	trip timeout	48
step 1 to 2 threshold	44, 51	trips count	55
step 1 to 2 timeout	44, 51	overvoltage	
temperature sensor alarm threshold	47	alarm enable	48
temperature sensor alarm threshold degree	47	alarm threshold	48
temperature sensor trip threshold	46	trip enable	48
temperature sensor trip threshold degree	46	trip threshold	48
temperature sensor type	45	trip timeout	48
transition timeout	51	trips count	55
trip class	44, 46		
motor full load current max		P	
n-0	54	password	
motor full load current ratio		access	42
n-0	54	power factor	
motor last start current duration	56	n-0	55
motor last start duration	56	protection	
motor star delta	44, 51	password	42
motor starts count	56	Protection setting	
motor temperature sensor		parameters	46
display CF	52		
n-0	54	Q	
trips count	55	Quick View	29–30, 33
mounting	13	automatic scroll mode	34
		manual scroll mode	35
N			
network port		R	
address	53	rapid cycle	
address setting	53	lockout timeout	51
alarm enable	53–54	reactive power	
baud rate	53	consumption	56
baud rate setting	53		
comm loss timeout	53–54	S	
config trips count	56	Services	
endian setting	53	parameters	51
fallback setting	50	SoMove	8
FDR auto backup enable	54		
FDR auto backup period setting	54		
FDR disable	53		
FDR status	54		

starts count
 motor LO1 56
 motor LO2 56
 stop HMI disable 50
 stop terminal strip disable..... 50

T

test trip enable 57
 thermal capacity level
 n-0 54
 thermal overload
 alarm enable..... 46
 alarm threshold 46
 alarms count..... 55
 mode 44, 46
 trip definite timeout..... 44, 46
 Trip enable 46
 trip reset threshold 46
 trips count 55
 trip code
 n-0 54
 trip enable
 motor temperature sensor..... 46
 trip reset mode 50
 trips and alarms display 35
 trips count..... 55

U

under power factor
 alarm enable..... 49
 alarm threshold 49
 trip enable 49
 trip threshold..... 49
 trip timeout 49
 trips count 55
 undercurrent
 alarm enable..... 47
 alarm threshold 47
 trip enable 47
 trip threshold..... 47
 trip timeout 47
 trips count 55
 underpower
 alarm enable..... 48
 alarm threshold 48
 trip enable 48
 trip threshold..... 48
 trip timeout 48
 trips count 55
 undervoltage
 alarm enable..... 48
 alarm threshold 48
 trip enable 48
 trip threshold..... 48
 trip timeout 48
 trips count 55

V

values
 editing in a list..... 40
 editing numerical values 41
 voltage dip
 mode 49
 restart threshold..... 49
 restart timeout 49

threshold 49
 voltage phase imbalance
 alarm enable..... 48
 alarm threshold 48
 n-0 55
 trip enable 48
 trip threshold..... 48
 trip timeout 48
 trip timeout running 48
 trip timeout starting..... 48
 trips count 55
 voltage phase loss
 alarm enable..... 48
 trip enable 48
 trips count 55
 voltage phase reversal
 trip enable 48

W

wiring
 trip enable 50
 trips count 56

Schneider Electric
800 Federal Street
Andover, MA 01810
USA

888-778-2733

www.se.com

As standards, specifications, and design change from time to time,
please ask for confirmation of the information given in this publication.

© 2014 – 2022 Schneider Electric. All rights reserved.

1639581EN-06