



VTE18-3E2112

V18

CYLINDRICAL PHOTOELECTRIC SENSORS

**SICK**  
Sensor Intelligence.



### Ordering information

| Type         | Part no. |
|--------------|----------|
| VTE18-3E2112 | 6013375  |

Other models and accessories → [www.sick.com/V18](http://www.sick.com/V18)

Illustration may differ



### Detailed technical data

#### Features

|                                        |                                |
|----------------------------------------|--------------------------------|
| <b>Functional principle</b>            | Photoelectric proximity sensor |
| <b>Functional principle detail</b>     | Energetic                      |
| <b>Dimensions (W x H x D)</b>          | 18 mm x 18 mm x 63.6 mm        |
| <b>Housing design (light emission)</b> | Cylindrical                    |
| <b>Housing length</b>                  | 63.6 mm                        |
| <b>Thread diameter (housing)</b>       | M18 x 1                        |
| <b>Optical axis</b>                    | Axial                          |
| <b>Sensing range max.</b>              | 3 mm ... 200 mm <sup>1)</sup>  |
| <b>Sensing range</b>                   | 3 mm ... 170 mm                |
| <b>Focus</b>                           | Approx. 2.8°                   |
| <b>Type of light</b>                   | Infrared light                 |
| <b>Light source</b>                    | LED <sup>2)</sup>              |
| <b>Light spot size (distance)</b>      | Ø 10 mm (200 mm)               |
| <b>Angle of dispersion</b>             | Approx. 2.8°                   |
| <b>Adjustment</b>                      | None                           |

<sup>1)</sup> Object with 90% remission (based on standard white, DIN 5033).

<sup>2)</sup> Average service life: 100,000 h at T<sub>U</sub> = +25 °C.

## Mechanics/electronics

|                                            |                                                                           |
|--------------------------------------------|---------------------------------------------------------------------------|
| <b>Supply voltage <math>U_B</math></b>     | 10 V DC ... 30 V DC <sup>1)</sup>                                         |
| <b>Ripple</b>                              | $\pm 10\%$ <sup>2)</sup>                                                  |
| <b>Current consumption</b>                 | 30 mA <sup>3)</sup>                                                       |
| <b>Switching output</b>                    | NPN                                                                       |
| <b>Switching mode</b>                      | Light switching                                                           |
| <b>Output current <math>I_{max}</math></b> | $\leq 100$ mA                                                             |
| <b>Response time</b>                       | $\leq 2$ ms <sup>4)</sup>                                                 |
| <b>Switching frequency</b>                 | 250 Hz <sup>5)</sup>                                                      |
| <b>Connection type</b>                     | Cable, 3-wire, 2 m <sup>6)</sup>                                          |
| <b>Cable material</b>                      | PVC                                                                       |
| <b>Conductor cross section</b>             | 0.14 mm <sup>2</sup>                                                      |
| <b>Cable diameter</b>                      | $\varnothing 3.1$ mm                                                      |
| <b>Circuit protection</b>                  | A <sup>7)</sup><br>B <sup>8)</sup><br>C <sup>9)</sup><br>D <sup>10)</sup> |
| <b>Protection class</b>                    | III                                                                       |
| <b>Weight</b>                              | 120 g                                                                     |
| <b>Housing material</b>                    | Metal, Nickel-plated brass                                                |
| <b>Optics material</b>                     | Plastic, PMMA                                                             |
| <b>Enclosure rating</b>                    | IP67                                                                      |
| <b>Ambient operating temperature</b>       | -25 °C ... +70 °C                                                         |
| <b>UL File No.</b>                         | NMFT2.E175606                                                             |

<sup>1)</sup> Limit values.

<sup>2)</sup> May not exceed or fall below  $U_V$  tolerances.

<sup>3)</sup> Without load.

<sup>4)</sup> Signal transit time with resistive load.

<sup>5)</sup> With light/dark ratio 1:1.

<sup>6)</sup> Do not bend below 0 °C.

<sup>7)</sup> A =  $V_S$  connections reverse-polarity protected.

<sup>8)</sup> B = inputs and output reverse-polarity protected.

<sup>9)</sup> C = interference suppression.

<sup>10)</sup> D = outputs overcurrent and short-circuit protected.

## Classifications

|                     |          |
|---------------------|----------|
| <b>eCl@ss 5.0</b>   | 27270903 |
| <b>eCl@ss 5.1.4</b> | 27270903 |
| <b>eCl@ss 6.0</b>   | 27270903 |
| <b>eCl@ss 6.2</b>   | 27270903 |
| <b>eCl@ss 7.0</b>   | 27270903 |
| <b>eCl@ss 8.0</b>   | 27270903 |
| <b>eCl@ss 8.1</b>   | 27270903 |
| <b>eCl@ss 9.0</b>   | 27270903 |

|                       |          |
|-----------------------|----------|
| <b>eCl@ss 10.0</b>    | 27270904 |
| <b>eCl@ss 11.0</b>    | 27270904 |
| <b>eCl@ss 12.0</b>    | 27270903 |
| <b>ETIM 5.0</b>       | EC001821 |
| <b>ETIM 6.0</b>       | EC001821 |
| <b>ETIM 7.0</b>       | EC002719 |
| <b>ETIM 8.0</b>       | EC002719 |
| <b>UNSPSC 16.0901</b> | 39121528 |

### Adjustments

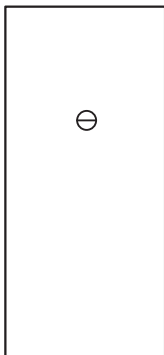

### Connection type



### Connection diagram

Cd-043

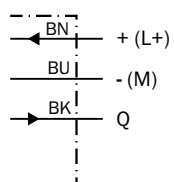

Characteristic curve

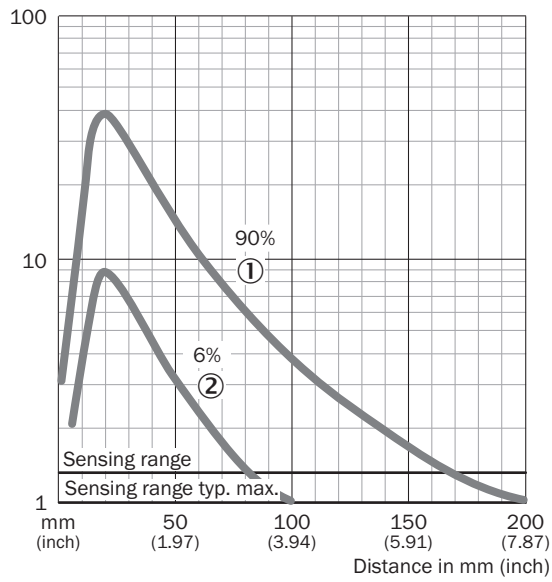

Sensing range diagram

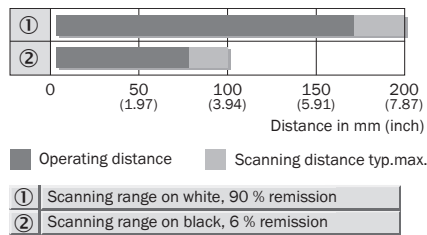

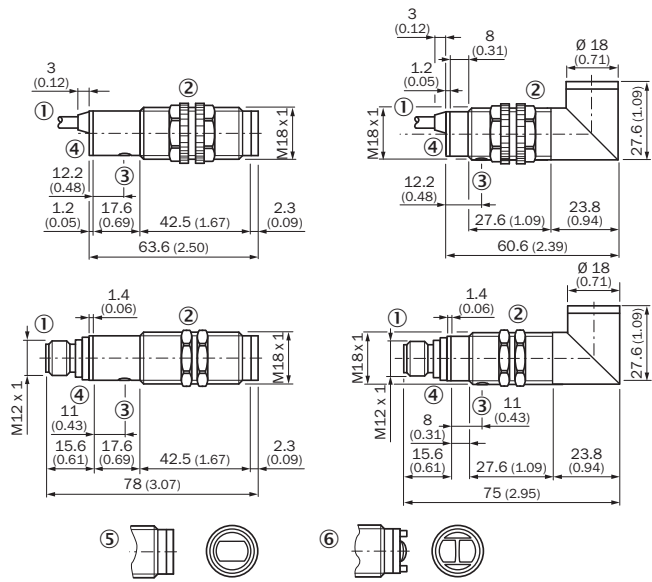

Dimensional drawing (Dimensions in mm (inch))



- ① Connecting cable or connector
- ② Fastening nut, 22 mm hex, made of plastic for equipment with plastic housing  
Fastening nut, 24 mm hex, made of metal for equipment with metal housing
- ③ Sensitivity control
- ④ Signal strength indicator, LED, yellow

Recommended accessories

Other models and accessories → [www.sick.com/V18](http://www.sick.com/V18)

|                                                                                     | Brief description                                                               | Type       | Part no. |
|-------------------------------------------------------------------------------------|---------------------------------------------------------------------------------|------------|----------|
| <b>Mounting brackets and plates</b>                                                 |                                                                                 |            |          |
|  | Mounting bracket for M18 sensors, steel, zinc coated, without mounting hardware | BEF-WN-M18 | 5308446  |
| <b>Plug connectors and cables</b>                                                   |                                                                                 |            |          |
|  | Head A: male connector, M8, 3-pin, straight<br>Cable: unshielded                | STE-0803-G | 6037322  |

## SICK AT A GLANCE

SICK is one of the leading manufacturers of intelligent sensors and sensor solutions for industrial applications. A unique range of products and services creates the perfect basis for controlling processes securely and efficiently, protecting individuals from accidents and preventing damage to the environment.

We have extensive experience in a wide range of industries and understand their processes and requirements. With intelligent sensors, we can deliver exactly what our customers need. In application centers in Europe, Asia and North America, system solutions are tested and optimized in accordance with customer specifications. All this makes us a reliable supplier and development partner.

Comprehensive services complete our offering: SICK LifeTime Services provide support throughout the machine life cycle and ensure safety and productivity.

For us, that is “Sensor Intelligence.”

## WORLDWIDE PRESENCE:

Contacts and other locations –[www.sick.com](http://www.sick.com)