



# CFP0300-XPANNCT

CFP Cubic

**CAPACITIVE LEVEL SENSOR**

**SICK**  
Sensor Intelligence.



### Ordering information

Type	Part no.
CFP0300-XPANNCT	1090859

Other models and accessories → [www.sick.com/CFP\\_Cubic](http://www.sick.com/CFP_Cubic)

Illustration may differ



### Detailed technical data

#### Features

<b>Medium</b>	Fluids
<b>Measurement</b>	Switch, Continuous
<b>Probe length</b>	300 mm
<b>Process pressure</b>	-0.5 bar ... 3 bar
<b>Process temperature</b>	-20 °C ... +80 °C
<b>UL approval</b>	✓
<b>RoHS certificate</b>	✓
<b>IO-Link</b>	✓

#### Performance

<b>Accuracy of sensor element</b>	± 15 mm, with water or oil under reference conditions
<b>Reproducibility</b>	< 5 mm
<b>Resolution</b>	< 2 mm
<b>Response time</b>	< 300 ms
<b>Dielectricity constant</b>	≥ 2
<b>Conductivity</b>	No limitation
<b>Deactivated area at end of probe</b>	7 mm ... 15 mm, Depending on probe length
<b>MTTF</b>	171 years
<b>Display</b>	✓
<b>Temperature measurement</b>	
Measuring range (temperature)	-20 °C ... +80 °C
Measurement accuracy (temperature)	± 2 °C
Resolution (Temperature)	≤ 0.1 °C

Response time (temperature)	120 s
-----------------------------	-------

## Electronics

<b>Supply voltage</b>	10 V DC ... 30 V DC <sup>1)</sup>
<b>Power consumption</b>	≤ 100 mA at 24 V DC without output load
<b>Initialization time</b>	≤ 4 s
<b>Protection class</b>	III
<b>Connection type</b>	M12 round connector x 1, 8-pin
<b>Output signal</b>	4 x PNP/NPN/push-pull transistor outputs switchable and 2 x analog outputs 4 mA ... 20 mA, 0 V ... 10 V depending on output load or output voltage depending on the load
<b>Output load</b>	4 mA ... 20 mA < 500 Ohm at Uv > 15 V, 4 mA ... 20 mA < 350 Ohm at Uv > 12 V, 0 V ... 10 V > 750 Ohm at Uv 14 ≥ V
<b>Hysteresis</b>	Min. 3 mm, min. 2 °C, free adjustable
<b>Output current</b>	< 100 mA
<b>Inductive load</b>	< 1 H
<b>Capacitive load</b>	100 nF
<b>Enclosure rating</b>	IP67
<b>Temperature drift</b>	< 0.1 mm/K
<b>Lower signal level</b>	3.8 mA ... 4 mA
<b>Upper signal level</b>	20 mA ... 20.5 mA
<b>Resolution of analog output</b>	12 bit

<sup>1)</sup> All connections are polarity protected. All outputs are overload and short-circuit protected.

## Mechanics

<b>Wetted parts</b>	Outer tube: polypropylene (PP-H) G ¾" and ¾" NPT: PPSU Easy-clamp bracket: PP
<b>Process connection</b>	G ¾ A
<b>Housing material</b>	PBT / PC
<b>Max. probe load</b>	≤ 4 Nm
<b>Probe diameter</b>	16 mm

## Ambient data

<b>Ambient operating temperature</b>	-20 °C ... +60 °C
<b>Ambient temperature, storage</b>	-40 °C ... +80 °C

## Classifications

<b>ECLASS 5.0</b>	27200503
<b>ECLASS 5.1.4</b>	27200503
<b>ECLASS 6.0</b>	27200503
<b>ECLASS 6.2</b>	27200503
<b>ECLASS 7.0</b>	27200503
<b>ECLASS 8.0</b>	27200503
<b>ECLASS 8.1</b>	27200503
<b>ECLASS 9.0</b>	27200503

# CFP0300-XPANNCT | CFP Cubic

## CAPACITIVE LEVEL SENSOR

<b>ECLASS 10.0</b>	27200503
<b>ECLASS 11.0</b>	27200503
<b>ECLASS 12.0</b>	27200503
<b>ETIM 5.0</b>	EC001447
<b>ETIM 6.0</b>	EC001447
<b>ETIM 7.0</b>	EC001447
<b>ETIM 8.0</b>	EC001447
<b>UNSPSC 16.0901</b>	41113710

### Type code

#### Probe length in mm

0100	100 mm (in increments of 50 mm)
0500	500 mm (in increments of 100 mm)
1000	1,000 mm

#### Special design

P Rod probe from PP

#### Process connection

- X Without process connection
- A G 3/4 A; made from PBT
- B 3/4" NPT; made from PBT

#### Application type

N Oil and water application

#### Housing

N Plastic housing with display

#### Electrical output

- A 2 digital outputs
- B 2 digital outputs + 1 analog output
- C 4 digital outputs + 2 analog outputs

#### Additional option

- T With temperature sensor
- X No additional options

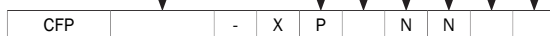

Not all variants of the type code can be combined!

### Dimensional drawing (Dimensions in mm (inch))

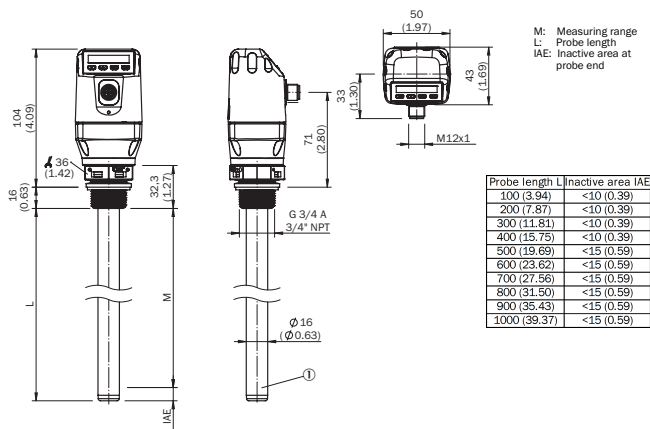

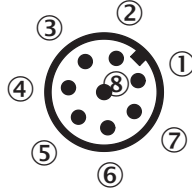
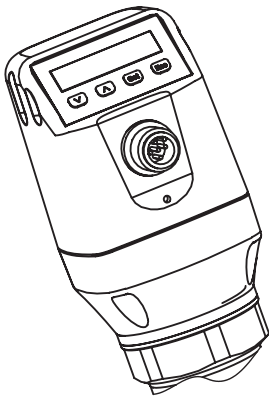

## Connection type





- ① L<sup>+</sup>: Supply voltage
- ② Q<sub>2</sub>: Switching output 2, PNP/NPN/DRV (Push-Pull)
- ③ M: Ground, reference ground for current-/voltage output
- ④ C/Q1: Switching output 2, PNP/NPN/DRV (Push-Pull) / IO-Link
- ⑤ Q<sub>3</sub>: Switching output 3, PNP/NPN/DRV (Push-Pull)
- ⑥ Q<sub>4</sub>: Switching output 4, PNP/NPN/DRV (Push-Pull)
- ⑦ Q<sub>A</sub>: Analog current-/voltage output
- ⑧ Q<sub>B</sub>: Analog current-/voltage output

## Recommended accessories

Other models and accessories → [www.sick.com/CFP\\_Cubic](http://www.sick.com/CFP_Cubic)

	Brief description	Type	Part no.
Connection modules			
	IO-Link V1.1 Class A port, USB2.0 port, optional external power supply 24V / 1A	IOLA2US-01101 (SiLink2 Master)	1061790
Plug connectors and cables			
	<ul style="list-style-type: none"> <li>• <b>Connection type head A:</b> Female connector, M12, 8-pin, straight, A-coded</li> <li>• <b>Connection type head B:</b> Flying leads</li> <li>• <b>Signal type:</b> Sensor/actuator cable</li> <li>• <b>Cable:</b> 2 m, 8-wire, PUR, halogen-free</li> <li>• <b>Description:</b> Sensor/actuator cable, unshielded</li> <li>• <b>Application:</b> Zones with oils and lubricants, Drag chain operation, Robot</li> </ul>	YF2A18-020UA5XLEAX	2095652
	<ul style="list-style-type: none"> <li>• <b>Connection type head A:</b> Female connector, M12, 8-pin, straight, A-coded</li> <li>• <b>Connection type head B:</b> Flying leads</li> <li>• <b>Signal type:</b> Sensor/actuator cable</li> <li>• <b>Cable:</b> 5 m, 8-wire, PUR, halogen-free</li> <li>• <b>Description:</b> Sensor/actuator cable, unshielded</li> <li>• <b>Application:</b> Zones with oils and lubricants, Drag chain operation, Robot</li> </ul>	YF2A18-050UA5XLEAX	2095653
	<ul style="list-style-type: none"> <li>• <b>Connection type head A:</b> Female connector, M12, 8-pin, straight, A-coded</li> <li>• <b>Connection type head B:</b> Flying leads</li> <li>• <b>Signal type:</b> Sensor/actuator cable</li> <li>• <b>Cable:</b> 10 m, 8-wire, PUR, halogen-free</li> <li>• <b>Description:</b> Sensor/actuator cable, unshielded</li> <li>• <b>Application:</b> Zones with oils and lubricants, Drag chain operation, Robot</li> </ul>	YF2A18-100UA5XLEAX	2095654

	Brief description	Type	Part no.
	<ul style="list-style-type: none"> <li>• <b>Connection type head A:</b> Female connector, M12, 8-pin, straight, A-coded</li> <li>• <b>Connection type head B:</b> Flying leads</li> <li>• <b>Signal type:</b> Sensor/actuator cable</li> <li>• <b>Cable:</b> 2 m, 8-wire, PVC</li> <li>• <b>Description:</b> Sensor/actuator cable, shielded</li> <li>• <b>Application:</b> Zones with chemicals</li> </ul>	YF2A28-020VA6XLEAX	2096243
	<ul style="list-style-type: none"> <li>• <b>Connection type head A:</b> Female connector, M12, 8-pin, straight, A-coded</li> <li>• <b>Connection type head B:</b> Flying leads</li> <li>• <b>Signal type:</b> Sensor/actuator cable</li> <li>• <b>Cable:</b> 5 m, 8-wire, PVC</li> <li>• <b>Description:</b> Sensor/actuator cable, shielded</li> <li>• <b>Application:</b> Zones with chemicals</li> </ul>	YF2A28-050VA6XLEAX	2096244
	<ul style="list-style-type: none"> <li>• <b>Connection type head A:</b> Female connector, M12, 8-pin, straight, A-coded</li> <li>• <b>Connection type head B:</b> Flying leads</li> <li>• <b>Signal type:</b> Sensor/actuator cable</li> <li>• <b>Cable:</b> 10 m, 8-wire, PVC</li> <li>• <b>Description:</b> Sensor/actuator cable, shielded</li> <li>• <b>Application:</b> Zones with chemicals</li> </ul>	YF2A28-100VA6XLEAX	2096245
	<ul style="list-style-type: none"> <li>• <b>Connection type head A:</b> Female connector, M12, 8-pin, angled, A-coded</li> <li>• <b>Connection type head B:</b> Flying leads</li> <li>• <b>Signal type:</b> Sensor/actuator cable</li> <li>• <b>Cable:</b> 2 m, 8-wire, PUR, halogen-free</li> <li>• <b>Description:</b> Sensor/actuator cable, unshielded</li> <li>• <b>Application:</b> Zones with oils and lubricants, Drag chain operation, Robot</li> </ul>	YG2A18-020UA5XLEAX	2095779
	<ul style="list-style-type: none"> <li>• <b>Connection type head A:</b> Female connector, M12, 8-pin, angled, A-coded</li> <li>• <b>Connection type head B:</b> Flying leads</li> <li>• <b>Signal type:</b> Sensor/actuator cable</li> <li>• <b>Cable:</b> 5 m, 8-wire, PUR, halogen-free</li> <li>• <b>Description:</b> Sensor/actuator cable, unshielded</li> <li>• <b>Application:</b> Zones with oils and lubricants, Drag chain operation, Robot</li> </ul>	YG2A18-050UA5XLEAX	2095780
	<ul style="list-style-type: none"> <li>• <b>Connection type head A:</b> Female connector, M12, 8-pin, angled, A-coded</li> <li>• <b>Connection type head B:</b> Flying leads</li> <li>• <b>Signal type:</b> Sensor/actuator cable</li> <li>• <b>Cable:</b> 10 m, 8-wire, PUR, halogen-free</li> <li>• <b>Description:</b> Sensor/actuator cable, unshielded</li> <li>• <b>Application:</b> Zones with oils and lubricants, Drag chain operation, Robot</li> </ul>	YG2A18-100UA5XLEAX	2095781
	<ul style="list-style-type: none"> <li>• <b>Connection type head A:</b> Female connector, M12, 8-pin, angled, A-coded</li> <li>• <b>Connection type head B:</b> Flying leads</li> <li>• <b>Signal type:</b> Sensor/actuator cable</li> <li>• <b>Cable:</b> 2 m, 8-wire, PVC</li> <li>• <b>Description:</b> Sensor/actuator cable, shielded</li> <li>• <b>Application:</b> Zones with chemicals</li> </ul>	YG2A28-020VA6XLEAX	2096218
	<ul style="list-style-type: none"> <li>• <b>Connection type head A:</b> Female connector, M12, 8-pin, angled, A-coded</li> <li>• <b>Connection type head B:</b> Flying leads</li> <li>• <b>Signal type:</b> Sensor/actuator cable</li> <li>• <b>Cable:</b> 5 m, 8-wire, PVC</li> <li>• <b>Description:</b> Sensor/actuator cable, shielded</li> <li>• <b>Application:</b> Zones with chemicals</li> </ul>	YG2A28-050VA6XLEAX	2096219
Sensor Visualization			
	<ul style="list-style-type: none"> <li>• <b>Product category:</b> LED signal lamp</li> <li>• <b>Further functions:</b> IO-Link signal lamp, Parameterization via IO-Link, Simple configuration directly via the SOPAS ET user interface, the engineering tool from SICK</li> </ul>	SLT060-0B010J700	6075938

## Recommended services

Additional services → [www.sick.com/CFP\\_Cubic](https://www.sick.com/CFP_Cubic)

	Type	Part no.
Function Block Factory		
<ul style="list-style-type: none"><li>• <b>Description:</b> The Function Block Factory supports common programmable logic controllers (PLCs) from various manufacturers, such as Siemens, Beckhoff, Rockwell Automation and B&amp;R. More information on the FBF can be found <a _blank"="" href="https://fbf.cloud.sick.com target=">here</a>.</li><li>• <b>Note:</b> You can configure your function block at <a _blank"="" href="https://fbf.cloud.sick.com target=">Function Block Factory</a>. As a login please use your SICK ID.</li></ul>	Function Block Factory	On request

## SICK AT A GLANCE

SICK is one of the leading manufacturers of intelligent sensors and sensor solutions for industrial applications. A unique range of products and services creates the perfect basis for controlling processes securely and efficiently, protecting individuals from accidents and preventing damage to the environment.

We have extensive experience in a wide range of industries and understand their processes and requirements. With intelligent sensors, we can deliver exactly what our customers need. In application centers in Europe, Asia and North America, system solutions are tested and optimized in accordance with customer specifications. All this makes us a reliable supplier and development partner.

Comprehensive services complete our offering: SICK LifeTime Services provide support throughout the machine life cycle and ensure safety and productivity.

For us, that is “Sensor Intelligence.”

## WORLDWIDE PRESENCE:

Contacts and other locations –[www.sick.com](http://www.sick.com)