

# TTK50-HXQ0-K02

TTK50

LINEAR MOTOR FEEDBACK SYSTEMS

**SICK**  
Sensor Intelligence.

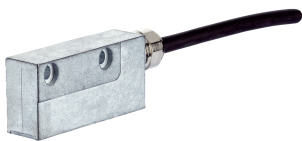

Illustration may differ

### Ordering information

Type	Part no.
TTK50-HXQ0-K02	1057793

Magnetic tape not included with delivery

Other models and accessories → [www.sick.com/TTK50](http://www.sick.com/TTK50)



### Detailed technical data

#### Features

<b>Items supplied</b>	Magnetic tape not included with delivery
-----------------------	--

#### Performance

<b>Measuring step</b>	0.244 µm For interpolation of the sine/cosine signals with, e. g., 12 bits
<b>Measuring range</b>	0 mm ... 940 mm
<b>Resolution</b>	1 µm
<b>Length of period</b>	1 mm
<b>Traversing speed</b>	1.3 m/s, ≤ 10 m/s up to which the absolute position can be reliably produced, dynamic operation (Sin/Cos)
<b>Repeatability</b>	< 5 µm
<b>System accuracy</b>	± 10 µm (+20 °C)
<b>Measured value backlash</b>	< 10 µm

#### Interfaces

<b>Code type</b>	Binary
<b>Available memory area</b>	1,972 Byte (E <sup>2</sup> PROM 2048)

#### Electrical data

<b>Supply voltage</b>	7 V DC ... 12 V DC
<b>Recommended supply voltage</b>	8 V DC
<b>Operating current</b>	≤ 55 mA (without load) <sup>1)</sup>
<b>Connection type</b>	Cable, 8-wire (4 x 2 x 0.15 mm <sup>2</sup> ), 2 m

<sup>1)</sup> 100 mA approx. during adjustment.

#### Mechanical data

<b>Dimensions</b>	See dimensional drawing
<b>Scope of delivery</b>	Magnetic tape not included with delivery
<b>Weight</b>	0.06 kg, without cable
<b>Read head material</b>	Zinc diecast

## Ambient data

<b>EMC</b>	According to EN 61000-6-2 and EN 61000-6-3 <sup>1)</sup>
<b>Enclosure rating</b>	IP67, with mating connector inserted (IEC 60529)
<b>Operating temperature range</b>	-30 °C ... +80 °C
<b>Storage temperature range</b>	-40 °C ... +85 °C, without package
<b>Permissible relative humidity</b>	100 %, condensation permitted
<b>Resistance to shocks</b>	30 g, 6 ms (EN 60068-2-27)
<b>Resistance to vibration</b>	20 g, 10 Hz ... 2,000 Hz (EN 60068-2-6)
<b>Maximum permitted ambient field strength</b>	< 3 kA/m ... 4 kA/m (3.8 mT ... 5 mT), to guarantee compliance with the quoted accuracy values <sup>2)</sup>
<b>Maximum permitted field strength</b>	< 150 kA/m (< 190 mT), to ensure that the magnetic tape is not permanently damaged

<sup>1)</sup> According to the listed standards, EMC is guaranteed if the motor feedback system is connected to the central grounding point of the motor controller via a cable shield and the encoder housing lays over a large area of the motor potential. If other shielding concepts are used, users must perform their own test.

<sup>2)</sup> The maximum permitted external field influence is reached when the position value deviates from the original value (without external field influence) by more than 5 µm. This value is reached when, at the sensor location, a field strength of 3 kA/m to 4 kA/m (3.8 mT to 5 mT) occurs in addition to the field strength of the magnetic tape.

## Classifications

<b>eCl@ss 5.0</b>	27270590
<b>eCl@ss 5.1.4</b>	27270590
<b>eCl@ss 6.0</b>	27270590
<b>eCl@ss 6.2</b>	27270590
<b>eCl@ss 7.0</b>	27270590
<b>eCl@ss 8.0</b>	27270590
<b>eCl@ss 8.1</b>	27270590
<b>eCl@ss 9.0</b>	27270590
<b>eCl@ss 10.0</b>	27273805
<b>eCl@ss 11.0</b>	27273902
<b>eCl@ss 12.0</b>	27273902
<b>ETIM 5.0</b>	EC001486
<b>ETIM 6.0</b>	EC001486
<b>ETIM 7.0</b>	EC001486
<b>ETIM 8.0</b>	EC001486
<b>UNSPSC 16.0901</b>	41112113

**Dimensional drawing** (Dimensions in mm (inch))

Read head

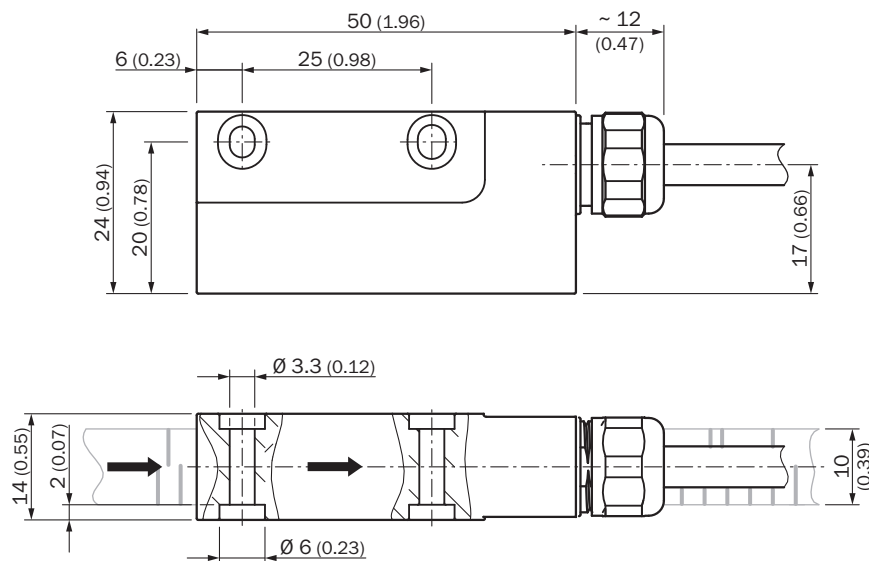

**Position tolerance**

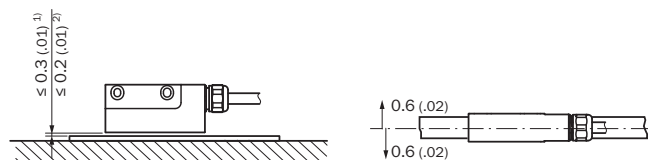









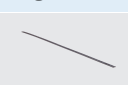

General tolerances according to DIN ISO 2768-mk

- ① Without cover strip
- ② With cover strip

**Recommended accessories**

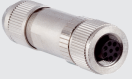
Other models and accessories → [www.sick.com/TTK50](http://www.sick.com/TTK50)

	Brief description	Type	Part no.
<b>Magnets</b>			
	Magnetic tape length: 1 m, magnetic tape width: 10 mm, weight: 0.18 kg/m, magnetic tape material: 17410 hard ferrite 9/28 P, substrate tape material: steel, period length 1 mm, operating temperature range: -20 °C ... 100 °C, storage temperature range: -30 °C ... 100 °C, temperature coefficient: (11 ± 1) µm/K/m	MVM-1MO-2MC-MKLB	6049001
<b>Programming and configuration tools</b>			
	SVip® LAN programming tool for all motor feedback systems	PGT-11-S LAN	1057324
<b>Plug connectors and cables</b>			
	LTG-2708-MW	LTG-2708-MW	6028361

	<b>Brief description</b>	<b>Type</b>	<b>Part no.</b>
	Head A: female connector, M23, 12-pin, straight Head B: male connector, M23, 17-pin, straight Cable: HIPERFACE <sup>®</sup> , unshielded, 1 m	DSL-2317-G01MJB2	2071328
	Head A: female connector, JST, 8-pin, straight Head B: male connector, M23, 17-pin, straight Cable: HIPERFACE <sup>®</sup> , unshielded, 1 m	DSL-2317-G01MJB6	2071327
	Head A: female connector, M12, 8-pin, straight Head B: male connector, M23, 17-pin, straight Cable: HIPERFACE <sup>®</sup> , unshielded, 1 m	DSL-2317-G01MJC1	2071329
	Head A: female connector, terminal box, 8-pin, straight Head B: male connector, M23, 17-pin, straight Cable: HIPERFACE <sup>®</sup> , unshielded, 1 m	DSL-2317-G01MJC6	2071330
	Head A: female connector, M12, 8-pin, straight Cable: shielded	DOS-1208-GA	6028369
	Head A: female connector, M12, 8-pin, straight, A-coded Cable: Incremental, SSI, shielded	DOS-1208-GA01	6045001
	Head A: female connector, M12, 8-pin, angled, A-coded Cable: Ethernet, shielded	DOS-1208-WA	6043358
	Head A: male connector, M12, 8-pin, straight Cable: shielded	STE-1208-GA	6028370
	Head A: male connector, M12, 8-pin, straight, A-coded Cable: Incremental, shielded	STE-1208-GA01	6044892

## SICK AT A GLANCE

SICK is one of the leading manufacturers of intelligent sensors and sensor solutions for industrial applications. A unique range of products and services creates the perfect basis for controlling processes securely and efficiently, protecting individuals from accidents and preventing damage to the environment.

We have extensive experience in a wide range of industries and understand their processes and requirements. With intelligent sensors, we can deliver exactly what our customers need. In application centers in Europe, Asia and North America, system solutions are tested and optimized in accordance with customer specifications. All this makes us a reliable supplier and development partner.

Comprehensive services complete our offering: SICK LifeTime Services provide support throughout the machine life cycle and ensure safety and productivity.

For us, that is “Sensor Intelligence.”

## WORLDWIDE PRESENCE:

Contacts and other locations –[www.sick.com](http://www.sick.com)