



	230 V~
	50 Hz
	2.5 mm ²
	-10° / +30°C
	PIR
	20 min.
	Auto ON / OFF
	2.8 m Ø 15 m

L/OUT										LED		
230 V~	2 x 6A	2 x 6A	2 x 6A	2 x 6A	2 x 6A	2 x 6A	2 x 6A	2 x 6A	2 x 6A	2 x 6A	2 x 6A	2 x 6A



Sortie 1 + Sortie 2 = 10 A max
 Channel 1 + Channel 2 = 10 A max
 Canale 1 + Canale 2 = 10 A max

Exemple => Sortie 1 (4A) + Sortie 2 (6A) = 10 A max
 Example => Channel 1 (4A) + Channel 2 (6A) = 10 A max
 Esempio => Canale 1 (4A) + Canale 2 (6A) = 10 A max

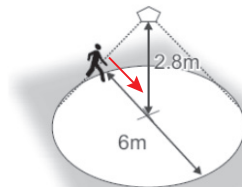

- Approche axiale
- Walk towards
- Camminare verso

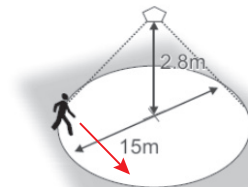

- Approche transversale
- Walk across
- Attraversare



Sensibilité maximum
 Maximal sensitivity **9**
 Massima sensibilità

Hauteur Height Altezza	Diamètre Diameter Diametro
2.5 m	5 m

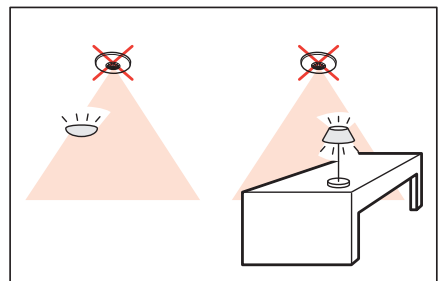
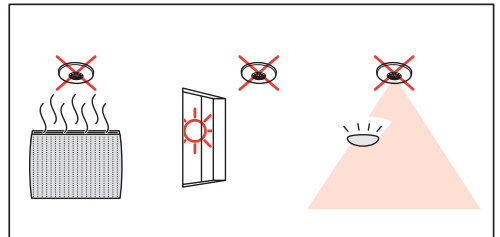
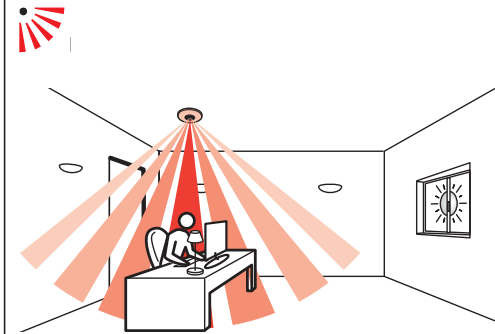
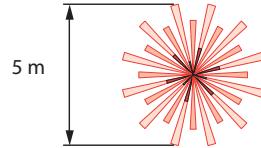

- Deux canaux de commutation
- Two switching channels
- Due canali di commutazione

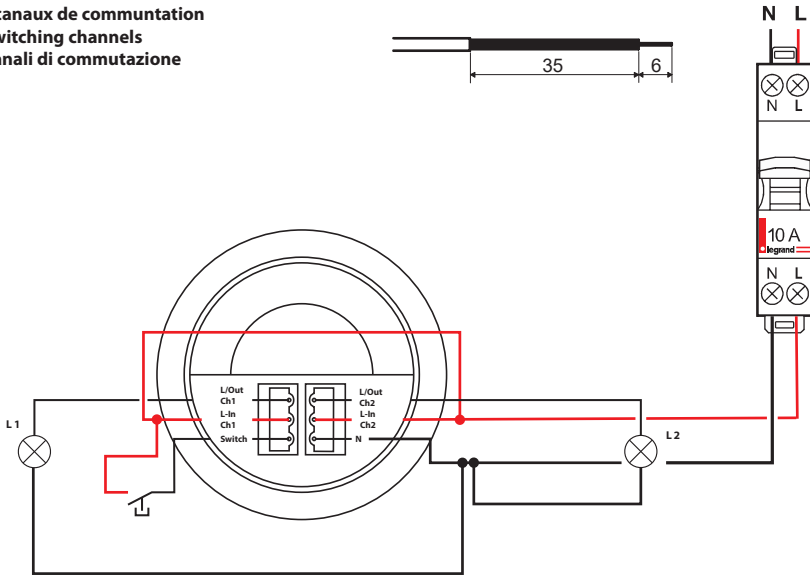

- Câblage et raccordement du bornier au détecteur
- Cablaggio e connessione al rilevatore
- Wire in plugs & connecto detector

Perçer un trou de 64 mm de diamètre dans le plafond.
 Realizzare un foro di 64 mm di diametro a soffitto.
 Cut a 64 mm diameter hole in the ceiling

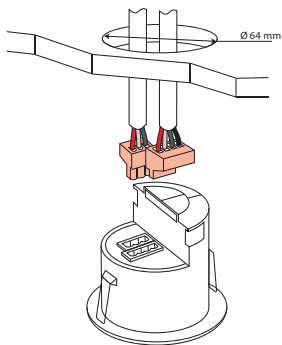

- Serrer les câbles
- Morsetto per il cavo
- Clamp cable

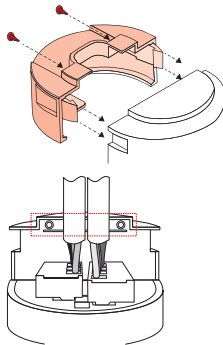

- Installer le détecteur
- Instalação de detector
- Install detector

Pour éviter toute blessure, faire attention lors de la compression des ressorts.
 Per evitare infortuni, prestare attenzione quando si piegano le molle.
 To avoid injury, take care when bending springs.

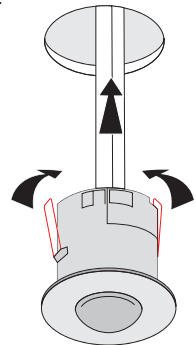

Auto ON / OFF





Manual ON / Auto OFF

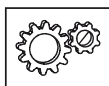
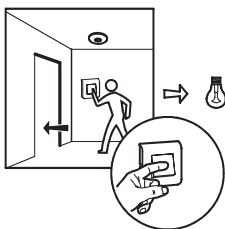
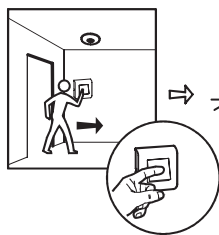

- À la première utilisation: Télécharger l'application Legrand Close Up sur l' Apple Store ou le Play Store.
- On first use: Download the Legrand Close Up app from Apple Store or Play Store
- Al primo utilizzo: Scaricare l'app Legrand Close Up su Apple Store o Play Store.

- Réf. 0 882 40 : Passerelle de configuration
- Cat. No(s) 0 882 40 : Configuration tool
- Ref. 0 882 40: Gateway di configurazione



&



Application: «Legrand Close Up»



App Store



Google Play



- Pour plus de renseignement sur les paramètres, reportez vous à la fiche technique de la passerelle de configuration Réf. 0 882 40.
- For more information about setting parameters, refer to the data sheet for the configuration gateway Cat. No. 0 882 40.
- Per maggiori informazioni sulle impostazioni, consultare la scheda tecnica del gateway di configurazione Ref. 0 882 40.

	0 - 999
	10s - 99 min.
	1 - 9
Mode	Auto - Manual

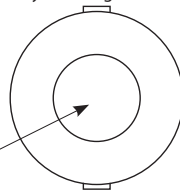

- Lentille PIR / récepteur IR / capteur de luminosité / LED d'état
- PIR lens / IR Receiver / Light Level Sensor / Status LED
- Lente PIR / ricevitore IR / sensore luminosità / stato LED

- Pour la configuration, il est nécessaire d'effectuer une opération d'initialisation proposée dans l'application de configuration Legrand Close Up :

1 – cliquer sur "lecture des paramètres produits"

2 – cliquer sur "détails de paramètres / copier"

3 – dans le menu en haut à droite (...) sélectionner "Initialiser"

4 – cliquer sur "écriture des paramètres produits"

Cette opération permet le réglage prédéfini de certains paramètres.

- For configuration, it is necessary to operate an operation for initialization proposed in the Legrand Close Up application:

1 – click on "new scan"

2 – click on "see details"

3 – from the menu at the top right (...) select the action "Initialise"

4 – click on "upload configuration"

This operation allows the predefined setting of some parameters.

- Per la configurazione, è necessario eseguire un'operazione di inizializzazione proposta nell'applicazione Legrand Close Up:

1 – clicca su "leggi i parametri del prodotto"

2 – clicca su "dettagli parametro"

3 – dal menu in alto a destra (...) selezionare "Inizializza"

4 – clicca su "scrivi parametri prodotto"

Questa operazione consente l'impostazione predefinita di alcuni parametri.